

## Table of Contents

<b>Introduction</b>	<b>4</b>
<b>Instrument Cluster</b>	<b>12</b>
Warning lights and chimes	12
Gauges	17
Trip computer	18
Message center	18
Multifunction display	20
<b>Entertainment Systems</b>	<b>24</b>
AM/FM stereo with CD	24
Auxiliary input jack (Line in)	33
USB port	35
Satellite radio information	39
SYNC®	42
Privacy Information	44
Pairing your phone for the first time	48
Connecting a digital media player to SYNC®	76
<b>Climate Controls</b>	<b>101</b>
Manual heating and air conditioning	101
Rear window defroster	103
<b>Lights</b>	<b>105</b>
Headlamps	105
Turn signal control	108
Interior lamps	108
Bulb replacement	110
<b>Driver Controls</b>	<b>120</b>
Windshield wiper/washer control	120
Steering wheel adjustment	121
Power windows	122
Mirrors	124
Speed control	126

## Table of Contents

### Locks and Security 131

Keys	131
Locks	133
Anti-theft system	144

### Seating and Safety Restraints 147

Seating	147
Head restraints	147
Personal Safety System™	156
Safety belt system	159
Airbags	170
Child restraints	186

### Tires, Wheels and Loading 205

Tire information	205
Tire inflation	207
Tire Pressure Monitoring System (TPMS)	220
Vehicle loading	224
Trailer towing	230
Recreational towing	230

### Driving 233

Starting	233
Brakes	240
AdvanceTrac®	243
Transmission operation	249
Automatic transmission	251

### Roadside Emergencies 258

Getting roadside assistance	258
Hazard flasher control	259
Fuel pump shut-off	260
Fuses and relays	260
Changing tires	268
Wheel lug nut torque	273
Jump starting	274
Wrecker towing	277

## Table of Contents

<b>Customer Assistance</b>	<b>279</b>
Reporting safety defects (U.S. only)	286
Reporting safety defects (Canada only)	286
<b>Cleaning</b>	<b>287</b>
<b>Maintenance and Specifications</b>	<b>294</b>
Engine compartment	296
Engine oil	298
Battery	300
Engine coolant	302
Fuel information	307
Air filter(s)	320
Part numbers	324
Maintenance product specifications and capacities	325
Engine data	327
<b>Accessories</b>	<b>331</b>
<b>Ford Extended Service Plan</b>	<b>333</b>
<b>Scheduled Maintenance</b>	<b>337</b>
Normal scheduled maintenance and log	343
<b>Index</b>	<b>354</b>

The information contained in this publication was correct at the time of going to print. In the interest of continuous development, we reserve the right to change specifications, design or equipment at any time without notice or obligation. No part of this publication may be reproduced, transmitted, stored in a retrieval system or translated into any language in any form by any means without our written permission. Errors and omissions excepted.

© Ford Motor Company 2011

<https://www.MyCarManual.com>

3

## Introduction

### CONGRATULATIONS

Congratulations on acquiring your new Ford. Please take the time to get well acquainted with your vehicle by reading this handbook. The more you know and understand about your vehicle, the greater the safety and pleasure you will derive from driving it.

For more information on Ford Motor Company and its products visit the following website:

- In the United States: [www.ford.com](http://www.ford.com)
- In Canada: [www.ford.ca](http://www.ford.ca)
- In Australia: [www.ford.com.au](http://www.ford.com.au)
- In Mexico: [www.ford.com.mx](http://www.ford.com.mx)

Additional owner information is given in separate publications.

This Owner's Guide describes every option and model variant available and therefore some of the items covered may not apply to your particular vehicle. Furthermore, due to printing cycles it may describe options before they are generally available.

Remember to pass on this Owner's Guide when reselling the vehicle. It is an integral part of the vehicle.



**WARNING: Fuel pump shut-off:** In the event of an accident this feature will automatically cut off the fuel supply to the engine. It can also be activated through sudden vibration (e.g. collision when parking). To restart your vehicle, refer to *Fuel pump shut-off* in the *Roadside Emergencies* chapter.

### SAFETY AND ENVIRONMENT PROTECTION



#### Warning symbols in this guide

How can you reduce the risk of personal injury to yourself or others? In this guide, answers to such questions are contained in comments highlighted by the warning triangle symbol. These comments should be read and observed.

## Introduction

### **Warning symbols on your vehicle**

When you see this symbol, it is imperative that you consult the relevant section of this guide before touching or attempting adjustment of any kind.



### **Protecting the environment**

We must all play our part in protecting the environment. Correct vehicle usage and the authorized disposal of waste, cleaning and lubrication materials are significant steps toward this aim. Information in this respect is highlighted in this guide with the tree symbol.



### **CALIFORNIA PROPOSITION 65 WARNING**

 **WARNING:** Engine exhaust, some of its constituents, and certain vehicle components contain or emit chemicals known to the State of California to cause cancer and birth defects or other reproductive harm. In addition, certain fluids contained in vehicles and certain products of component wear contain or emit chemicals known to the State of California to cause cancer and birth defects or other reproductive harm.

### **PERCHLORATE MATERIAL**

Certain components of this vehicle such as airbag modules, safety belt pretensioners, and button cell batteries may contain Perchlorate Material – Special handling may apply for service or vehicle end of life disposal. See [www.dtsc.ca.gov/hazardouswaste/perchlorate](http://www.dtsc.ca.gov/hazardouswaste/perchlorate).

### **BREAKING-IN YOUR VEHICLE**

Your vehicle does not need an extensive break-in. Try not to drive continuously at the same speed for the first 1,000 miles (1,600 km) of new vehicle operation. Vary your speed frequently in order to give the moving parts a chance to break in.

Do not add friction modifier compounds or special break-in oils since these additives may prevent piston ring seating. See *Engine oil* in the *Maintenance and Specifications* chapter for more information on oil usage.

## Introduction

### SPECIAL NOTICES

#### New Vehicle Limited Warranty

For a detailed description of what is covered and what is not covered by your vehicle's New Vehicle Limited Warranty, refer to the *Warranty Guide* that is provided to you along with your Owner's Guide.

#### Special instructions

For your added safety, your vehicle is fitted with sophisticated electronic controls.



**WARNING:** Please read the section *Airbag Supplemental Restraint System (SRS)* in the *Seating and Safety Restraints* chapter. Failure to follow the specific warnings and instructions could result in personal injury.



**WARNING:** Front seat mounted rear-facing child or infant seats should **NEVER** be placed in front of an active passenger airbag.

### DATA RECORDING

#### Service Data Recording

Service data recorders in your vehicle are capable of collecting and storing diagnostic information about your vehicle. This potentially includes information about the performance or status of various systems and modules in the vehicle, such as engine, throttle, steering or brake systems. In order to properly diagnose and service your vehicle, Ford Motor Company, Ford of Canada, and service and repair facilities may access or share among them vehicle diagnostic information received through a direct connection to your vehicle when diagnosing or servicing your vehicle. For U.S. only (if equipped), if you choose to use the SYNC® Vehicle Health Report, you consent that certain diagnostic information may also be accessed electronically by Ford Motor Company and Ford authorized service facilities, and that the diagnostic information may be used for any purpose. See your SYNC® supplement for more information.

#### Event Data Recording

**This vehicle is equipped with an event data recorder (EDR). The main purpose of an EDR is to record, in certain crash or near crash-like situations, such as an airbag deployment or hitting a**

## Introduction

road obstacle; this data will assist in understanding how a vehicle's systems performed. The EDR is designed to record data related to vehicle dynamics and safety systems for a short period of time, typically 30 seconds or less. The EDR in this vehicle is designed to record such data as:

- How various systems in your vehicle were operating;
- Whether or not the driver and passenger safety belts were buckled/fastened;
- How far (if at all) the driver was depressing the accelerator and/or the brake pedal; and
- How fast the vehicle was travelling; and
- Where the driver was positioning the steering wheel.

This data can help provide a better understanding of the circumstances in which crashes and injuries occur.

**Note:** EDR data is recorded by your vehicle only if a non-trivial crash situation occurs; no data is recorded by the EDR under normal driving conditions and no personal data or information (e.g., name, gender, age, and crash location) is recorded (see limitations regarding 911 Assist and Traffic, directions and Information privacy below). However, parties, such as law enforcement, could combine the EDR data with the type of personally identifying data routinely acquired during a crash investigation.

To read data recorded by an EDR, special equipment is required, and access to the vehicle or the EDR is needed. In addition to the vehicle manufacturer, other parties, such as law enforcement, that have such special equipment, can read the information if they have access to the vehicle or the EDR. Ford Motor Company and Ford of Canada do not access event data recorder information without obtaining consent, unless pursuant to court order or where required by law enforcement, other government authorities or other third parties acting with lawful authority. Other parties may seek to access the information independently of Ford Motor Company and Ford of Canada.

**Note:** Including to the extent that any law pertaining to Event Data Recorders applies to SYNC® or its features, please note the following: Once 911 Assist (if equipped) is enabled (set ON), 911 Assist may, through any paired and connected cell phone, disclose to emergency services that the vehicle has been in a crash

## Introduction

involving the deployment of an airbag or, in certain vehicles, the activation of the fuel pump shut-off. Certain versions or updates to 911 Assist may also be capable of being used to electronically or verbally provide to 911 operators the vehicle location (such as latitude and longitude), and/or other details about the vehicle or crash or personal information about the occupants to assist 911 operators to provide the most appropriate emergency services. If you do not want to disclose this information, do not activate the 911 Assist feature. See your SYNC® supplement for more information.

Additionally, when you connect to Traffic, Directions and Information (if equipped, U.S. only), the service uses GPS technology and advanced vehicle sensors to collect the vehicle's current location, travel direction, and speed ("vehicle travel information"), only to help provide you with the directions, traffic reports, or business searches that you request. If you do not want Ford or its vendors to receive this information, do not activate the service. Ford Motor Company and the vendors it uses to provide you with this information do not store your vehicle travel information. For more information, see Traffic, Directions and Information, Terms and Conditions. See your SYNC® supplement for more information.

### CELL PHONE USE

The use of mobile communications equipment has become increasingly important in the conduct of business and personal affairs. However, drivers must not compromise their own or others' safety when using such equipment. Mobile communications can enhance personal safety and security when appropriately used, particularly in emergency situations. Safety must be paramount when using mobile communications equipment to avoid negating these benefits.

Mobile communication equipment includes, but is not limited to, cellular phones, pagers, portable email devices, text messaging devices and portable two-way radios.



**WARNING:** Driving while distracted can result in loss of vehicle control, accident and injury. Ford strongly recommends that you use extreme caution when using any device or feature that may take your focus off the road. Your primary responsibility is the safe operation of your vehicle. We recommend against the use of any handheld device while driving and that you comply with all applicable laws.



## Introduction

















### **EXPORT UNIQUE (NON-UNITED STATES/CANADA) VEHICLE SPECIFIC INFORMATION**

For your particular global region, your vehicle may be equipped with features and options that are different from the features and options that are described in this Owner's Guide. A market unique supplement may be supplied that complements this book. By referring to the market unique supplement, if provided, you can properly identify those features, recommendations and specifications that are unique to your vehicle. This Owner's Guide is written primarily for the U.S. and Canadian Markets. Features or equipment listed as standard may be different on units built for Export. **Refer to this Owner's Guide for all other required information and warnings.**

## Introduction











These are some of the symbols you may see on your vehicle.

### Vehicle Symbol Glossary

Safety Alert		See Owner's Guide	
Fasten Safety Belt		Airbag - Front	
Airbag - Side		Child Seat Lower Anchor	
Child Seat Tether Anchor		Brake System	
Anti-Lock Brake System		Parking Brake System	
Brake Fluid - Non-Petroleum Based		Parking Aid System	
Stability Control System		Speed Control	
Master Lighting Switch		Hazard Warning Flasher	
Fog Lamps-Front		Fuse Compartment	
Fuel Pump Reset		Windshield Wash/Wipe	
Windshield Defrost/Demist		Rear Window Defrost/Demist	

## Introduction

### Vehicle Symbol Glossary

Power Windows Front/Rear		Power Window Lockout	
Child Safety Door Lock/Unlock		Interior Luggage Compartment Release	
Panic Alarm		Engine Oil	
Engine Coolant		Engine Coolant Temperature	
Do Not Open When Hot		Battery	
Avoid Smoking, Flames, or Sparks		Battery Acid	
Explosive Gas		Fan Warning	
Power Steering Fluid		Maintain Correct Fluid Level	
Service Engine Soon		Engine Air Filter	
Passenger Compartment Air Filter		Jack	
Check Fuel Cap		Low Tire Pressure Warning	

## Instrument Cluster

### WARNING LIGHTS AND CHIMES

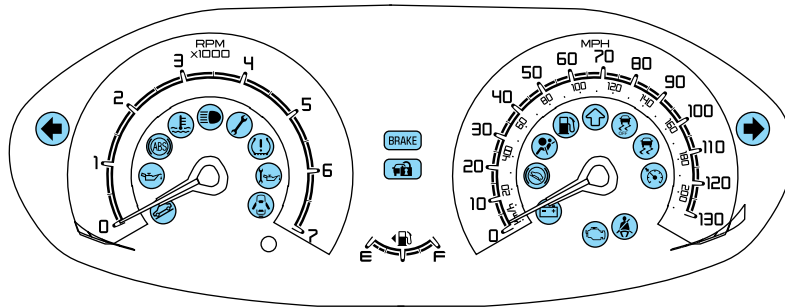

Warning lights can alert you to a vehicle condition that may become serious enough to cause expensive repairs. A warning light may illuminate when a problem exists with one of your vehicle's functions. Many lights will illuminate when you start your vehicle to make sure the bulb works. If any light remains on after starting the vehicle, refer to the respective system warning light for additional information.

**Service engine soon:** The service engine soon indicator  illuminates when the ignition is first turned to the on position to check

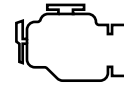

the bulb and to indicate whether the vehicle is ready for Inspection/Maintenance (I/M) testing. Normally, the service engine soon indicator will stay on until the engine is cranked, then turn itself off if no malfunctions are present. However, if after 15 seconds the service engine soon indicator blinks eight times, it means that the vehicle is not ready for I/M testing. See the *Readiness for Inspection/Maintenance (I/M) testing* in the *Maintenance and Specifications* chapter.

Solid illumination after the engine is started indicates the on-board diagnostics system (OBD-II) has detected a malfunction. Refer to *On-board diagnostics (OBD-II)* in the *Maintenance and Specifications* chapter. If the light is blinking, engine misfire is occurring which could damage your catalytic converter. Drive in a moderate fashion (avoid heavy acceleration and deceleration) and have your vehicle serviced immediately by your authorized dealer.

## Instrument Cluster



**WARNING:** Under engine misfire conditions, excessive exhaust temperatures could damage the catalytic converter, the fuel system, interior floor coverings or other vehicle components, possibly causing a fire.

**Low fuel:** Displays when the fuel level in the fuel tank is at or near empty (refer to *Fuel gauge* in this chapter).



**Powertrain malfunction/Reduced power/Electronic throttle control:**

Displays when the engine has defaulted to a “limp-home” operation or when a transmission problem has been detected and shifting may be restricted. If the light remains on, have the system serviced immediately by your authorized dealer.



**Brake system warning light:** To confirm the brake system warning light is functional, it will momentarily illuminate when the ignition is turned to the on position when the engine is not running, or in a position between on and start, or by applying the parking brake when the ignition is turned to the on position.

**BRAKE**

If the brake system warning light does not illuminate at this time, seek service immediately from your authorized dealer. Illumination after releasing the parking brake indicates low brake fluid level and the brake system should be inspected immediately by your authorized dealer.



**WARNING:** Driving a vehicle with the brake system warning light on is dangerous. A significant decrease in braking performance may occur. It will take you longer to stop the vehicle. Have the vehicle checked by your authorized dealer. Driving extended distances with the parking brake engaged can cause brake failure and the risk of personal injury.

## Instrument Cluster

**Anti-lock brake system:** If the ABS light stays illuminated or continues to flash, a malfunction has been detected, have the system serviced immediately by your authorized dealer. Normal braking is still functional unless the brake warning light also is illuminated.

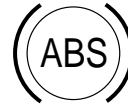

**Airbag readiness:** If this light fails to illuminate when the ignition is turned to on, continues to flash or remains on, have the system serviced immediately by your authorized dealer. A chime will sound if there is a malfunction in the indicator light.



**Safety belt:** Reminds you to fasten your safety belt. A Belt-Minder® chime will also sound to remind you to fasten your safety belt. Refer to the *Seating and Safety Restraints* chapter to activate/deactivate the Belt-Minder® chime feature.



**Charging system:** Illuminates when the battery is not charging properly. If it stays on while the engine is running, there may be a malfunction with the charging system. Contact your authorized dealer as soon as possible. This indicates a problem with the electrical system or a related component.



**Engine oil pressure:** Displays when the oil pressure falls below the normal range. Refer to *Engine oil* in the *Maintenance and Specifications* chapter.

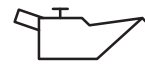

**Oil change reminder:** Displays when the engine oil life has expired. Refer to *Oil life monitoring system reset* later in this chapter.



**Door ajar:** Displays when the ignition is in the on position and any door is not completely closed.



## Instrument Cluster

### Engine coolant temperature:

Illuminates when the engine coolant temperature is high. Stop the vehicle as soon as possible, switch off the engine and let cool. Refer to *Engine coolant* in the *Maintenance and Specifications* chapter.



**WARNING:** Never remove the coolant reservoir cap while the engine is running or hot.

### Low tire pressure warning:

Illuminates when your tire pressure is low. If the light remains on at start up or while driving, the tire pressure should be checked. Refer to *Inflating your tires* in the *Tires, Wheels and Loading* chapter. When the ignition is first turned to on, the light will illuminate for three seconds to ensure the bulb is working. If the light does not turn on, have the system inspected by your authorized dealer. For more information on this system, refer to *Tire pressure monitoring system (TPMS)* in the *Tires, Wheels and Loading* chapter.

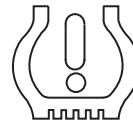

### Hill start assistance (if equipped):

Displays when using hill start assist is not available. Refer to the *Driving* chapter for transmission function and operation.



### Overdrive cancel and grade assist (if equipped):

Illuminates when the overdrive function of the transmission has been turned off and the grade assist function has been turned on, refer to the *Driving* chapter.



### Upshift (manual transmission):

To maximize fuel economy, this light illuminates when the manual transmission should be shifted to the next highest gear. Refer to the *Driving* chapter for more information.



## Instrument Cluster

**AdvanceTrac®/Traction control (if equipped):** Displays when the AdvanceTrac®/Traction control is active. If the light remains on, have the system serviced immediately, refer to the *Driving* chapter for more information.



**AdvanceTrac®/Traction control off light (if equipped):** Illuminates when AdvanceTrac®/Traction control has been disabled by the driver. Refer to the *Driving* chapter for more information.



**Speed control (if equipped):** Illuminates when the speed control system is in use.

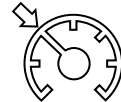

**Anti-theft system:** Flashes when the SecuriLock® Passive Anti-theft System has been activated.



**Turn signal:** Illuminates when the left or right turn signal or the hazard lights are turned on. If the indicators stay on or flash faster, check for a burned out bulb.



**High beams:** Illuminates when the high beam headlamps are turned on.



**Key-in-ignition warning chime:** Sounds when the key is left in the ignition in the off or accessory position and the driver's door is opened.

**Headlamps on warning chime:** Sounds when the headlamps or parking lamps are on, the ignition is off (the key is not in the ignition) and the driver's door is opened.



## Instrument Cluster

### GAUGES

Shown in standard measure. Metric similar.

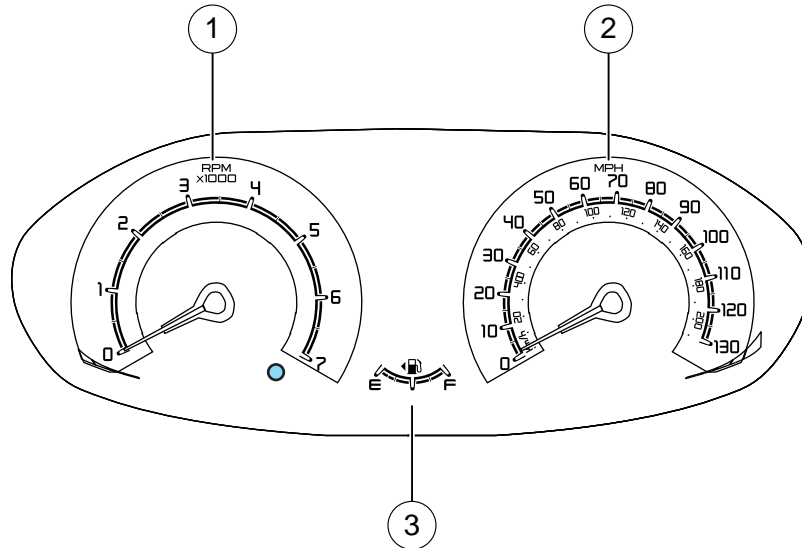

1. **Tachometer:** Indicates the engine speed in revolutions per minute. Driving with your tachometer pointer continuously at the top of the scale may damage the engine.

Refer to *Filling the tank* in the *Maintenance and Specifications* chapter for more information.

2. **Speedometer:** Indicates the current vehicle speed.

3. **Fuel gauge:** Indicates approximately how much fuel is left in the fuel tank (when the ignition is in the on position). The fuel gauge may vary slightly when the vehicle is in motion or on a grade. The fuel icon and arrow indicates which side of the vehicle the fuel filler door is located.

## Instrument Cluster

### TRIP COMPUTER (IF EQUIPPED)

Press the end of the lever, located on the left side of the steering wheel to scroll through the displays.

To reset the trip odometer and average speed, scroll to the required display and press and hold the end of the multifunction lever.

The trip computer includes the following information displays:



### MI (KM) TRIP — TRIP ODOMETER

Registers the distance of individual journeys.

### MI (KM) TO E — DISTANCE TO EMPTY (IF EQUIPPED)

Indicates the approximate distance the vehicle will travel on the fuel remaining in the tank. Changes in driving pattern may cause the value to vary.

### AVG MPG (L/100KM) — AVERAGE FUEL CONSUMPTION (IF EQUIPPED):

Indicates the average fuel consumption since the function was last reset.

**Note:** After resetting, the display will show two dashes for several seconds while it recalculates a new value.

### AVG MPH (KM/H) — AVERAGE SPEED (IF EQUIPPED)

Indicates the average speed calculated since the function was last reset.

### MULTIFUNCTION DISPLAY

Your vehicle's multifunction display is capable of monitoring many vehicle systems and will alert you to potential vehicle problems and various conditions with an informational message. You can also program various vehicle settings using the message center.

The display is located in the center stack.

## Instrument Cluster

Certain settings can be changed through the multifunction display. Press MENU on the audio system to access the settings screen.

Press ▲ / ▼ / ◀ / ▶ to move through the display screen. The following settings can be changed:



**Audio:** See *Audio systems* in the *Entertainment Systems* chapter for more information.

**Vehicle:** Select Vehicle then move right to enter into the menu. Scroll up or down to select from:

- **Traction Control:** Move right to enter the menu and then move up or down to select from on or off. Press OK to confirm.
- **Chimes:** Move right to enter the menu, then up or down to select from warning chimes or info chimes. Press OK to confirm.
- **Lane change indicator/Turn indicator:** Move right to enter the menu and then move up or down to select from flash once or flash three times. Press OK to confirm.
- **Chimes:** Move right to enter the menu, then up or down to select from warning chimes or info chimes. Press OK to confirm.

**Clock:** Select Clock then move right to enter the menu. Scroll up or down to select from to select from:

- **Set time:** Move right to enter the menu and adjust the time.
- **Set date:** Move right to enter the menu and adjust the date.
- **24 hour mode:** Move right to enter the menu to choose 24-hour mode.

The clock can also be set through the audio system. See *Audio systems* in the *Entertainment Systems* chapter for more information.

**Display:** Select Display then move right to enter the menu. Scroll up or down to select from:

- **Units of measure:** Move right to enter the menu then move up or down to select metric or standard.
- **Language:** Move right to enter the menu then move up or down to select the desired language.

**Messages:** Select messages, then move up/down to view stored messages.

**Compass (if equipped):** If your vehicle is equipped with SYNC®, the compass heading is displayed to the left of the clock in the upper portion of the multifunction display.

## Instrument Cluster

### Information messages





**i** : The message indicator will illuminate when there is a new message stored in the multifunction display.

Message	Warning Lamp at Instrument Cluster	System
<b>ABS MALFUNCTION SERVICE NOW</b>	(ABS)	ABS
<b>ESP OFF</b>	—	ABS
<b>ESP MALFUNCTION NEXT SERVICE</b>	—	ABS
<b>BRAKE SYSTEM MALFUNCTION STOP SAFELY</b>	BRAKE or (!)	Brakes
<b>ALARM SYSTEM MALFUNCTION NEXT SERVICE</b>	—	Anti-theft security system
<b>INTERIOR SCAN DEACTIVATED</b>	—	Anti-theft security system
<b>IMMOBILIZER MALFUNCTION SERVICE NOW</b>	—	Anti-theft security system
<b>ALARM TRIGGERED CHECK VEHICLE</b>	—	Anti-theft security system
<b>LEFT/RIGHT INDICATOR MALFUNCTION CHANGE BULB</b>	—	Lights
<b>HILL START ASSIST NOT AVAILABLE</b>	(S)	Transmission
<b>STEERING LOCK ENGAGED TURN STEERING WHEEL</b>	—	Passive Entry/Passive Start



## Instrument Cluster

Message	Warning Lamp at Instrument Cluster	System
<b>STEERING MALFUNCTION SERVICE NOW</b>	—	Passive Entry/Passive Start
<b>STEERING MALFUNCTION STOP SAFELY</b>	—	Passive Entry/Passive Start
<b>POWER STEERING MALFUNCTION SERVICE NOW</b>	—	Power Steering
<b>KEY NOT DETECTED</b>	—	Passive entry/passive start system
<b>TURN IGNITION OFF USE POWER BUTTON</b>	—	Passive entry/passive start system
<b>KEY OUTSIDE CAR</b>	—	Passive entry/passive start system
<b>KEY BATTERY LOW REPLACE BATTERY</b>	—	Passive entry/passive start system
<b>TO START PRESS BRAKE</b>	—	Passive Entry/Passive Start
<b>CLOSE TRUNK OR USE SPARE KEY</b>	—	Trunk
<b>TO START PRESS CLUTCH</b>	—	Passive Entry/Passive Start
<b>ENGINE MALFUNCTION SERVICE NOW</b>		Engine
<b>TRANSMISSION MALFUNCTION SERVICE NOW</b>	—	Transmission
<b>TRANSMISSION HOT STOP SAFELY</b>	—	Transmission

## Instrument Cluster

Message	Warning Lamp at Instrument Cluster	System
<b>TRANSMISSION HOT STOP OR SPEED UP</b>	—	Transmission
<b>USE BRAKE STOP SAFELY</b>	—	Transmission
<b>TRANSMISSION HOT WAIT X MIN</b>	—	Transmission
<b>TRANSMISSION HOT WAIT...</b>	—	Transmission
<b>TRANSMISSION READY</b>	—	Transmission
<b>HILL START ASSIST ACTIVE</b>	—	Transmission
<b>HILL START ASSIST OFF</b>	—	Transmission
<b>VEHICLE NOT IN PARK SELECT P</b>	—	Starting/Transmission
<b>VEHICLE NOT IN PARK SELECT P</b>	—	Starting/Transmission
<b>DOOR OPEN APPLY BRAKE</b>	—	Doors
<b>X DOOR OPEN</b>		Doors
<b>TRUNK OPEN</b>		Doors
<b>HOOD OPEN</b>		Hood
<b>AIRBAG MALFUNCTION SERVICE NOW</b>		Airbag
<b>ENGINE OIL CHANGE DUE NEXT SERVICE</b>		Engine Oil (See <i>Oil life monitoring system reset</i> later in this section)

## Instrument Cluster

Message	Warning Lamp at Instrument Cluster	System
<b>ENGINE OIL PRESSURE LOW STOP SAFELY</b>		Engine Oil
<b>BRAKE FLUID LEVEL LOW SERVICE NOW</b>	BRAKE or 	Brakes

### ***Oil life monitoring system reset***

To reset the oil service light and clear the oil change message after servicing use the following procedure:

1. Begin with the ignition off.
2. Turn the key to the accessory position for keyed vehicles and for push button start vehicles press the Start/Stop button once quickly. DO NOT attempt to start the engine.
3. Press the accelerator and brake pedals fully for 20 seconds.
4. **ENGINE OIL CHANGE DUE NEXT SERVICE** and  will display.
5. Turn the vehicle off. The message and lights will be cleared.

## Entertainment Systems

### AUDIO SYSTEMS

#### AM/FM stereo or AM/FM stereo single CD/MP3 (if equipped)

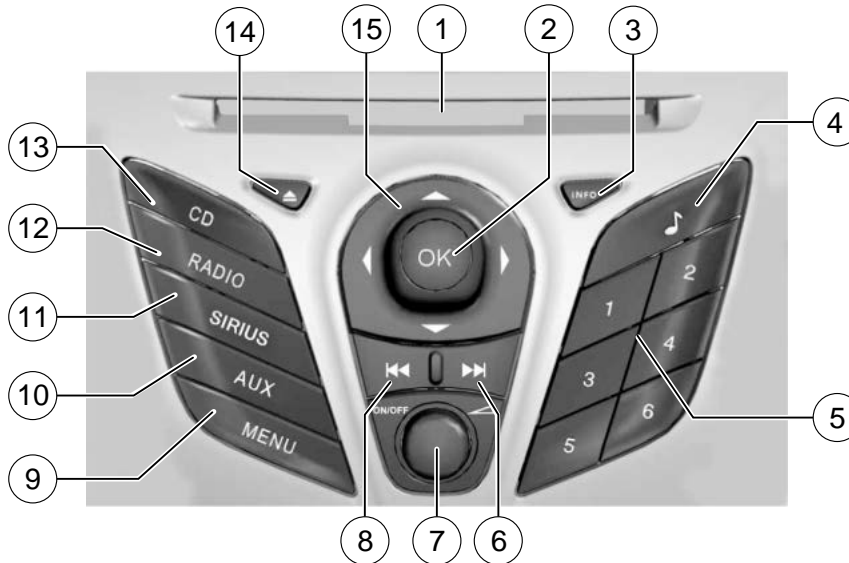

**⚠ WARNING:** Driving while distracted can result in loss of vehicle control, accident and injury. Ford strongly recommends that drivers use extreme caution when using any device or feature that may take their focus off the road. Your primary responsibility is the safe operation of the vehicle. We recommend against the use of any handheld device while driving, encourage the use of voice-operated systems when possible and that you become aware of applicable state and local laws that may affect use of electronic devices while driving.

**One hour mode:** Press the ON/OFF control to operate the system with the ignition turned off; the system will automatically turn off after one hour.

**Setting the clock:** Press the H or M buttons on the outside of the multifunction display to access the clock settings. Once you are in the clock setting, press the H or M button repeatedly until the desired number appears. Press OK to confirm and close.



## Entertainment Systems

**Display icons:** Your system's display will illuminate icons for the mode which is currently active, such as:

Stereo



Radio



CD



Auxiliary input



Settings: This icon will illuminate in red to indicate that the settings can be updated in the menu.



1. **CD slot (if equipped):** Insert a CD, label side up.
2. **OK:** Use in various menu selections to select or deselect your choice.
3. **INFO:** Press to access any available radio or CD information.
4. **Sound menu:** Press to access Treble, Bass, Middle, Fade (if equipped) and Balance menu options. Use ▲ / ▼ to cycle through the various options. When the desired option is chosen, press ◀ / ▶ to increase or decrease the levels. Press OK to set or press MENU to exit. Sound settings can be set for each audio source independently.
5. **Memory presets:** To save a station, tune to the desired station. Press and hold a preset button until sound returns.
6. **Fast forward:** Press to access the next track or available radio station. Press and hold to fast forward through the current track or to quickly advance through the radio band in individual increments.
7. **On/Off/Volume:** Press to turn the system on or off. Turn to adjust the volume.
8. **Reverse:** Press to access the previous track or available radio station. Press and hold to reverse through the current track or to quickly reverse through the radio band in individual increments.

## Entertainment Systems

9. **MENU:** Press to access the following features:

**Note:** To scroll through the following menus and make adjustments, press ▲ / ▼ or ◀ / ▶ . Press ◀ to return to the previous screen or ▶ to advance to the next screen.

**Note:** At any time, you can press MENU to close the menu screen.

- **Sirius (if equipped):** Scroll to select Sirius and then press OK to enter the menu. Scroll to select from SAT1, SAT2 or SAT3 modes.  
**Note:** Sirius must be the selected audio source for this option to appear in the menu.
- **Radio:** Scroll to select Radio mode and then move right or press OK to enter the menu. Scroll to select from:
  - **Manual Tune:** Press OK to select and press ◀ / ▶ to tune manually.
  - **Scan:** Press OK to activate scan mode for a brief sampling of stations.
  - **Autostore:** Press OK to activate the autostore feature. This allows you to store the six strongest local stations available from the AM and FM frequency bands. When the search is complete, the sound will return and the six strongest stations will be stored in the memory presets (and overwrite any stations previously stored in the AST band.) You can also manually store stations in the AST band. When the AST band is active, simply tune to the desired station and press and hold a memory preset. The new station will be saved and will override the previously saved station.
- **CD (if equipped):** Scroll to select CD options and then move right or press OK to enter the menu. Scroll to select from the following. **Note:** CD must be the selected audio source for this option to appear in the menu.
  - **Normal mode:** Scroll to select Normal Mode and press OK.
  - **Repeat:** Press OK to Repeat the current song. For MP3 discs, you can select from Repeat Title or Repeat Folder.
  - **Shuffle:** Press OK to shuffle songs. For MP3 discs, you can select from Shuffle Folder or Shuffle CD.
  - **Scan:** Press OK to activate scan mode for a brief sampling of songs. For MP3 discs, you can select from Scan Folder or Scan CD.

## Entertainment Systems

- **Audio:** Scroll to select Audio and then move right or press OK to enter the menu. Scroll to select from:
    - **SCV:** Scroll to select Speed Compensated Volume (SCV) and press OK to enter the menu. SCV automatically adjusts the system's volume to compensate for speed and wind noise. You can set the system between off and +7.
    - **Sound:** Scroll to select Sound and press OK to enter the menu. Scroll to select from Treble, Bass, Middle, Fade and Balance options. When the desired option is chosen, scroll to increase or decrease the levels. sound settings can be set for each audio source independently.
    - **Occupancy mode:** Scroll to select Occupancy mode and move right or press OK to enter. Then, scroll to select from Optimize All or Optimize Driver. Occupancy mode optimizes sound quality for the chosen seating position. Press OK to confirm your selection.
    - **DSP Equalizer:** Scroll to select DSP Equalizer and move right or press OK to enter the menu. Scroll to select from Rock, Pop, Classic, Voice and Equalizer off. Press OK to confirm your selection.
    - **RDS:** Scroll to select RDS and then move right or press OK to enter the menu. Scroll to select RDS off or RDS on. Press OK to confirm your selection.
  - **Vehicle:** Refer to Multi-function display in the *Instrument Cluster* chapter for more information.
  - **Clock:** Refer to Multi-function display in the *Instrument Cluster* chapter for more information.
  - **Display:** Refer to Multi-function display in the *Instrument Cluster* chapter for more information.
  - **Messages:** Refer to Multi-function display in the *Instrument Cluster* chapter for more information.
10. **AUX:** Press to access LINE IN (auxiliary input jack) mode.
11. **SIRIUS:** Press repeatedly to access SAT1, SAT2 and SAT3 satellite radio modes (if equipped).
12. **RADIO:** Press repeatedly to select AM1/AM2AST//FM1/FM2AST frequency bands. Press RADIO to return to the radio base screen when browsing. While listening to radio, you can navigate to other presets and modes by pressing ◀/▶. When the desired selection is chosen, press OK to tune to the selection or press RADIO to go back to current station.

## Entertainment Systems

13. **CD:** Press to enter CD mode (if equipped). While in CD mode, press ◀ / ▶ to navigate to other tracks/folders or Radio bands/stations. When your desired selection is chosen, press OK to select or press CD to return to the current track.

**Note:** If CD DRIVE HIGH TEMP appears in the display, the ambient temperature is too hot and the CD unit will not operate until it has cooled down.

While in CD mode, press INFO to display the following information (if available):

Track name



Album



Artist



File name



Information not available



14. ▲ **(Eject):** Press to eject a CD (if equipped.)

15. **Cursor controls:** Use to cycle through various menu selections.

**Note:** You can either press the arrows or move the OK knob in the desired direction.

## Entertainment Systems

AM/FM stereo single CD/MP3 SYNC® compatible (if equipped)

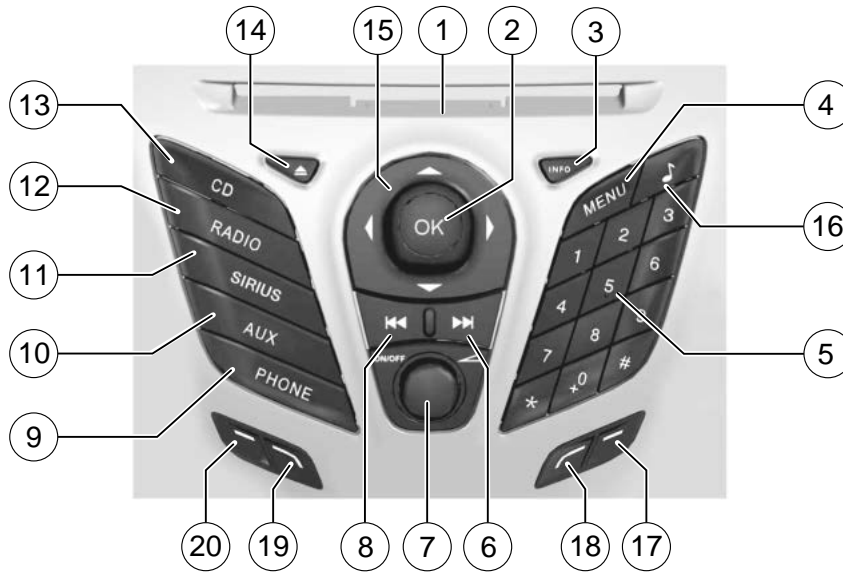

**!** **WARNING:** Driving while distracted can result in loss of vehicle control, accident and injury. Ford strongly recommends that drivers use extreme caution when using any device or feature that may take their focus off the road. Your primary responsibility is the safe operation of the vehicle. We recommend against the use of any handheld device while driving, encourage the use of voice-operated systems when possible and that you become aware of applicable state and local laws that may affect use of electronic devices while driving.

**One hour mode:** Press the ON/OFF control to operate the system with the ignition turned off; the system will automatically turn off after one hour.

**Setting the clock:** Press the H or M buttons on the outside of the multifunction to access the clock settings. Once you are in the clock setting, press the H or M button repeatedly until the desired number appears. Press OK to confirm and close.

## Entertainment Systems

**Display icons:** Your system's display will illuminate icons for the mode which is currently active, such as:

Radio



CD



Auxiliary input



Phone



Settings: This icon will illuminate in green to indicate that the settings can be updated in the menu.



1. **CD slot:** Insert a CD, label side up.
2. **OK:** Use in various menu selections to select or deselect your choice.
3. **INFO:** Press to access any available radio or CD information.
4. **MENU:** Press to access the following features:

**Note:** To scroll through the following menus and make adjustments, press ▲ / ▼ or ◀ / ▶ . Press ◀ to return to the previous screen or ▶ to advance to the next screen.

**Note:** At any time, you can press MENU to close the menu screen.

- **Sirius (if equipped):** Scroll to select Sirius and then press OK to enter the menu. Scroll to select from SAT1, SAT2 or SAT3 modes.  
**Note:** Sirius must be the selected audio source to access this menu.
- **SYNC media (if equipped):** Scroll to select Mediaplayer Menu and then press OK to enter the menu. Refer to the SYNC® section in this chapter for more information. **Note:** SYNC audio must be the selected audio source to access this menu.
- **SYNC phone (if equipped):** Scroll to select Phone Menu and then press OK to enter the menu. Refer to the SYNC® section in this chapter for more information. **Note:** SYNC Phone must be the selected feature to access this menu.

## Entertainment Systems

- **Audio:** Scroll to select Audio and then move right or press OK to enter the menu. Scroll to select from:
    - **SCV:** Scroll to select Speed Compensated Volume (SCV) and press OK to enter the menu. SCV automatically adjusts the system's volume to compensate for speed and wind noise. You can set the system between off and +7.
    - **Sound:** Scroll to select Sound and move right or press OK to enter the menu. Scroll to select from Treble, Bass, Middle, Fade and Balance options. When the desired option is chosen, scroll to increase or decrease the levels. Sound settings can be set for each audio source independently.
    - **Occupancy mode:** Select Occupancy mode and then move right or press OK to enter the menu. Scroll to select from optimize All Seats or Driver's Seat. Occupancy mode optimizes sound quality for the chosen seating position. Press OK to confirm your selection.
    - **DSP Equalizer:** Scroll to select DSP Equalizer and then move right or press OK to enter the menu. Scroll to select from Rock, Pop, Classic, Voice and Equalizer off. Press OK to confirm your selection.
  - **Vehicle:** Refer to Multi-function display in the *Instrument Cluster* chapter for more information.
  - **Clock:** Refer to Multi-function display in the *Instrument Cluster* chapter for more information.
  - **Display:** Refer to Multi-function display in the *Instrument Cluster* chapter for more information.
  - **Messages:** Press ▲ / ▼ to view the saved vehicle messages.
  - **RDS:** Scroll to select RDS and then move right or press OK to enter the menu. Scroll to select RDS off or RDS on. Press OK to confirm your selection.
5. **Memory presets:** To save a station, tune to the desired station. Press and hold a preset button until the information pop-up timer expires and stored preset # pop-up appears.
6. **▶▶ Fast forward:** Press to access the next track or available radio station. Press and hold to fast forward through the current track or to quickly advance through the radio band in individual increments.
7. **On/Off/Volume:** Press to turn the system on or off. Turn to adjust the volume.

## Entertainment Systems

8. **◀◀ Reverse:** Press to access the previous track or available radio station. Press and hold to reverse through the current track or to quickly reverse through the radio band in individual increments.
9. **PHONE:** Press to access SYNC® phone features if available. Refer to the SYNC® section for more information. If your vehicle is not equipped with SYNC®, the display will read MUTE and will mute the playing media.
10. **AUX:** Press to access LINE IN (auxiliary input jack) mode or SYNC® media mode.
11. **SIRIUS:** Press repeatedly to access SAT1, SAT2 and SAT3 satellite radio modes (if equipped).
12. **RADIO:** Press repeatedly to select AM1/AM2AST/FM1/FM2AST frequency bands. Press RADIO to return to the radio base screen when browsing. While listening to radio, you can also navigate to other preset modes, CD tracks and folders by pressing ◀/▶. When the desired selection is chosen, press OK to tune to the selection or press RADIO to return to the current station. You can also select SIRIUS (if equipped) or AUX to change to the audio source.  
**Autostore feature:** The autostore feature allows you to store the 10 strongest local stations available from the AM and FM frequency bands. To use, press the AST soft key at the bottom of the screen (refer to buttons 17–20). The display will read 'Hold to start autostore'. Continue holding the button until 'Autostoring' appears in the display. When the search is complete, the sound will return and the 10 strongest stations will be stored in the memory presets (and overwrite any stations previously stored in the AST band). You can also manually store stations in the AST band. When the AST band is active, simply tune to the desired station and press and hold a memory preset. The new station will be saved and will override the previously saved station.
13. **CD:** Press to enter CD mode. Press the soft keys (refer to buttons 17–20) to scan, repeat or shuffle. In MP3 mode, you can scan folder or CD, repeat track or folder and shuffle folder or CD. While in CD mode, press ◀/▶ to navigate to other tracks/folders or radio modes/stations. When the desired selection is chosen, press OK to select or press CD to return to the current track. You can also select SIRIUS (if equipped), or AUX to change audio sources.  
**Note:** If CD DRIVE HIGH TEMP appears in the display, the ambient temperature is too hot and the CD unit will not operate until it has cooled down.



## Entertainment Systems

14. **▲ (Eject):** Press to eject a CD.

15. **Cursor controls:** Use to cycle through various menu selections.  
**Note:** You can either press the arrows or move the OK knob in the desired direction.

16. **Sound menu:** Press access Treble, Bass, Fade (if equipped) and Balance menu options. Use ▲ / ▼ to cycle through the various options. When the desired option is chosen, press ◀ / ▶ to increase or decrease the levels. Press OK to set or MENU to exit. Sound settings can be set for each audio source independently.

17–20 **Soft keys:** Press these soft keys to access the corresponding functions on the screen.

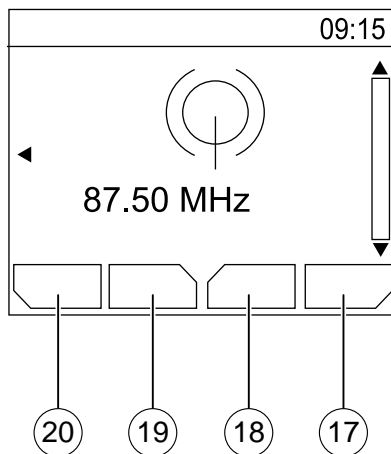

### Auxiliary input jack (Line in)



**WARNING:** Driving while distracted can result in loss of vehicle control, accident and injury. Ford strongly recommends that drivers use extreme caution when using any device or feature that may take their focus off the road. Your primary responsibility is the safe operation of the vehicle. We recommend against the use of any handheld device while driving, encourage the use of voice-operated systems when possible and that you become aware of applicable state and local laws that may affect use of electronic devices while driving.

## Entertainment Systems

The auxiliary input jack (AIJ) provides a way to connect your portable music player to the in-vehicle audio system. This allows the audio from a portable music player to be played through the vehicle speakers with high fidelity. To achieve optimal performance, please observe the following instructions when attaching your portable music device to the audio system.

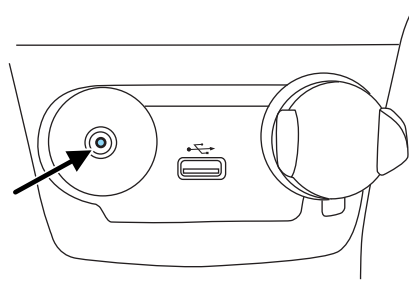

### Required equipment:

1. Any portable music player designed to be used with headphones
2. An audio extension cable with stereo male 1/8 in. (3.5 mm) connectors at each end

### To play your portable music player using the auxiliary input jack:

1. Begin with the vehicle parked and the radio turned off.
2. Ensure that the battery in your portable music player is new or fully charged and that the device is turned off.
3. Attach one end of the audio extension cable to the headphone output of your player and the other end of the audio extension cable to the AIJ in your vehicle.
4. Turn the radio on, using either a tuned FM station or a CD loaded into the system. Adjust the volume to a comfortable listening level.
5. Turn the portable music player on and adjust the volume to 1/2 the volume.
6. Press AUX on the vehicle radio repeatedly until LINE, LINE IN or SYNC LINE IN appears in the display. You should hear audio from your portable music player although it may be low.
7. Adjust the sound on your portable music player until it reaches the level of the FM station or CD by switching back and forth between the AUX and FM or CD controls.



**WARNING:** For safety reasons, do not connect or adjust the settings on your portable music player while the vehicle is moving.

## Entertainment Systems

 **WARNING:** Store the portable music player in a secure location, such as the center console or the glove box, when the vehicle is in motion. Hard objects may become projectiles in a collision or sudden stop, which may increase the risk of serious injury. The audio extension cable must be long enough to allow the portable music player to be safely stored while the vehicle is in motion.

### USB port (if equipped)

 **WARNING:** Driving while distracted can result in loss of vehicle control, accident and injury. Ford strongly recommends that drivers use extreme caution when using any device or feature that may take their focus off the road. Your primary responsibility is the safe operation of the vehicle. We recommend against the use of any handheld device while driving, encourage the use of voice-operated systems when possible and that you become aware of applicable state and local laws that may affect the use of electronic devices while driving.

Your vehicle may be equipped with a USB port. This feature allows you to plug in media playing devices, memory sticks, and also to charge devices if they support this feature. For further information on this feature, refer to the *SYNC*<sup>®</sup> supplement.

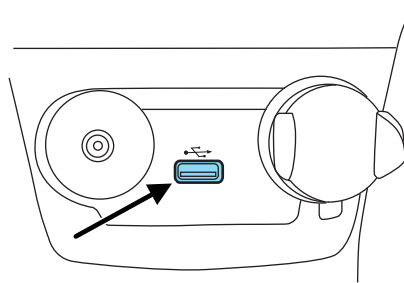

## Entertainment Systems

### GENERAL AUDIO INFORMATION

#### Radio frequencies:

AM and FM frequencies are established by the Federal Communications Commission (FCC) and the Canadian Radio and Telecommunications Commission (CRTC). Those frequencies are:

AM: 530, 540–1700, 1710 kHz

FM: 87.9–107.7, 107.9 MHz

#### Radio reception factors:

There are three factors that can affect radio reception:

- Distance/strength: The further you travel from an FM station, the weaker the signal and the weaker the reception.
- Terrain: Hills, mountains, tall buildings, power lines, electric fences, traffic lights and thunderstorms can interfere with your reception.
- Station overload: When you pass a broadcast tower, a stronger signal may overtake a weaker one and play while the weak station frequency is displayed.

#### CD/CD player care

Do:

- Handle discs by their edges only. (Never touch the playing surface).
- Inspect discs before playing.
- Clean only with an approved CD cleaner.
- Wipe discs from the center out.

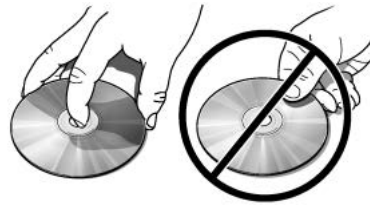

Don't:

- Expose discs to direct sunlight or heat sources for extended periods of time.
- Clean using a circular motion.

## Entertainment Systems

CD units are designed to play commercially pressed 4.75 in (12 cm) audio compact discs only. Due to technical incompatibility, certain recordable and re-recordable compact discs may not function correctly when used in Ford CD players.

Do not use any irregular shaped CDs or discs with a scratch protection film attached.

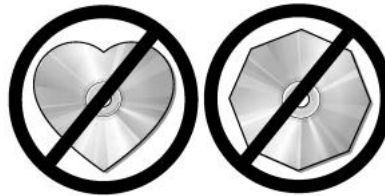

CDs with homemade paper (adhesive) labels should not be inserted into the CD player as the label may peel and cause the CD to become jammed. It is recommended that homemade CDs be identified with permanent felt tip marker rather than adhesive labels. Ballpoint pens may damage CDs. Please contact your authorized dealer for further information.



### Audio system warranty and service

Refer to the *Warranty Guide* for audio system warranty information. If service is necessary, see your dealer or qualified technician.

### MP3 track and folder structure

Your MP3 system recognizes MP3 individual tracks and folder structure as follows:

- There are two different modes for MP3 disc playback: MP3 track mode (system default) and MP3 folder mode. For more information on track and folder mode, refer to *Sample MP3 structure* in the following section.
- MP3 track mode ignores any folder structure on the MP3 disc. The player numbers each MP3 track on the disc (noted by the .mp3 file extension) from T001 to a maximum of T255.  
**Note:** The maximum number of playable MP3 files may be less depending on the structure of the CD and exact model of radio present.

## Entertainment Systems

- MP3 folder mode represents a folder structure consisting of one level of folders. The CD player numbers all MP3 tracks on the disc (noted by the .mp3 file extension) and all folders containing MP3 files, from F001 (folder) T001 (track) to F253 T255.
- Creating discs with only one level of folders will help with navigation through the disc files.

### Sample MP3 structure

If you are burning your own MP3 discs, it is important to understand how the system will read the structures you create. While various files may be present, (files with extensions other than mp3), only files with the .mp3 extension will be played. Other files will be ignored by the system. This enables you to use the same MP3 disc for a variety of tasks on your work computer, home computer and your in-vehicle system.

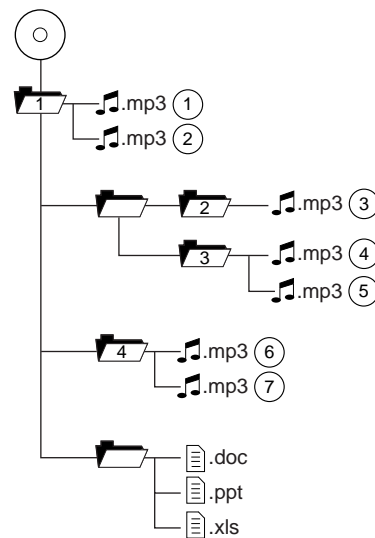

In track mode, the system will display and play the structure as if it were only one level deep (all .mp3 files will be played, regardless of being in a specific folder). In folder mode, the system will only play the .mp3 files in the current folder.

## Entertainment Systems

### Satellite radio information (if equipped)

**Satellite radio channels:** SIRIUS® broadcasts a variety of music, news, sports, weather, traffic and entertainment satellite radio channels. For more information and a complete list of SIRIUS® satellite radio channels, visit [www.sirius.com](http://www.sirius.com) in the United States, [www.siriuscanada.ca](http://www.siriuscanada.ca) in Canada, or call SIRIUS® at 1-888-539-7474.

**Satellite radio reception factors:** To receive the satellite signal, your vehicle has been equipped with a satellite radio antenna located on the roof of your vehicle. The vehicle roof provides the best location for an unobstructed, open view of the sky, a requirement of a satellite radio system. Like AM/FM, there are several factors that can affect satellite radio reception performance:

- **Antenna obstructions:** For optimal reception performance, keep the antenna clear of snow and ice build-up and keep luggage and other material as far away from the antenna as possible.
- **Terrain:** Hills, mountains, tall buildings, bridges, tunnels, freeway overpasses, parking garages, dense tree foliage and thunderstorms can interfere with your reception.
- **Station overload:** When you pass a ground based broadcast repeating tower, a stronger signal may overtake a weaker one and result in an audio mute.

Unlike AM/FM audible static, you will hear an audio mute when there is a satellite radio signal interference. Your radio display may display NO SIGNAL to indicate the interference.

**SIRIUS® satellite radio service:** SIRIUS® Satellite Radio is a subscription based satellite radio service that broadcasts music, sports, news and entertainment programming. A service fee is required in order to receive SIRIUS® service. Vehicles that are equipped with a factory installed SIRIUS® Satellite Radio system include:

- Hardware and limited subscription term, which begins on the date of sale or lease of the vehicle.

For information on extended subscription terms, the online media player and other SIRIUS® features, please contact SIRIUS® at 1-888-539-7474.

**Note:** SIRIUS® reserves the unrestricted right to change, rearrange, add or delete programming including canceling, moving or adding particular channels, and its prices, at any time, with or without notice to you. Ford Motor Company shall not be responsible for any such programming changes.

## Entertainment Systems

**Satellite Radio Electronic Serial Number (ESN):** This 12-digit Satellite Serial Number is needed to activate, modify or track your satellite radio account. You will need this number when communicating with SIRIUS. While in Satellite Radio mode, you can view this number on the radio display by pressing the SIRIUS and Preset 1 buttons at the same time.

Radio Display	Condition	Action Required
ACQUIRING	Radio requires more than two seconds to produce audio for the selected channel.	No action required. This message should disappear shortly.
SAT FAULT	Internal module or system failure present.	If this message does not clear within a short period of time, or with an ignition key cycle, your receiver may have a fault. See your authorized dealer for service.
INVALID CHNL	Channel no longer available.	This previously available channel is no longer available. Tune to another channel. If the channel was one of your presets, you may choose another channel for that preset button.
UNSUBSCRIBED	Subscription not available for this channel.	Contact SIRIUS® at 1-888-539-7474 to subscribe to the channel or tune to another channel.



## Entertainment Systems

Radio Display	Condition	Action Required
NO TEXT	Artist information not available.	Artist information not available at this time on this channel. The system is working properly.
NO TEXT	Song title information not available.	Song title information not available at this time on this channel. The system is working properly.
NO TEXT	Category information not available.	Category information not available at this time on this channel. The system is working properly.
NO SIGNAL	Loss of signal from the SIRIUS® satellite or SIRIUS® tower to the vehicle antenna.	You are in a location that is blocking the SIRIUS® signal (i.e., tunnel, under an overpass, dense foliage, etc.). The system is working properly. When you move into an open area, the signal should return.
UPDATING	Update of channel programming in progress.	No action required. The process may take up to three minutes.
CALL SIRIUS 1-888-539-7474	Satellite service has been deactivated by SIRIUS® Satellite Radio.	Call SIRIUS® at 1-888-539-7474 to re-activate or resolve subscription issues.

## Entertainment Systems

### SYNC® (IF EQUIPPED)

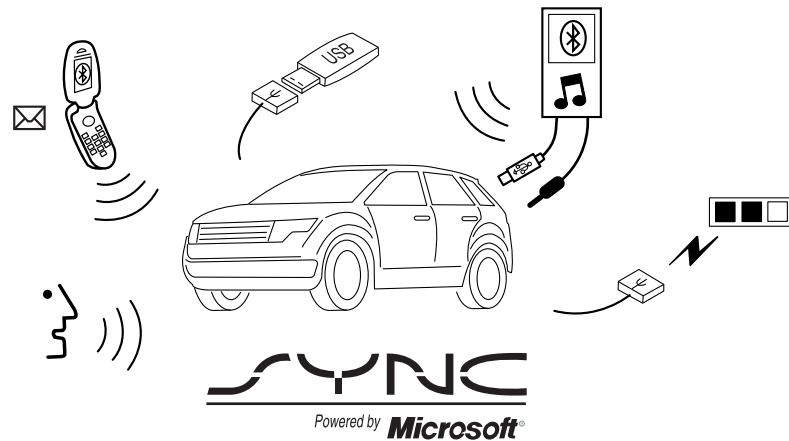

Ford ingenuity brings you SYNC® – an in-car connectivity system designed with convenience in mind.

SYNC literally ‘syncs up’ with your *Bluetooth*® enabled cellular phone and portable media player, creating a comprehensive and easy-to-use system offering features such as:

- Making and receiving calls on your *Bluetooth*® cellular phone
- Accessing and playing music from your portable music player
- 911 Assist™, Vehicle Health Reports, Traffic, Directions & Information, (if equipped)
- Using applications such as Pandora and Stitcher via SYNC® AppLink™, (if equipped)
- Accessing phonebook contacts and music via voice commands
- Streaming music from your *Bluetooth* enabled cellular phone
- Text messaging
- Advanced voice recognition fluent in English, French and Spanish
- USB device charging (if your device supports this)

Welcome to technology that is both fun and functional, welcome to SYNC®.

## Entertainment Systems

### Added benefits

SYNC® even has some benefits which extend beyond your car. You can:

- Access on-line support
- Chat with other SYNC® owners
- Search for and download new applications
- Check frequently asked questions (FAQs)
- Check your phone and other devices' compatibility
- Register and set up your account to use features such as Vehicle Health Report and Traffic, Directions and Information.

Visit [www.SyncMyRide.com](http://www.SyncMyRide.com) or [www.syncmaroute.ca](http://www.syncmaroute.ca) today to access these added benefits.

### Support

In addition to the web site and the material in this publication, you may also find the following helpful:

**The Troubleshooting section** later in this chapter contains common troubleshooting questions and answers on specific issues as well as some helpful hints .

**The SYNC support team** is also there if you feel like you need additional support, or if you just prefer to speak with a live person. Our team will do their best to help you with any questions you are not able to answer on your own.

**Hours:** Monday-Saturday, 8:30 am-8pm EST

- In the United States, call: 1-888-270-1055
- In Canada, call: 1-800-565-3673

**Note:** Times are subject to change due to holidays.

### Driving restrictions

For your safety and in order to prevent any distractions while driving, certain features are restricted when your vehicle is traveling over 3 mph (5km/h). These features will be noted as *speed dependent* when they are discussed in this supplement.

## Entertainment Systems

### Safety information



**WARNING:** Driving while distracted can result in loss of vehicle control, accident and injury. Ford strongly recommends that drivers use extreme caution when using any device that may take their focus off the road. Your primary responsibility is the safe operation of the vehicle. We recommend against the use of any handheld device while driving, encourage the use of voice-operated systems when possible and that you become aware of applicable state and local laws that may affect use of electronic devices while driving.

- Do not attempt to service or repair SYNC®. See your authorized dealer.
- Do not operate playing devices if the power cords and/or cables are broken, split or damaged. Carefully place cords and/or cables where they will not be stepped on or interfere with the operation of pedals, seats and/or compartments, or safe driving abilities.
- Do not leave playing devices in the vehicle in extreme conditions as it could cause damage to your device. Refer to your device's user guide for further information.
- Ensure that you review your device's user guide before using with SYNC®.

### Privacy information

When a cellular phone is connected to SYNC®, SYNC® creates a profile within your vehicle that is linked to that cellular phone. This profile is created in order to offer you more cellular features and to operate more efficiently. Among other things, this profile may contain data about your cellular phone book, text messages (read and unread), and call history, including history of calls when your cell phone was not connected to SYNC®. In addition, if you connect a media device, SYNC® creates and retains an index of media content supported by SYNC®. SYNC® also records a short development log of approximately 10 minutes of all recent SYNC® activity. The log profile and other SYNC® data may be used to improve SYNC® and help diagnose any problems that may occur.

The cellular profile, media device index, and development log will remain in the vehicle unless you delete it and are generally accessible only in the vehicle when the cellular phone or media player is connected. If you no longer plan to use SYNC® or the vehicle, we recommend you perform a Master Reset to erase all information stored in SYNC®.

SYNC® data cannot be accessed without special equipment and access to the vehicle's SYNC® module. Ford Motor Company and Ford of Canada will not access SYNC® data for any purpose other than as described absent

## Entertainment Systems

consent, a court order, or where required by law enforcement, other government authorities, or other third parties acting with lawful authority. Other parties may seek to access the information independently of Ford Motor Company and Ford of Canada. For further privacy information, see the sections on 911 Assist™ (if equipped), Vehicle Health Report (if equipped), and Traffic, Directions and Information (if equipped).

### Using your voice recognition system

Your SYNC® system comes equipped with an advanced voice recognition (VR) system. This system is easy to use and helps you control many features via voice commands, thereby allowing you to keep your hands on the wheel and focus on what is in front of you.

Here we'll cover the basics of how the system works and some global voice commands. The majority of the voice commands will be covered later in the supplement with their respective modes (phone, media, etc.) and will also be indicated with the voice icon shown below.



### Initiating a voice session

To initiate a voice session with your SYNC system:

1. Press .
2. Wait until you hear a tone prompt and Listening appears in the display.
3. Say any of the following global commands:
  - “Phone”: Say to make calls.
  - “USB”: Say to access the device connected to your USB port.
  - “Bluetooth Audio”: Say to stream audio from your phone.
  - “Line in” : Say to access the device connected to the auxiliary input jack.
  - “Cancel”: Say to cancel the requested action.
  - “SYNC”: Say to return to the main menu.
  - “Voice settings”: Say to adjust the level of voice interaction and feedback.
  - “Help”: Say for an audible list of voice commands available in the current mode.
  - “Vehicle Health Report” (if equipped, U.S. only): Say to run a health report.

## Entertainment Systems

- “Services” (if equipped, U.S. only): Say to access the SYNC Services portal.
- “Mobile Apps” (if equipped, U.S. only) : Say to access Mobile Applications (if available).

### System interaction and feedback

The system provides feedback through audible tones, prompts, questions and spoken confirmations depending on the situation and the chosen level of interaction (voice settings). You can customize your VR system to provide more or less instruction and feedback.

The default setting is to a higher level of interaction in order to be of more help when you are first using the system. You can change these settings at any time.



### Adjusting the interaction level

1. Press  and when prompted, say, “Voice settings”.
2. You can say any of the following commands:
  - “Interaction mode standard” / “Interaction mode advanced”  
*Standard* interaction provides more detailed interaction and guidance while *advanced* has less audible interaction and more tone prompts. The system defaults to the standard setting.
  - “Confirmation prompts on” / “Confirmation prompts off”  
*Confirmation prompts* are short questions the system asks when it is not sure of your request or when there are multiple possible responses to your request. (For example, the system may ask, “Phone, is that correct?”) If turned off, the system will simply make a best guess as to what you requested and you may still occasionally be asked to confirm settings.
  - “Phone candidate lists on” / “Phone candidate lists off”
  - “Media candidate lists on” / “Media candidate lists off”  
The system creates *candidate lists* when it has the same confidence level of several options based on your voice command. When turned on, the system may submit back as many as four possibilities for clarification.

## Entertainment Systems

For example, “Say 1 after the tone to call John Doe at home. Say 2 after the tone to call Johnny Doe on mobile. Say 3 after the tone to call Jane Doe at home.” Or, “Say 1 after the tone to play John Doe, Say 2 after the tone to play Johnny Doe.

### **Helpful Hints**

- Ensure that the interior of the vehicle is as quiet as possible. Wind noise from open windows and road vibrations may prevent the system from correctly recognizing spoken commands.
- After pressing  , ensure that you wait until after the tone sounds and Listening appears in the display before saying a command. Any command spoken prior to this will not register with the system.
- Speak naturally without long pauses between words.
- At any time you can interrupt the system while it is speaking by pressing .

### **Using SYNC®'s phone features**

One of the main features of SYNC is hands-free calling which works in conjunction with your *Bluetooth* enabled cellular phone. In this section, we'll cover your phone features in menu mode, applicable voice commands and also any additional options you may have.

### **Phone dependent features**

While SYNC® supports a variety of features, many are dependent upon the functionality of your cell phone with *Bluetooth*® wireless technology. At a minimum, most cellular phones with *Bluetooth* wireless technology support the following functions:

- Answering an incoming call
- Ending a call
- Using privacy mode
- Dial a number
- Redial
- Call waiting notification
- Caller ID

Other features, such as text messaging via *Bluetooth*, and automatic phone book download are phone dependent features. To ensure that you have a compatible cellular phone, refer to your phone's user manual and visit [www.SyncMyRide.com](http://www.SyncMyRide.com) or [www.syncmaroute.ca](http://www.syncmaroute.ca).

## Entertainment Systems

### Pairing a phone for the first time

The first thing you must do to use a phone with the system is to wirelessly pair your phone with SYNC. Doing so allows your phone to communicate with the hands-free system, thereby enabling you to make and receive hands-free calls.

**Note:** To scroll through the menus, press ▲ / ▼ .

1. Ensure that the vehicle ignition and radio are turned on and that you are in P (Park).
2. Press PHONE or  . When the display indicates no phone is paired press OK.
3. When Add Bluetooth Device appears, press OK.
4. When Find SYNC appears in the display, press OK.
5. Put your phone into *Bluetooth* discovery mode. Refer to your phone's user guide if necessary.
6. When prompted on your phone's display, enter the six digit PIN provided by SYNC in the radio display.
7. The display will indicate when the pairing is successful.
8. Depending on your phone's capability and your market, the system may prompt you with questions such as setting the current phone as the primary phone (the phone SYNC will automatically try to connect with first upon vehicle start-up), downloading your phone book, turning on 911 Assist™ (if available), etc.

**Note:** SYNC® can support downloading up to approximately 2,000 entries per *Bluetooth* enabled cellular phone.

**Note:** If one phone has already been paired to SYNC, the process to pair another is slightly different. To pair subsequent phones, please refer to *Pairing subsequent phones* in the following section.



## Entertainment Systems

### ***Pairing subsequent phones***

Once you have a phone paired with the system, the steps to pair another phone is a bit different. To pair a subsequent phone:

**Note:** To scroll through the menus, press ▲ / ▼ .

1. Ensure that the vehicle ignition and radio are turned on and that you are in P (Park).
2. Press PHONE or  and scroll until System Settings is selected.
3. Press OK and scroll until Bluetooth Devices is selected and press OK.
4. Scroll until Add Bluetooth Device is selected and press OK.
5. When Find SYNC appears in the display, press OK.
6. Put your phone into *Bluetooth* discovery mode. Refer to your phone's user guide if necessary.
7. When prompted on your phone's display, enter the six digit PIN provided by SYNC in the radio display.
8. The display will indicate when the pairing is successful.
9. The system will then prompt with questions such as if you would like to set the current phone as the primary phone (the phone SYNC will automatically try to connect with first upon vehicle start-up), download your phone book, turn on 911 Assist™ (if available), etc.

## Entertainment Systems



### Phone voice commands

Press and when prompted, say, “Phone”. You may then say any of the following:

- |  |   |
|--|---|
| • Call <name> <sup>2</sup>                         | • Call <name> at home <sup>2</sup>                                      |
| • Call <name> on mobile OR cell <sup>2</sup>       | • Call <name> at work OR Call <name> in office <sup>2</sup>             |
| • Call <name> on other <sup>2</sup>                | • Dial* <sup>2</sup>  |
| • Phone book <name> at home <sup>1</sup>           | • Phone book <name> <sup>1</sup>  |
| • Phone book <name> on mobile OR cell <sup>1</sup> | • Phone book <name> at work OR Phone book <name> at office <sup>1</sup> |
| • Call history outgoing <sup>1</sup>               | • Call history incoming <sup>1</sup>                                    |
| • Phone book <name> on Other <sup>1</sup>          | • Connections <sup>1</sup>  |
| • Call history missed <sup>1</sup>                 | • Go to privacy   |
| • Menu** <sup>1</sup>                              | • Hold  |
| • Join   |   |

<sup>1</sup> Voice commands are not available until downloading phone information via *Bluetooth* is complete.

<sup>2</sup> Voice commands which are available at the first level (without having to say, “Phone”).

**Phone book commands:** When you ask SYNC® to access a phone book name, number, etc., the requested information will appear in the display to view. Press or PHONE or say “Call” to call the contact.

**\* If you have said, “Dial” you can say any of the following commands:**

- |  |                                      |
|--|--------------------------------------|
| • <number> 0–9                                 | • Dial                               |
| • Delete (deletes one digit)                   | • Clear (deletes all entered digits) |
| • Plus   | • Star                               |
| • Asterisk (*)                                 | • 800 (eight hundred)                |
| • 700 (seven hundred)                          | • 900 (nine hundred)                 |
| • 411 (four-one-one), 911 (nine-one-one), etc. | • # / (pound, slash)                 |

**Helpful hint:** To exit dial mode, press and hold or PHONE or press MENU to go to the PHONE MENU.

## Entertainment Systems

**\*\* If you have said, “Menu”, you can then say any of the following commands:**

- |  |   |
|--|---|
| • [Phone] settings [message] notification on | • [Phone] settings [message] notification off |
| • [Phone] connections                        | • Phone name                                  |
| • Signal                                     | • Battery                                     |
| • [Phone] settings [set] phone ringer        | • [Phone] settings [set] ringer 1             |
| • [Phone] settings [set] ringer 2            | • [Phone] settings [set] ringer 3             |
| • Text message inbox                         | • [Phone] settings [set] ringer off           |

**Note:** With the above commands, words in [ ] are optional and do not have to be spoken for the system to understand the command.



**At any time, you can say the following global commands:**

- |                                     |  |
|-------------------------------------|--|
| • SYNC                              | • USB  |
| • Line in                           | • Bluetooth Audio                                |
| • Phone                             | • Voice settings                                 |
| • Cancel                            | • Vehicle Health Report (if equipped, U.S. only) |
| • Services (if equipped, U.S. only) | • Mobile Apps (if equipped, U.S. only)           |
| • Help                              |  |

### Making a call

To make a call, press  and when prompted say:

- “Call <name>” or
- “Dial” and the desired number. When the system confirms the number, say “Dial” again to initiate the call.

**Note:** To erase the last spoken digit, say “Delete” or press . To erase all spoken digits, say “Clear” or press and hold .

### To end a call:



- Select ‘End’ on-screen using the system’s soft keys beneath the audio system
- Press and hold PHONE on the audio system
- Press and hold  on the steering wheel controls

<https://www.MyCarManual.com>

## Entertainment Systems

### **Answering an incoming call**

During an incoming call, you will hear an audible ring. You can then:

- Answer the call by pressing  or PHONE.
- Reject the call by pressing and holding  or PHONE.
- Ignore the call by doing nothing.

### **Phone options during an active call**

During an active call, you have additional menu features which become available such as putting a call on hold, joining calls, etc.

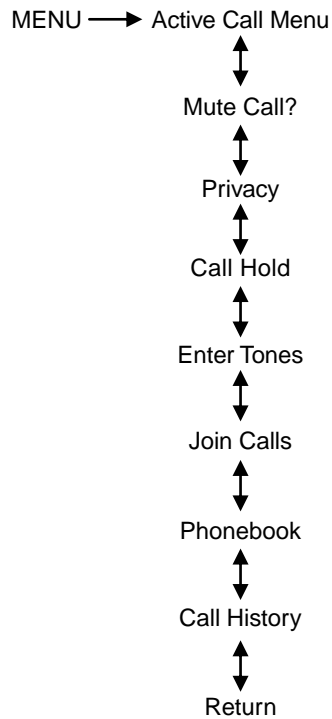

## Entertainment Systems

**Scrolling through the menus:** Use ▲ / ▼ to scroll through the menu options.

To access:

1. Press MENU during an active call.
2. When Active Call Menu is selected, press OK.
3. Scroll to cycle through the following options:

**Mute Call?:** Enables you to mute the current call so that you can have a private conversation in the vehicle cabin. The display will indicate the call is muted.

**Privacy:** Enables you to switch a call from an active hands-free environment back to your cellular phone for a more private conversation.

- Press OK to select and press OK again when Privacy on/off appears. The display will indicate In Privacy and the system will transfer your call.

**Call Hold:** Allows you to put an active call on hold to have a private conversation within the vehicle cabin or to answer another call.

1. Press OK to select and press OK again when Hold on/off appears.
2. To answer another call at this time, press ☎ or PHONE.

**Enter Tones:** Allows you to enter 'tones' such as numbers for passwords.

1. Press OK to select and then scroll until the desired number appears in the display and press OK.
2. A tone will sound as confirmation. Repeat as necessary.

## Entertainment Systems

**Join Calls:** Allows you to join two separate calls and speak to both through SYNC.

1. Press  or PHONE to put your first call on hold.
2. Access the desired contact through SYNC or use voice commands to place the second call. Once actively in the second call, press MENU.
3. Scroll until Join Calls appears and press OK. Press OK again when Join Calls? appears to confirm.
4. The system will join the calls, allowing you to speak to both parties at the same time. SYNC can support a maximum of three callers on a multiparty/conference call.

**Phonebook:** Allows you to access your phonebook contacts.

1. Press OK to select and scroll to cycle through your phonebook contacts.
2. Press OK when the desired selection appears in the display.
3. Press  or PHONE to call the selection.

**Call History:** Allows you to access your call history log.

1. Press OK to select and scroll to cycle through your call history options (incoming, outgoing or missed).
2. Press OK when the desired selection appears in the display.
3. Press  or PHONE to call the selection.

**Return:** Press OK to exit the current menu.

## Entertainment Systems

### Maneuvering the phone menu

Below is a graphical representation of how the phone menu lays out in your system. It will be explained in more detail in this chapter, but this may help you to better visualize the menu structure.

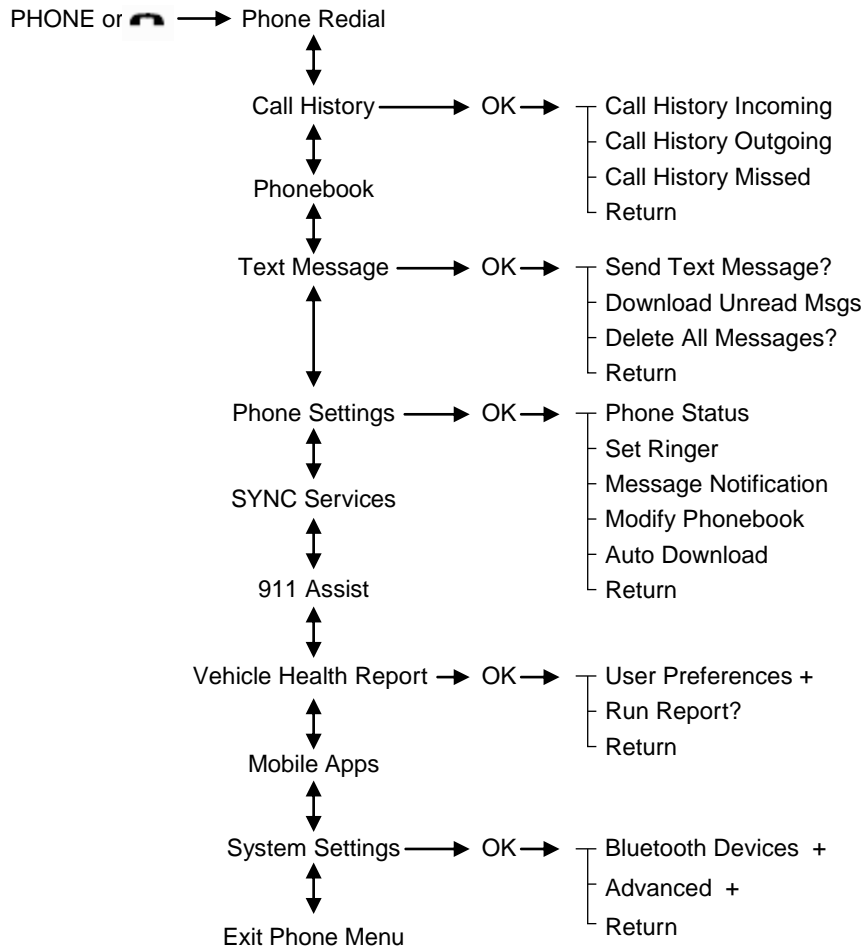

+ Denotes submenus with additional menu items

## Entertainment Systems

**Scrolling through the menus:** Press ▲ / ▼ on your audio system to scroll through the menu options.

### **Accessing features through the phone menu**

SYNC's phone menu allows you to redial a number, access your call history and phone book and send text messages as well as accessing phone and system settings. You can also access advanced features such as 911 Assist™, Vehicle Health Report and SYNC Services.



To access your phone menu:

1. Press PHONE or  to enter the Phone Menu.
2. Scroll to cycle through the following features:

**Phone Redial:** Redials the last number called (if available).



- Press OK to select and press OK again to confirm. The display will indicate *Redialing...* as it is placing the call.

**Call History: This is a phone dependent feature** which allows you to access any previously dialed, received or missed calls while your phone has been connected to SYNC.

-  1. Press OK to select.
2. Scroll to select from Call History Incoming, Call History Outgoing or Call History Missed. Press OK to enter the chosen menu and scroll to cycle through your calls.
3. Press OK, PHONE or  to call the desired selection.

**Note:** SYNC will attempt to automatically re-download your phone book / call history each time your phone connects to SYNC (if the auto download feature is on and your *Bluetooth* enabled cellular phone supports this feature).

**Phonebook: This is a phone and speed dependent feature** which allows you to access your downloaded phonebook.

-  1. Press OK to confirm and enter. **Note:** If your phonebook has less than 255 listings, they will appear alphabetically in flat file mode. If there are more, they will be organized into alphabetical categories.
2. Scroll until the desired contact appears and press OK.
3. Press OK or PHONE or  to call the contact.

**Note:** SYNC can support downloading up to approximately 2,000 entries per *Bluetooth* enabled cellular phone .



## Entertainment Systems

**Text Message:** This is a phone dependent feature which enables you to send, download and delete text messages.

- Please refer to *Text Messaging* in the following section for complete information.

**Phone Settings:** These are phone dependent features which allow you to view your phone's status, set a ring tone, select your message notification, change phone book entries and also to automatically download your cellular phone among other features.

- Please refer to *Phone Settings* in the following section for complete information.

**SYNC Services** (if equipped, U.S. only): Select to access the SYNC services portal where you can request various types of information, traffic reports and directions.

- Refer to *SYNC Services* later in this chapter.

**911 Assist** (if equipped): When used properly, this can place an emergency call to a 911 operator for you after an accident.

- Refer to *911 Assist* later in this chapter.

**Vehicle Health Report** (if equipped, U.S. only): Enables you to run and receive a diagnostic report card on your vehicle.

- Refer to *Vehicle Health Report* later in this chapter.

**Mobile Apps** (if equipped, U.S. only): Enables you to interact with SYNC® capable mobile applications on your smartphone. Refer to SYNC® AppLink™ section later in this chapter.

**System Settings:** Press OK to access Bluetooth Devices menu listings (add, connect, set as primary, on/off, delete) as well as Advanced menu listings (prompts, languages, defaults, master reset, install application and system information).

- Refer to Bluetooth Devices menu and Advanced menu options in the following sections for more information.

**Exit Phone Menu:** Press OK when this appears in the display to exit the phone menu.

## Entertainment Systems

### Text messaging

SYNC allows you to receive, send, download and delete text messages. The system will even read incoming text messages to you so that you do not have to take your eyes off the road.

**Note:** This is a phone dependent feature.

#### **Receiving a text message**

**Note:** This is a phone dependent feature. Your phone must support downloading text messages via *Bluetooth* to receive incoming text messages.

When a new message arrives:

1. An audible tone will sound and the display will indicate you have a new message.
2. Press  , wait for the prompt and say, “Read Message” to have SYNC read the message to you.
3. Press OK to receive and open the text message or do nothing and the message will go into your text message inbox. Press OK again and SYNC® will read your message aloud as you are not able to view the message. You can then also choose whether you'd like to reply or forward the message.
4. Press OK and scroll to choose between:
  - Reply to Text Message: Press OK to access and then scroll through the list of predefined messages to send.
  - Forward Text Message: Press OK to forward the message to anyone in your Phonebook, Call History. You can also choose to Enter Number.

**Note:** Forwarding a text message is a speed dependent feature and can only be done when the vehicle is traveling at 3 mph (5 km/h) or less.

**Note:** Only one recipient is allowed per text message.

#### **Sending, downloading and deleting your text messages**

**Text messaging is a phone dependent feature.** If your phone is compatible, SYNC allows you to receive, send, download and delete text messages.

To access:

1. Press PHONE or .
2. Scroll until Text Message appears and press OK.

## Entertainment Systems

3. Scroll to select from the following options:

**Send Text Message?:** Enables you to send a new text message based on a predefined set of 15 messages.



1. Press OK to select. If the system detects your phone does not support this feature, *Unsupported* will appear in the display and SYNC will return you to the main menu.

2. Scroll to cycle through the following predefined text message options:

- Can't talk right now
- Call you later
- Be there in 20 minutes
- No
- Thanks
- I need more directions
- Too funny
- I'm stuck in traffic
- Call me
- Yes
- Why?
- Where R you?
- I love you
- Can't wait to see you
- Be there in 10 minutes

4. Press OK when the desired selection is in the display. The system will now need to know to whom you would like to send the message.

5. Scroll to cycle through Phonebook or Call History entries. You can also select Enter Number to audibly enter a desired number.

6. Press OK to enter the desired menu and scroll to select the specific contact.

7. Press OK when the contact appears and press OK again to confirm when the system asks if you would like to send the message.

**Note:** Each text message will be sent with the following signature: "This message was sent from my <*Ford or Lincoln*>."

**Download Unread Msgs:** Allows you to download your unread messages (only) to SYNC.

- Press OK to select. The display will indicate your messages are being downloaded. When complete, SYNC will take you to your inbox.

## Entertainment Systems

**Delete All Messages?:** Allows you to delete current text messages from SYNC (not your phone).

- Press OK to select. The display will indicate when all your text messages have been deleted and SYNC will return you to the text message menu.

**Note:** SYNC does not automatically download all of your unread text messages at every ignition cycle (as it does with call history and phonebook if automatic download is set to on).

**Delete All Messages?:** Press OK to exit the current menu.

### Accessing your phone settings

**These are phone dependent features.** Your phone settings allow you to access and adjust features such as your ring tone, text message notification, modifying your phone book and also setting up automatic download.

To access:

1. Press PHONE or .
2. Scroll until Phone Settings appears and press OK.
3. Scroll to select from the following options:

**Phone Status:** Shows you the provider, name, signal power, battery power and roaming status of your connected phone.

- Press OK to select and scroll to view the information. When done, press OK again to return to the phone status menu.

**Set Ringer:** Allows you to select which ring tone will sound during an incoming call (one of the system's or your phone's).

- Press OK to select and scroll to hear Ringer 1, Ringer 2, Ringer 3 and Phone Ringer. Press OK to select.

**Note:** If your phone supports in-band ringing, your phone's ringer will sound when Phone Ringer is chosen.

**Message Notification :** Gives you the option of hearing an audible tone to notify you when a text message has arrived.

- Press OK to select and scroll to select between Message Notification On or Message Notification Off . Press OK to select.

## Entertainment Systems

**Modify Phonebook:** Allows you to modify the contents of your phone book (i.e. add, delete, download).

↳ Press OK to select and scroll to cycle through the following options:

- **Add Contacts:** Press OK to add more contacts from your phone book. 'Push' the desired contact(s) on your phone. Refer to your phone's user guide on how to 'push' contacts.
- **Delete Phonebook:** Press OK to delete the current phone book and call history. When Delete Phonebook appears, press OK to confirm. SYNC will take you back to the Phone Settings menu.
- **Download Phonebook:** Press OK to select and press OK again when Confirm Download? appears.
- **Delete Contact:** Press OK to delete a specific contact. When *Select Contact* appears, press OK again and scroll until the name is selected. Press OK to select and again to confirm. **Note:** If automatic download is on, the contact may appear on the next automatic download.

**Auto Download:** Allows you to automatically download your cellular phone's phone book each time your phone connects to SYNC.

- ↳
- Press OK to select. When Auto Download On? appears, press OK to have your phonebook automatically download each time. Downloading times are phone and quantity dependent. **Note:** When auto download is on, any changes, additions or deletions saved since your last download will be deleted.
  - Select *Off* to NOT download your phonebook every time your phone connects to SYNC. **Note:** Your phonebook, call history and text messages can only be accessed when your specific phone is connected to SYNC.

**Return:** Press OK to exit the current menu.

### System settings

System Settings provide access to your Bluetooth Devices and Advanced menu features.

The Bluetooth Devices menu allows you to add, connect, delete and set a phone as 'primary' as well as turn your Bluetooth feature on and off.

The Advanced menu allows you to access and set prompts, languages, defaults, perform a master reset, install an application and view system information.

## Entertainment Systems

See the following sections for more information and also the following graphic for the system settings menu layout.

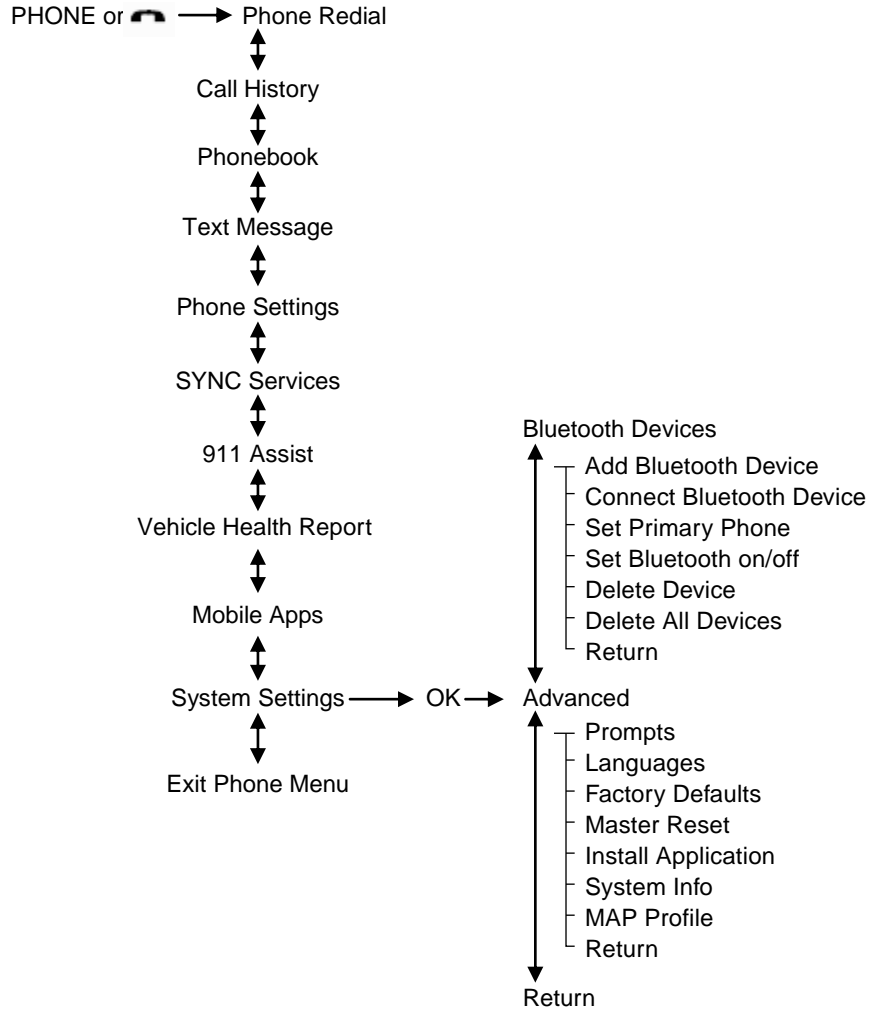

## Entertainment Systems

**Scrolling through the menus:** Press ▲ / ▼ on your audio system to scroll through the menu options.

### **Bluetooth Device menu options**

This menu allows you to add, connect, delete, set a phone as primary, as well as turn *Bluetooth* on and off.

To access:

1. Press PHONE or  to enter the Phone Menu.
2. Scroll until System Settings appears and press OK.
3. Scroll until Bluetooth Devices appears and select OK.
4. Scroll to select from the following options:

**Add Bluetooth Device: This is a speed dependent feature** which allows you to pair additional phones to the system.

1. Press OK to select and press OK again when Find SYNC appears in the display.
  2. Follow the directions in your phone's user guide to put your phone into discovery mode. A six digit PIN will appear in the display.
  3. When prompted on your phone's display, enter the six digit PIN provided by SYNC.
  4. When Set As Primary Phone? appears, press OK. Scroll to toggle between Yes and No and press OK.
- Note:** Setting a phone as *primary* means that SYNC will attempt to connect to this phone first at every ignition cycle.
5. Depending on the functionality of your phone, you may be asked additional questions, such as if you would like to download your phonebook or activate 911 Assist (if equipped). Scroll and use OK to select the desired responses.

**Connect Bluetooth Device:** Allows you to connect a previously paired *Bluetooth* enabled phone.

1. Press OK to select and view a list of previously paired phones.
  2. Scroll until the desired device is chosen and press OK to connect the phone.
- Note:** Only one device can be connected at a time. When another phone is connected, the previous one will be disconnected.

## Entertainment Systems

**Set As Primary Phone?:** Select to set a previously paired phone as your primary phone. SYNC will attempt to connect with the primary phone at every ignition cycle.

- Press OK to select and scroll to select the desired phone. Press OK to confirm.

**Note:** When a phone is selected as primary, it will appear first in the list and will be marked with an \*.

**Set Bluetooth On/Off:** Allows you to turn the *Bluetooth* feature on /off.

- Press OK and scroll to toggle between On and Off. When the desired selection is chosen, press OK.

**Note:** Turning Off *Bluetooth* will disconnect all *Bluetooth* devices and deactivate all *Bluetooth* features.

**Delete Device:** Allows you to delete a paired phone.

- Press OK and scroll to select the device. Press OK to confirm.

**Delete All Devices:** Allows you to delete all previously paired phones.

- Press OK to select.

**Note:** Deleting a phone will also delete all information in SYNC originally saved with that phone.

**Return:** Press OK to exit the current menu.

### **Advanced menu options**

This menu allows you to access settings such as prompts, languages, defaults, perform a master reset, install an application and view system information.

To access:

1. Press PHONE or  to enter the Phone Menu.
2. Scroll until System Settings appears and press OK.
3. Scroll until Advanced appears and select OK.
4. Scroll to select from the following options:

**Prompts:** Prompts from SYNC can help guide you using questions, helpful hints or asking you for a specific action. To turn these prompts on or off:

-  1. Press OK to select and scroll to select between on or off.
2. Press OK when the desired selection appears in the display. SYNC will take you back to the Advanced menu.



## Entertainment Systems

**Languages:** Allows you to choose from three languages: English, Francais and Espanol. Once selected, all of SYNC's radio displays and prompts will be in the selected language.

1. Press OK to select and then scroll through English, Francais and Espanol.
2. Press OK when the desired selection appears in the display.

**Note:** If you change the language setting, the display will indicate that the system is updating. When complete, SYNC will take you back to the Advanced menu.

**Factory Defaults:** Allows you to return to the factory default settings. This selection will NOT erase your indexed information (phonebook, call history, text messages and paired devices).

1. Press OK to select and then press OK again when Restore Defaults? appears in the display.
2. Press OK to confirm.

**Master Reset:** Allows you to completely erase ALL information stored on SYNC (all phonebook, call history, text messages and all paired devices) and return to the factory default settings.

- Press OK to select. The display will indicate when complete and SYNC will take you back to the Advanced menu.

**Install Application?:** Allows you to install applications you have downloaded.

- Press OK and scroll to select. Press OK to confirm.

**System Info:** Allows you to access the Auto Version number as well as the FDN number.

- Press OK to select.

**MAP Profile:** Message Access Profile is a *Bluetooth* component which can further help your phone with the exchange of text messages.

**Return:** Press OK to exit the current menu.

## Entertainment Systems

### Accessing and using your SYNC applications and Services (if equipped)

In addition to the standard phone and media options which SYNC offers, your system also includes advanced features such as:

- **911 Assist™:** Can alert 911 in the event of an emergency.
- **Vehicle Health Report (if equipped, U.S. only):** Provides a diagnostic and maintenance report card of your vehicle.
- **Traffic, Directions and Information (if equipped, U.S. only):** Provides access to Traffic, Directions and information such as travel, horoscopes, stock prices and more.

In order for these features to work, your cellular phone must be compatible with SYNC. To check your phone's compatibility, please visit [www.SyncMyRide.com](http://www.SyncMyRide.com) or [www.syncmaroute.ca](http://www.syncmaroute.ca).

Refer to the following sections for more information on each feature.

### SYNC® Services: Traffic, Directions & Information (TDI), if equipped, U.S. only

**Note:** SYNC® with Traffic, Directions & Information Services requires activation prior to use. Visit [www.SyncMyRide.com](http://www.SyncMyRide.com) to register as you must register to use the service. You must also have a paired and connected *Bluetooth* enabled cellular phone in order to connect to SYNC® Traffic, Directions & Information Services. Refer to the *Phone Features* chapter for pairing instructions.

SYNC® Services uses advanced vehicle sensors, integrated GPS technology and comprehensive map and traffic data, to give you personalized traffic reports, precise turn-by-turn directions, business search, news, sports, weather and more. For a complete list of services, or to learn more, please visit [www.SyncMyRide.com](http://www.SyncMyRide.com).

### To connect to SYNC® Traffic, Directions & Information Services using voice commands:

1. Press **Ⓜ**.
2. When prompted, say, "Services". This initiates an outgoing call to SYNC® TDI Services using your paired and connected *Bluetooth* enabled cellular phone.
3. Once connected, follow the voice prompts to request your desired service such as "Traffic" or "Directions". You can also say, "What are my choices?" to receive a complete list of available services from which to choose.
4. To return to the services main menu, say "Services" or for help, simply say, "Help".

## Entertainment Systems

### **To connect to SYNC® Traffic, Directions & Information Services using the phone menu:**

1. Press  or PHONE to enter the Phone Menu.
2. Scroll repeatedly until *Services* appears in the display.
3. Press OK to confirm and enter the Services menu. The display will indicate the system is connecting.
4. Press OK. SYNC® will initiate the call to the services portal.
5. Once connected, follow the voice prompts to request your desired Service such as Traffic or Directions. You can also say, “What are my choices?” to receive a complete list of available services from which to choose.
6. To return to the services menu, say “Services” or for help, simply say, “Help”.

### **To disconnect from SYNC® Services (TDI) you can:**

- Press and hold the phone button (  ) on the steering wheel.
- Say “Goodbye” from the SYNC Services main menu.

### **Receiving Turn by Turn Directions:**

1. When connected to the Services portal, say “Directions” or “Business Search”.
2. Follow the voice prompts to select your Destination. Once your destination is selected, your current vehicle location is uploaded and a route based on current traffic conditions is calculated and sent back to your vehicle . After the route download is complete, the phone call is automatically ended. You will receive driving instructions via audible prompts.
3. While on an active route, you can select or say ‘Route Summary or ‘Route Status’ to view the Route summary turn list or the Route Status ETA. You can also turn voice guidance on or off, cancel the route or update the route.

**Personalizing Traffic, Directions and Information:** Your Traffic, Directions and Information Services can be personalized to provide quicker access to your most used or favorite information. You can save address points such as, ‘work’ or ‘home’. You can also save favorite information like sports teams, such as ‘Detroit Lions’, or a news category. To learn more, log onto [www.SyncMyRide.com](http://www.SyncMyRide.com).

**Push to interrupt:** You can, at any time while you are connected to SYNC TDI Services, press  to interrupt a voice prompt or an audio clip (such as a sports report) and say your voice command.

## Entertainment Systems

**Portable:** Your SYNC TDI Services subscription is associated with your *Bluetooth* enabled cellular phone number, not your VIN (Vehicle Identification Number). Thus, you can use your SYNC TDI Service with any vehicle equipped with Traffic, Directions and Information. Simply pair and connect your phone to any vehicle equipped with Traffic, Directions and Information and continue enjoying your personalized services.

**Note:** The driver is ultimately responsible for the safe operation of the vehicle, and therefore, must evaluate whether it is safe to follow the suggested directions. Any navigation features are provided only as an aid. Make your driving decisions based on your observations of local conditions and existing traffic regulations. Do not follow the route suggestions if doing so would result in an unsafe or illegal maneuver, if you would be placed in an unsafe situation, or if you would be directed into an area that you consider unsafe. Maps used by this system may be inaccurate because of errors, changes in roads, traffic conditions or driving conditions.

**Note:** When you connect to Traffic, Directions and Information, the service uses GPS technology and advanced vehicle sensors to collect the vehicle's current location, travel direction and speed to help provide you with the directions, traffic reports, or business searches you request. Further, to provide the services you request and for continuous improvement, the service may collect and record call details and voice communications. For more information, see Traffic, Directions and Information, Terms and Conditions at [www.SyncMyRide.com](http://www.SyncMyRide.com). If you do not want Ford or its service providers to collect the vehicle travel information or other information identified in the Terms and Conditions, do not activate or use the service.

**Note: SYNC® with Traffic, Directions & Information Services requires activation prior to use. Visit [www.SyncMyRide.com](http://www.SyncMyRide.com) to register.** Standard phone and message rates may apply. Subscription may be required. To register and check your eligibility for free services, log onto [www.SyncMyRide.com](http://www.SyncMyRide.com).

**Note: Traffic, Directions & Information Services will not function properly if you have enabled caller ID blocking on your mobile phone. Prior to using SYNC TDI Services, ensure that your mobile phone is not blocking caller ID.**

## Entertainment Systems

### 911 Assist™ (if equipped)

**For 911 Assist™ to function properly, the vehicle must have battery power after the crash, the cell phone must be previously paired, connected to SYNC®, and continue to function properly with the ability to make and maintain a 911 call initiated by SYNC®, and the 911 Assist™ feature must be previously enabled (set to ON).**



**WARNING:** Do not wait for 911 Assist™ to initiate an emergency call if you are capable yourself. Dial emergency services immediately to avoid delayed response time, which could increase the risk of serious injury or death after a crash. If you do not hear 911 Assist™ within 5 seconds after the crash, the system or phone may be damaged or non-functional.

**The cell phone or 911 Assist™ hardware may become damaged in a crash, the vehicle may lose battery power, or the cell phone may be thrown from the vehicle, which could prevent operation. Additionally, every cell phone operates differently. While SYNC®, 911 Assist™ works with most cell phones, some may have trouble using this feature. Finally, not all crashes deploy an airbag or, in certain vehicles, activate the fuel pump shut-off which are the criteria to initiate 911 Assist™.**

Airbags generally deploy in certain frontal, near frontal, side and rollover crashes, and the deployment of any airbag is intended to act as a 911 Assist™ trigger if those events occur. For more information about airbag deployment, see the *Seating and Safety Restraints* chapter of your Owner Guide. The fuel pump shut-off, in certain vehicles, is intended to act as a trigger for 911 Assist™ in rear-end crashes, in which airbags generally do not deploy. To determine if your vehicle has this trigger, check the *Roadside Emergency* chapter in your Owner's Guide. If your Owner Guide describes a "Fuel Pump Shut-off", it will trigger 911 Assist™. If your Owner Guide describes a "Fuel Pump Shut-off *Switch*", it will not trigger 911 Assist™.



**WARNING:** Always place cell phone in a secure location to prevent it from becoming a projectile or becoming damaged in the event of a collision. Failure to do so may cause serious injury or damage the phone which could prevent 911 Assist from functioning properly.

## Entertainment Systems

**911 ASSIST™ PRIVACY NOTICE:** Once 911 Assist™ is enabled (set to ON), 911 Assist™ may, through any paired and connected cell phone, disclose to emergency services that the vehicle has been in a crash involving the deployment of an airbag or, in certain vehicles, the activation of the fuel pump shut-off. Certain versions or updates to 911 Assist™ may also be capable of electronically or verbally disclosing to 911 operators the vehicle location, and/or other details about the vehicle or crash to assist 911 operators to provide the most appropriate emergency services. If you do not want to disclose this information, do not enable (set to ON) the feature.

**Note:** If 911 Assist™ is enabled/disabled by any user, the current setting will apply for all paired phones. If the 911 Assist™ setting is disabled (set to OFF), a voice message and/or display item will inform the vehicle occupants when a previously paired phone connects to SYNC® at vehicle start up.

In the event of a crash involving the deployment of an airbag or the activation of the fuel pump shut-off, in certain vehicles, SYNC® is designed to assist occupants in attempting to contact emergency services by dialing 911 through the occupant's paired and connected *Bluetooth* enabled cellular phone. In the event that a connected cellular phone is damaged or loses connection to SYNC®, SYNC® will search for and connect to any available, previously paired cell phone and attempt to place the call to 911. Before initiating the call, SYNC® provides a short window of time (approximately 10 seconds) that allows the driver or passenger to decide whether to cancel the call by pressing and holding  or PHONE on the steering wheel controls or on the audio system. Before initiating the 911 call for the occupants, SYNC® will say the following or a similar message:

“SYNC® will attempt to call 911. If you wish to cancel the call, press and hold the phone button.”

If the call is not cancelled and a successful call is made, a pre-recorded message will be played for the 911 operator and then the occupant(s) in the vehicle will be able to communicate with the 911 operator.

**Note:** Failure to cancel the call as described above will result in SYNC® dialing 911.

**Note:** When you are connected to the 911 operator, be prepared to provide your name, phone number and location immediately, because not all 911 systems are capable of receiving this information electronically.

## Entertainment Systems

The following steps are required for the 911 Assist™ feature to perform properly:

- SYNC® is on and functioning properly at the time of the incident and throughout feature activation and use.
- SYNC® 911 Assist™ feature is set to ON prior to the incident.
- A *Bluetooth* enabled and compatible cellular phone is paired and connected to SYNC®.
- A connected *Bluetooth* enabled cellular phone that has the ability to make and maintain an outgoing call at the time of the incident.
- A connected *Bluetooth* enabled cellular phone that has adequate network coverage, battery power and signal strength.
- The vehicle is located in the U.S. or Canada or in a territory in which 911 is the emergency number.



**WARNING:** Unless 911 Assist™ is previously configured to ON prior to a crash, 911 Assist™ will not dial for help during an emergency, which could delay response time, increasing the risk of serious injury or death after a crash.

The 911 Assist™ feature is initially set to OFF. To access the setting:

1. Press  or PHONE to enter the Phone Menu.
2. Scroll repeatedly until 911 Assist appears in the radio display.
3. Press OK to confirm and enter the 911 Assist menu.
4. Scroll to select between On and Off selections.
5. Press OK when the desired option appears in the radio display. Set On or Set Off will appear in the display as confirmation.

**Note:** Off selections include: Off with reminder and Off without reminder. Off with reminder provides a display and voice reminder at phone connection at vehicle start. Off without reminder provides a display reminder only without a voice reminder.

For more information, please visit [www.SyncMyRide.com](http://www.SyncMyRide.com) or [www.syncmaroute.ca](http://www.syncmaroute.ca).

**Note: Before enabling (setting to ON), review the 911 Assist™ Privacy Notice.**

## Entertainment Systems

### Vehicle health report (if equipped, U.S. only)



**WARNING:** Always follow scheduled maintenance instructions, regularly inspect your vehicle, and seek repair for any damage or problem you suspect. Vehicle Health Reports supplements, but cannot replace normal maintenance and vehicle inspection. Vehicle Health Report only monitors certain systems that are electronically monitored by the vehicle and will not monitor or report the status of any other system, (i.e., brake lining wear). Failure to perform scheduled maintenance and regularly inspect your vehicle may result in vehicle damage and serious injury.

**Note: Your Vehicle Health Report feature requires activation prior to use. Visit [www.SyncMyRide.com](http://www.SyncMyRide.com) to register.** There is no fee or subscription associated with Vehicle Health Report, but you **must** register to use this feature.

SYNC® allows you to check your vehicle's overall 'health' in the form of diagnostic report card. The vehicle health report contains valuable information such as:

- Vehicle Diagnostic Information
- Scheduled maintenance
- Open Recalls and Field Service Actions
- Unserviced items from vehicle inspections by your authorized dealer

**VEHICLE HEALTH REPORT PRIVACY NOTICE: When you run a Vehicle Health Report, Ford Motor Company may collect your cell phone number (to process your report request) and diagnostic information about your vehicle. Certain versions or updates to Vehicle Health Report may also collect additional vehicle information. Ford may use the vehicle information it collects for any purpose. If you do not want to disclose your cell phone number or vehicle information, do not run the feature or set up your Vehicle Health Report profile at [www.SyncMyRide.com](http://www.SyncMyRide.com). Refer to [www.SyncMyRide.com](http://www.SyncMyRide.com) — Vehicle Health Report Terms and Conditions, and Privacy Statement — for more information.**



## Entertainment Systems

You can initiate a Vehicle Health Report in the vehicle and view the complete report with all information listed above on SyncMyRide.com. You can also choose for SYNC® to automatically remind you to run reports at specific mileage intervals. After you've registered for the Vehicle Health Report service and established your preferences at [www.SyncMyRide.com](http://www.SyncMyRide.com), you can then request a Vehicle Health Report (in your vehicle) and return to your account at [www.SyncMyRide.com](http://www.SyncMyRide.com) to view your report. Cell phone airtime usage may apply when reporting.

To access and run a report (after the vehicle has been running a minimum of 60 seconds):

1. Press PHONE to enter Phone Menu.
2. Scroll until *Vehicle Health* is selected and press OK.
3. Scroll to select from the following options:



- **User Preferences:** Press OK to select and enter the menu.

Scroll to select from:

- **Automatic Reports:** Press OK and select on or off. Select 'On' to have SYNC automatically prompt you to run a health report at certain mileage intervals. **Note:** You must first turn this feature 'on' before you can select the mileage intervals at which you would like to be prompted.

- **Mileage Intervals:** Press OK. Scroll to select between 5,000, 7,500 or 10,000 mile intervals and press OK to make your selection.

- **Return:** Press OK to exit the menu.

- **Run Report:** Press OK for SYNC to run a health report of your vehicle's diagnostic systems and send the results to Ford where it will be combined with scheduled maintenance information, open recalls and other field service actions and un-serviced vehicle inspection items from your authorized dealer.

**Note:** This feature may not function properly if you have enabled caller ID blocking on your mobile phone. Before running a report, review Vehicle Health Report Privacy Notice.

## Entertainment Systems

### **SYNC® AppLink™ (if equipped, U.S. only)**

SYNC® AppLink™ is a software application which allows you to connect to and use applications on your smartphone such as Pandora and Stitcher via your SYNC system (provided your phone is compatible with these features).

To see trouble shooting tips, available applications, and a list of supported smart phone devices, please visit [www.SyncMyRide.com](http://www.SyncMyRide.com).

#### **To access from the media menu:**

1. Press AUX and then MENU.
2. When *Media Player Menu* is selected, press OK.
3. Scroll to cycle through the following options:
  - Play Menu
  - Select Source
  - *Media Settings*
  - Mobile Apps
  - System Settings
  - *Exit Media Menu*
4. When Mobile Apps appears in the display, press OK to enter the menu and view a list of available applications (for example, Pandora).
5. Once started, you may then press MENU to access Media Menu.
6. Scroll to access the desired application menu (for example, Pandora) and press OK. From here, you can access the features which accompany the application such as Thumbs up, Thumbs Down, etc. For more information, please visit [www.SyncMyRide.com](http://www.SyncMyRide.com)

**Note:** You can also access by pressing  and, when prompted, saying “Mobile Apps”. You can then say the name of the smart phone application (for example, Pandora) after the tone. Your smart phone *must* be paired and connected in order to use this feature.

## Entertainment Systems

### To access from the phone menu:

1. Press  or PHONE to enter the Phone Menu.
2. Scroll repeatedly until Mobile Apps appears in the display.
3. Press OK to enter the menu and view a list of available applications (for example, Pandora).
4. Scroll to access the desired application menu (for example, Pandora menu) and press OK. From here you can access the features which accompany the application such as Thumbs up, Thumbs down, etc. For more information, please visit [www.SyncMyRide.com](http://www.SyncMyRide.com).

**Note:** iPhone® users need to connect the phone to the USB port in order to start an application.

**Note:** If using an iPhone®, it is recommended that the phone is locked after starting the application.

### Media features with SYNC

SYNC® allows you to access and play music from your digital music player over the vehicle's speaker system using the system's media menu or voice commands.

You can also choose to sort and play your music by specific metadata categories such as:



- Artists
- Albums
- Genres
- Playlists
- Tracks
- Similar Music

### Compatibility

SYNC is capable of hosting nearly any digital media player including: iPod®, Zune™, “Plays from device” players, and most USB drives.

SYNC will also support audio formats such as MP3, WMA, WAV and ACC.

## Entertainment Systems

### Connecting your digital media player to SYNC® via the USB port

**Note:** If your digital media player has an On/Off switch, ensure that the device is turned On.

1. Plug the device into the vehicle's USB port.
2. Press AUX and then MENU.
3. When *Media Player Menu* is selected, press OK.
3. Depending on how many digital media files are on your connected device, Indexing may appear in the radio display until indexing is complete. You will then be taken to the Play Menu.
4. Press OK and scroll through selections of:
  - Play All
  - Albums
  - Genres
  - Playlists
  - Tracks
  - Explore USB
  - Similar Music
  - Return
5. When the desired selection appears in the display, press OK to build your desired music selection.

For more information, refer to *Accessing your play menu* later in this chapter.

### **What's playing?**

At any time while a track is playing, you can press  and say, "What's playing?". SYNC will read the metadata tags of the playing track to you (if populated).

## Entertainment Systems



### Media voice commands

Press  and when prompted, say, “USB” . You may then say any of the following:

- |                                     |                                     |
|-------------------------------------|-------------------------------------|
| • Play all                          | • Play                              |
| • Pause                             | • What’s playing?                   |
| • Play next track                   | • Play previous track               |
| • Play song <name>                  | • Search song <name>                |
| • Refine song <name>                | • Similar music                     |
| • Play next folder <sup>2</sup>     | • Play previous folder <sup>2</sup> |
| • Autoplay on                       | • Autoplay off                      |
| • Repeat off                        | • Repeat on                         |
| • Shuffle on                        | • Shuffle off                       |
| • Play genre <name> <sup>1</sup>    | • Play playlist <name> <sup>1</sup> |
| • Play album <name> <sup>1</sup>    | • Play artist <name> <sup>1</sup>   |
| • Play track <name> <sup>1</sup>    | • Search artist <name> <sup>1</sup> |
| • Search genre <name> <sup>1</sup>  | • Search track <name> <sup>1</sup>  |
| • Search album <name> <sup>1</sup>  | • Refine album <name> <sup>1</sup>  |
| • Refine artist <name> <sup>1</sup> | • Refine track <name> <sup>1</sup>  |
| • Connections                       |                                     |

<sup>1</sup> Voice commands which are not available until indexing is complete.

<sup>2</sup> Voice commands which are only available in folder mode. For more information, refer to *Exploring the USB device* later in this chapter.

**Note:** In the above possible commands, “<name>” is a dynamic listing in that it could be the name of any desired group, artist, etc.

**Autoplay:** With this feature ON, SYNC® allows you to listen to music which has already been randomly indexed during the indexing process. With this feature OFF, SYNC® will not begin to play any of your music until all media has all been indexed.

**Note:** The larger the number of songs the system has to index, the longer indexing will take. Indexing times can vary from device to device.

## Entertainment Systems

**Search/Play Genre:** You can search for and play a specific genre (type) of music. SYNC® will search all the data from your indexed music and, if available, will begin to play that type of music.

**Note:** You can only play genres of music which are present in the GENRE metadata tags that you have on your digital media player.

**Similar music:** You can tell the system to play music ‘similar’ to what you are currently playing from the USB port. SYNC® will use the metadata information of each indexed song to compile a playlist for you.

**Search/play artist/track/album:** You can search for a specific artist/track or album from the music SYNC® has indexed through the USB port.

**Refine:** This allows you to ‘refine’ your previous commands. For example, if you told SYNC® to search and play all music by a certain artist, you could then tell SYNC® to “refine album” and choose a specific album from the list to view. If you then select ‘Play’, the system will only play music from that specific album.

Press  and when prompted, say, “Bluetooth Audio”. You may then say any of the following:

- |                       |                   |
|-----------------------|-------------------|
| • Play                | • Connections     |
| • Pause               | • Play next track |
| • Play previous track |                   |

## Entertainment Systems

### Maneuvering the media menu

Below is a graphical representation of how the phone menu lays out in your system. It will be explained in more detail in this chapter, but this may help you to better visualize the menu structure.

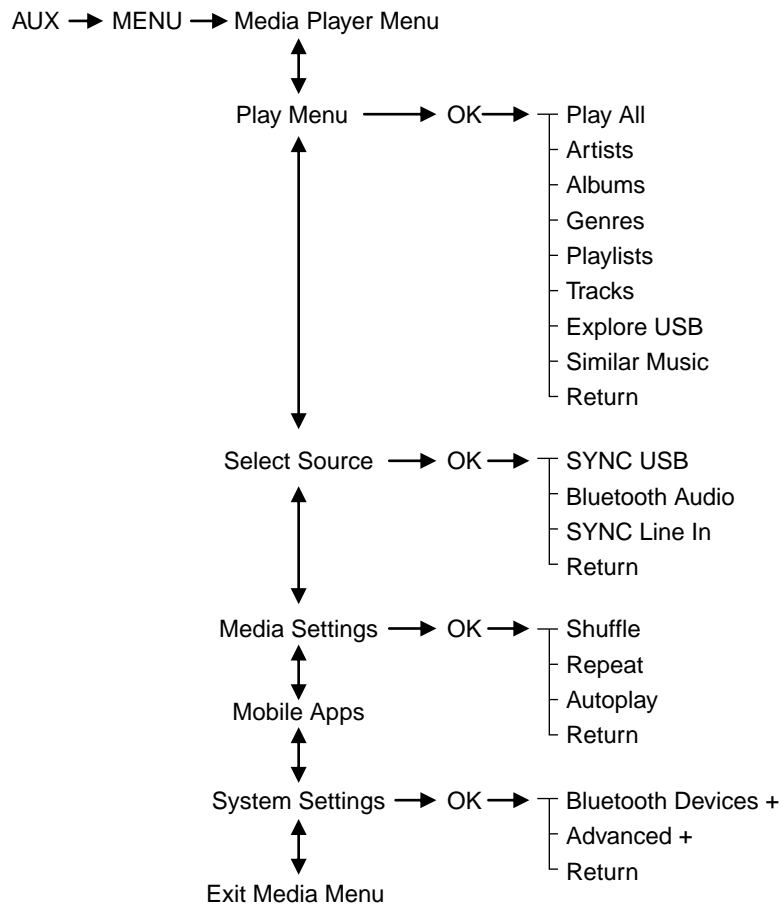

+ Denotes submenus with additional menu items

**Scrolling through the menus:** Press ▲ / ▼ to scroll through the menu options.

## Entertainment Systems

### Accessing the features of your media menu

SYNC's media menu allows you to select which source you would like to listen to, how you would like to play your music (by artist, genre, shuffle, repeat, etc.), and also if you need to add, connect or delete devices.

To access your media menu:

1. Press AUX and then MENU.
2. When *Media Player Menu* is selected, press OK.
3. Scroll to cycle through the following features:

**Play Menu** : Allows you to play your music by artist, album, genre, playlists, tracks, similar music or to simply, play all. You can also choose to Explore USB to view the supported digital music files on your playing device.

Refer to Play Menu later in this section for more information.

**Select Source**: Allows you to select and play music from your USB port, auxiliary input jack (line in) or stream music from your *Bluetooth* enabled phone. Press OK to select and then scroll to choose from:

- \*USB: Press OK to access music plugged into your USB port. SYNC will also allow you to plug in devices to charge them (if supported by your device).
  - **Bluetooth Audio: This is a phone dependent feature** which allows you to stream music playing on your *Bluetooth* enabled phone. If supported by your device, you can press ◀ SEEK ▶ to access the previous/next track.
  - **Line in**: Press OK to select and play music from your portable music player over the vehicle's speakers. **Note**: If you have already connected a device to the USB port, you cannot access the line in feature. Some digital media players require both USB and Line in ports to stream data and music separately.
- \* Once connected, SYNC will index any readable media files. (The time required to complete this depends on the size of the media content being indexed.) If Autoplay is on, you can access media files randomly as they are indexed. If turned off, indexed media is not available until the indexing process is complete. SYNC is capable of indexing thousands of average size media and will notify you if the maximum indexing file size is reached.



## Entertainment Systems

**Media Settings:** Allows you to choose to shuffle or repeat your music in addition to setting your Autoplay settings. Press OK to select and then scroll to choose from:

- **Shuffle:** Press OK to shuffle available media files in the current playlist. **Note:** To shuffle all media tracks, you must select *Play All* in the Play Menu and then select Shuffle.
- **Repeat:** Press OK to repeat any song.
- **Autoplay:** Press OK to listen to music which has already been randomly indexed during the indexing process.

\* You may also press you can press ◀ SEEK ▶ to access the previous/next track.

**Note:** Once these selections are turned on, they will remain on until turned off. Some digital media players require both USB and Line in ports to stream data and music separately.

**Mobile Apps** (if equipped): Enables you to interact with SYNC® capable mobile applications on your smartphone. Refer to SYNC® AppLink™ earlier in this chapter for more information.

**System Settings:** Allows you to access *Bluetooth* Device menu listings (add, connect, set as primary, on/off, delete) as well as Advanced menu listings (prompts, languages, defaults, master reset, install application and system information).

- Please refer to System Settings in this chapter for complete information.

**Exit Media Menu:** Press OK when this appears to exit the media menu.

### Accessing your play menu

The Play menu allows you to select and play your media by artist, album, genre, playlist, track, similar music or even to explore what is on your USB device.

To access:

1. Press AUX and then MENU.
2. When *Media Player Menu* is selected, press OK.
3. Scroll to select the Play Menu and press OK.

## Entertainment Systems

4. If there are no media files to access, the display will indicate there is no media. If there are media files, you will then have the following options to scroll through and select from:

**Play all:** Allows you to play all indexed media (tracks) from your playing device in flat file mode, one at a time in numerical order.

- Press OK to select. The first track title will appear in the display.

**Artists:** Allows you to sort all indexed media by artist. Once selected, the system will list and then play all artists and tracks alphabetically. If there are less than 255 indexed artist, they will be listed alphabetically in flat file mode. If there are more, they will be categorized into alphabetical categories.

1. Press OK to select. You can select to play *All Artists* or any indexed artist.
2. Scroll until the desired artist is chosen and press OK.

**Albums:** Allows you to sort all indexed media by albums. If there are less than 255 indexed albums, they will be listed alphabetically in flat file mode. If there are more, they will be organized into alphabetical categories.

1. Press OK to enter the album menu and select from playing all albums or from any individual indexed album.
2. Scroll until the desired album is chosen and press OK.

**Genres:** Allows you to sort indexed music by genre (category) type. SYNC will list the genres alphabetically in flat file mode. If there are more than 255, SYNC will automatically organize them into alphabetical categories.

- Press OK to select and then scroll to select the desired genre and press OK.

**Playlists:** Allows you to access your playlists. SYNC will list your playlists alphabetically in flat file mode. If there are more than 255, SYNC will automatically organize them into alphabetical categories.

**Note:** SYNC supports many playlist formats such as: .ASX, .M3U, .WPL, .MTP.

- Press OK to select. Then scroll to select the desired playlist and press OK.

## Entertainment Systems

**Tracks:** Allows you to search for and play a specific track which has been indexed. SYNC will list your tracks alphabetically in flat file mode. If there are more than 255, SYNC will automatically organize them into alphabetical categories.

- Press OK to select. Then scroll to select the desired track and press OK.

**Explore USB:** Allows you to explore through all supported digital media on your media device connected to the USB port. **Note:** When exploring, you will only be able to view media content which is compatible with SYNC. You may have other files saved with various extensions, but they will not be visible.

- Press OK to select. Then scroll to explore indexed media on your flash drive.

**Similar Music:** Allows you to play music similar to what is currently playing from the USB port. The system uses the metadata information of each song to compile a playlist for you.

- Press OK to select. The system will create a new list of similar songs and begin playing. **Note:** Your metadata tags must be populated in order for this feature to include each track. **Note:** With certain playing devices, if your metadata tags are not populated, the tracks won't be available in voice recognition, play menu or similar music. However, if you place these tracks onto your playing device in "Mass Storage Device Mode", they will be available in voice recognition, play menu browsing and similar music. "Unknown" will be placed into any unpopulated metadata tag.

**Return:** Press OK to exit the current menu.

### System settings

System settings provide access to your Bluetooth Devices and Advanced menu features.

The Bluetooth Devices menu allows you to add, connect and delete a device as turn the *Bluetooth* feature on and off.

Your Advanced menu allows you to access and set prompts, languages, defaults and perform a master reset.

## Entertainment Systems

See the following sections for more information on these menus as well as the following graphic for the menu layout.

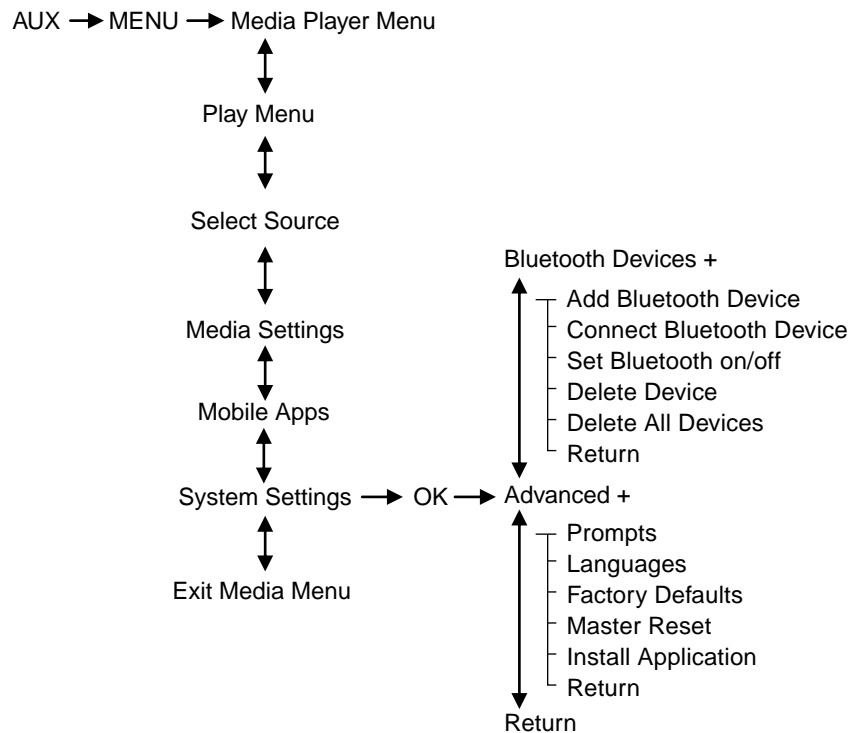

**Scrolling through the menus:** Press ▲ / ▼ to scroll through the menu options.

## Entertainment Systems

### **Bluetooth Device menu options**

This menu allows you to add, connect and delete devices as well as turn *Bluetooth* on and off.

To access:

1. Press AUX and then MENU.
2. When *Media Player Menu* is selected, press OK.
3. Scroll until System Settings appears and select OK.
4. Scroll until Bluetooth Devices appears.
5. Press OK and then scroll to select from the following:

**Add Bluetooth Device: This is a speed dependent feature** which allows you to pair additional devices to the system.

- ↳ 1. Press OK to select and press OK again when Find SYNC appears in the display.
2. Follow the directions in your phone's user guide to put your phone into discovery mode. A six digit PIN will appear in the display.
3. When prompted on your phone's six digit display, enter the PIN. You can now change SYNC sources to BT Audio and stream music from your device.

**Connect Bluetooth Device:** Allows you to connect a previously paired *Bluetooth* enabled phone.

- ↳ 1. Press OK to select and view a list of devices.
2. Scroll until the desired device is chosen and press OK to connect the device.

**Set Bluetooth On/Off:** Allows you to turn the *Bluetooth* feature on /off.

- Press OK and scroll to toggle between On and Off. When the desired selection is chosen, press OK.

**Note:** Turning Off *Bluetooth* will disconnect all *Bluetooth* devices and deactivate all *Bluetooth* features.

**Delete Device:** Allows you to delete a paired media device.

- Press OK and scroll to select the device. Press OK to confirm.

**Delete All Devices:** Allows you to delete all previously paired devices.

- Press OK to select.

**Return:** Press OK to exit the current menu.

## Entertainment Systems

### **Advanced menu options**

This menu allows you to access settings such as prompts, language, performing a master reset as well as returning to factory defaults.

To access:

1. Press AUX and then MENU.
2. When *Media Player Menu* is selected, press OK.
3. Scroll until System Settings appears and select OK.
4. Scroll until Advanced appears.
5. Press OK and then scroll to select from the following:

**Prompts:** Prompts from SYNC can help guide you via questions, helpful hints or ask you for a specific action. To turn these prompts on or off:

- ↳ 1. Press OK to select and scroll to select between on or off.
- 2. Press OK when the desired selection appears in the display. SYNC will take you back to the Advanced menu.

**Languages:** Allows you to choose from three languages: English, Francais and Espanol. Once selected, all of SYNC's radio displays and prompts will be in the selected language.

- ↳ 1. Press OK to select and then scroll through English, Francais and Espanol.
- 2. Press OK when the desired selection appears in the display.

**Note:** If you change the language setting, the display will indicate that the system is updating. When complete, SYNC will take you back to the Advanced menu.

**Factory Defaults:** Allows you to return to the factory default settings. This selection will NOT erase your indexed information (phonebook, call history, text messages and paired devices).

1. Press OK to select and then press OK again when Restore Defaults? appears in the display.
2. Press OK to confirm.

**Master Reset:** Allows you to completely erase ALL information stored on SYNC (all phonebook, call history, text messages and all paired devices) and return to the factory default settings.

- Press OK to select. The display will indicate when complete and SYNC will take you back to the Advanced menu.

## Entertainment Systems

**Application (if available):** You can download new software application (if available) and then load the desired applications onto SYNC through your USB port. Refer to the web site for more information.

**Return :** Press OK to exit the current menu.

### Troubleshooting

Your SYNC® system is easy to use. However, should questions arise, please refer to the tables below as well as the *Helpful Hints* section that follows.

Use the website at any time to check your phone's compatibility, register your account and set preferences as well as access a customer representative via an on-line chat (during certain hours). Visit [www.SyncMyRide.com](http://www.SyncMyRide.com) or [www.syncmaroute.ca](http://www.syncmaroute.ca) for more information.

Phone issues		
Issue	Possible Cause(s)	Possible Solution(s)
There seems to be a lot of background noise during a phone call.	The audio control settings on your phone may be affecting the performance of SYNC.	Review your phone's user guide regarding audio adjustments.
During a call, I can hear the other person but they can't hear me.	Possible phone malfunction.	Try turning off the device, resetting or removing the battery of the device and try again.
SYNC is not able to download my phonebook.	<ul style="list-style-type: none"> <li>• This is a phone dependent feature.</li> <li>• Possible phone malfunction.</li> </ul>	<ul style="list-style-type: none"> <li>• Go to the web site to review your phone's compatibility.</li> <li>• Try turning off the device, resetting the device or removing the battery of the device, then try again.</li> <li>• Try "pushing" your phonebook contacts to SYNC by using the Add Contacts feature.</li> <li>• Use the "SYNCmyphone" feature available on the web site.</li> </ul>

## Entertainment Systems

Phone issues		
Issue	Possible Cause(s)	Possible Solution(s)
The system says “Phonebook Downloaded” but my phonebook in SYNC is empty or is missing contacts.	Limitations on your phone’s capability.	<ul style="list-style-type: none"> <li>• Try ‘pushing’ your phonebook contacts to SYNC by using the Add Contacts feature.</li> <li>• If the missing contacts are stored on your SIM card, try moving them to the device memory.</li> </ul> Remove any pictures or special ring tones associated with the missing contact.
I’m having trouble connecting my phone to SYNC.	<ul style="list-style-type: none"> <li>• This is a phone dependent feature.</li> <li>• Possible phone malfunction.</li> </ul>	<ul style="list-style-type: none"> <li>• Go to the web site to review your phone’s compatibility.</li> <li>• Try turning off the device, resetting the device or removing the battery of the device then try again.</li> <li>• Try deleting your device from SYNC, and deleting SYNC on your device then try to pair again.</li> <li>• Check the security and “auto accept/prompt always” settings relative to the SYNC <i>Bluetooth</i> connection on your phone.</li> <li>• Update your device’s software firmware.</li> <li>• Turn off the Auto phonebook download setting.</li> </ul>
Text messaging is not working on SYNC.	<ul style="list-style-type: none"> <li>• This is a phone dependent feature.</li> <li>• Possible phone malfunction.</li> </ul>	<ul style="list-style-type: none"> <li>• Go to the website to review your phone’s compatibility.</li> <li>• Try turning off the device, resetting the device or removing the battery of the device then try again.</li> </ul>



## Entertainment Systems

USB/Media issues		
Issue	Possible Cause(s)	Possible Solution(s)
I'm having trouble connecting my device.	Possible device malfunction.	<ul style="list-style-type: none"> <li>• Try turning off the device, resetting the device or removing the battery of the device and try to connect your device again.</li> <li>• Ensure that you are using the manufacturer's cable.</li> <li>• Ensure that the USB cable is properly inserted into your device and the USB port in the vehicle.</li> <li>• Ensure that your device does not have an auto—install program or active security settings.</li> </ul>
SYNC does not recognize my device when I turn on the car.	This is a device limitation.	Ensure that you are not leaving your device in your vehicle during very hot or cold temperatures.
<i>Bluetooth</i> audio won't stream.	<ul style="list-style-type: none"> <li>• This is a phone dependent feature.</li> <li>• The device is not connected.</li> </ul>	<ul style="list-style-type: none"> <li>• Ensure that the device is connected to SYNC and that you have pressed play on your device.</li> </ul>
SYNC doesn't recognize music that is on my device.	<ul style="list-style-type: none"> <li>• Your music files may not contain the proper artist, song title, album or genre information.</li> <li>The file may be corrupted.</li> <li>The song may have copyright protection which does not allow it to play.</li> </ul>	<ul style="list-style-type: none"> <li>• Ensure that all song details are populated.</li> <li>• Some devices require you to change the USB settings from mass storage to MTP class.</li> </ul>

## Entertainment Systems

Vehicle Health Report/Services (Traffic, Directions and Information) issues		
Issue	Possible Cause(s)	Possible Solution(s)
I received a text that the Vehicle Health Report isn't activated.	Your account may not be activated on the web site or you may have the wrong VIN (vehicle identification number) listed.	<ul style="list-style-type: none"> <li>• This is a free feature, but you must first register online to use it. Ensure that you have registered your account on the website.</li> <li>• Ensure that your VIN is correctly listed in your account.</li> </ul>
I'm unable to retrieve the report on the web site, or I received a system error.	The preferred dealer information did not load correctly.	When you register your account, you must list a preferred dealer. If one is already listed, try selecting another dealer and logging back out. Then, log back in and change it back to your preferred dealer and retrieve the report.
I'm unable to submit a report.	<ul style="list-style-type: none"> <li>• This could be due to your phone's compatibility, bad signal strength or your phone may not be activated on the web site.</li> </ul>	<ul style="list-style-type: none"> <li>• Update your mobile number in your account on the web site.</li> <li>• Ensure that you have full signal strength and that your <i>Bluetooth</i> volume level has been turned up.</li> <li>• Try deleting your phone and performing a clean pairing.</li> </ul>
I heard a commercial when I tried to use Traffic, Directions and Information.	<ul style="list-style-type: none"> <li>• The phone in use is not activated.</li> <li>• Your phone has ID blocker active.</li> </ul>	<ul style="list-style-type: none"> <li>• This is a free feature, but you must first register online to use it. Ensure that you have registered your account on the web site.</li> <li>• Turn off ID blocker on your phone as the system recognizes you by your phone number. Ensure that the currently connected phone is the same one that is registered on your SyncMyRide account.</li> </ul>



## Entertainment Systems

<b>Voice command issues</b>		
<b>Issue</b>	<b>Possible Cause(s)</b>	<b>Possible Solution(s)</b>
SYNC does not understand what I am saying.	<ul style="list-style-type: none"> <li>• You may be using the wrong voice commands.</li> <li>• You may be speaking too soon or at the wrong time.</li> </ul>	<ul style="list-style-type: none"> <li>• Review the Phone voice commands and the Media voice commands at the beginning of their respective chapters.</li> <li>• Be aware that SYNC's microphone is either in your rear mirror or in the headliner just above the windshield.</li> </ul>
SYNC does not understand the name of a song or artist.	<ul style="list-style-type: none"> <li>• You may be using the wrong voice commands.</li> <li>• You may not be saying the name exactly as it is saved.</li> <li>• The system may not be "reading" the name the same way you are saying it.</li> </ul>	<ul style="list-style-type: none"> <li>• Review the media voice commands at the beginning of the media chapter.</li> <li>• Say the song or artist exactly as they are listed. If you say, "Play Artist Prince", the system will not play music by Prince and the Revolution or Prince and the New Power Generation.</li> <li>• Ensure that you are saying the complete title such as "California remix featuring Jennifer Nettles".</li> <li>• If the songs are saved in all CAPS, you will have to spell them. LOLA will require you to say, "Play L-O-L-A"</li> <li>• Don't use special characters in the title as the system will not recognize them.</li> </ul>

## Entertainment Systems

Voice command issues		
Issue	Possible Cause(s)	Possible Solution(s)
SYNC does not understand or is calling the wrong contact when I want to make a call.	<ul style="list-style-type: none"> <li>You may be using the wrong voice commands.</li> <li>You may not be saying the name exactly as it is saved.</li> <li>Contacts in your phonebook may be very short and similar, or they may contain special characters.</li> <li>Your phonebook contacts may be saved in CAPS.</li> </ul>	<ul style="list-style-type: none"> <li>Review the phone voice commands at the beginning of the phone chapter.</li> <li>Ensure that you are saying the contacts exactly as they are listed. For example, if a contact is saved as Joe Wilson, say, "Call Joe Wilson".</li> <li>The system does better if you list full names such as "Joe Wilson" rather than "Joe".</li> <li>Don't use special characters such as 123 or ICE as the system will not recognize them.</li> <li>If contacts are saved in CAPS, you will have to spell them. JAKE will require you to say, " Call J-A-K-E."</li> </ul>

### Helpful Hints

- Ensure that the interior of the vehicle is as quiet as possible. Wind noise from open windows and road vibrations may prevent the system from correctly recognizing spoken voice commands.
- Ensure that you are speaking naturally and without any large pauses between words.
- After you push  to begin a voice session, wait until the prompt sounds and *Listening* appears in the display. Anything spoken prior to this will not register with the system.
- You can, at any time, interrupt the system while it is speaking by pushing  during an active voice session. The system will respond with a listening prompt and allow you to speak a command.
- For a list of available voice commands, you can push  and say, "Help" after the tone. The system will audibly list voice commands available in your current mode.
- The system's microphone is either located in your rear view mirror or in the headliner just above your windshield. Ensure that the microphone area is kept free of obstructions.

## Entertainment Systems

- To better understand how the system interprets your phone book contacts, select a contact and then scroll until *Speak this* is selected and press OK. The system will read the contact and you can better understand how to say the contact for the next time.
- To better understand how the system interprets your media titles, when the desired selection is playing, push **0/1**, and when prompted, say “What’s playing?”. The system will read the title to you so that you will know how to say the selection so that the system will understand.

### **SYNC® customer support**

If your questions are still not resolved, please contact SYNC® customer support, available Monday through Saturday: 8:30am-8:00pm EST. You can also access on-line support on the web site during these same hours.

**Note:** Times are subject to change due to holidays.

In the United States, call: 1-888-270-1055

In Canada, call: 1-800-565-3673

### **SYNC® End User License Agreement (EULA)**

- You have acquired a device (“DEVICE”) that includes software licensed by FORD MOTOR COMPANY from an affiliate of Microsoft Corporation (“MS”). Those installed software products of MS origin, as well as associated media, printed materials, and “online” or electronic documentation (“MS SOFTWARE”) are protected by international intellectual property laws and treaties. The MS SOFTWARE is licensed, not sold. All rights reserved.
- The MS SOFTWARE may interface with and/or communicate with, or may be later upgraded to interface with and/or communicate with additional software and/or systems provided by FORD MOTOR COMPANY. The additional software and systems of FORD MOTOR COMPANY origin, as well as associated media, printed materials, and “online” or electronic documentation (“FORD SOFTWARE”) are protected by international intellectual property laws and treaties. The FORD SOFTWARE is licensed, not sold. All rights reserved.
- The MS SOFTWARE and/or FORD SOFTWARE may interface with and/or communicate with, or may be later upgraded to interface with and/or communicate with additional software and/or systems provided by third party software and service suppliers. The additional software and services of third party origin, as well as associated media, printed materials, and “online” or electronic documentation (“THIRD PARTY SOFTWARE”) are protected by international intellectual property laws and treaties. The THIRD PARTY SOFTWARE is licensed, not sold. All rights reserved.

## Entertainment Systems

- The MS SOFTWARE, FORD SOFTWARE and THIRD PARTY SOFTWARE hereinafter collectively and individually will be referred to as "SOFTWARE."

**IF YOU DO NOT AGREE TO THIS END USER LICENSE AGREEMENT ("EULA"), DO NOT USE THE DEVICE OR COPY THE SOFTWARE. ANY USE OF THE SOFTWARE, INCLUDING BUT NOT LIMITED TO USE ON THE DEVICE, WILL CONSTITUTE YOUR AGREEMENT TO THIS EULA (OR RATIFICATION OF ANY PREVIOUS CONSENT).**

**GRANT OF SOFTWARE LICENSE:** This EULA grants you the following license:

- You may use the SOFTWARE as installed on the DEVICE and as otherwise interfacing with systems and/or services provide by or through FORD MOTOR COMPANY or its third party software and service providers.

### **DESCRIPTION OF OTHER RIGHTS AND LIMITATIONS:**

- **Speech Recognition:** If the SOFTWARE includes speech recognition component(s), you should understand that speech recognition is an inherently statistical process and that recognition errors are inherent in the process. Neither FORD MOTOR COMPANY nor its suppliers shall be liable for any damages arising out of errors in the speech recognition process.
- **Limitations on Reverse Engineering, Decompilation and Disassembly:** You may not reverse engineer, decompile, or disassemble nor permit others to reverse engineer, decompile or disassemble the SOFTWARE, except and only to the extent that such activity is expressly permitted by applicable law notwithstanding this limitation.
- **Limitations on Distributing, Copying, Modifying and Creating Derivative Works:** You may not distribute, copy, make modifications to or create derivative works based on the SOFTWARE, except and only to the extent that such activity is expressly permitted by applicable law notwithstanding this limitation.
- **Single EULA:** The end user documentation for the DEVICE and related systems and services may contain multiple EULAs, such as multiple translations and/or multiple media versions (e.g., in the user documentation and in the software). Even if you receive multiple EULAs, you are licensed to use only one (1) copy of the SOFTWARE.
- **SOFTWARE Transfer:** You may permanently transfer your rights under this EULA only as part of a sale or transfer of the DEVICE, provided you retain no copies, you transfer all of the SOFTWARE (including all component parts, the media and printed materials, any

## Entertainment Systems

upgrades, and, if applicable, the Certificate(s) of Authenticity), and the recipient agrees to the terms of this EULA. If the SOFTWARE is an upgrade, any transfer must include all prior versions of the SOFTWARE.

- **Termination:** Without prejudice to any other rights, FORD MOTOR COMPANY or MS may terminate this EULA if you fail to comply with the terms and conditions of this EULA.
- **Security Updates/Digital Rights Management:** Content owners use the WMDRM technology included in your DEVICE to protect their intellectual property, included copyrighted content. Portions of the SOFTWARE on your DEVICE use WMDRM software to access WMDRM-protected content. If the WMDRM software fails to protect the content, content owners may ask Microsoft to revoke the SOFTWARE's ability to use WMDRM to play or copy protected content. This action does not affect unprotected content. When your DEVICE downloads licenses for protected content, you agree that Microsoft may include a revocation list with the licenses. Content owners may require you to upgrade the SOFTWARE on your DEVICE to access their content. If you decline an upgrade, you will not be able to access content that requires the upgrade.
- **Consent to Use of Data:** You agree that MS, Microsoft Corporation, FORD MOTOR COMPANY, third party software and systems suppliers, their affiliates and/or their designated agent may collect and use technical information gathered in any manner as part of product support services related to the SOFTWARE or related services. MS, Microsoft Corporation, FORD MOTOR COMPANY, third party software and services suppliers, their affiliates and/or their designated agent may use this information solely to improve their products or to provide customized services or technologies to you. MS, Microsoft Corporation, FORD MOTOR COMPANY, third party software and systems suppliers, their affiliates and/or their designated agent may disclose this information to others, but not in a form that personally identifies you.
- **Internet-Based Services Components:** The SOFTWARE may contain components that enable and facilitate the use of certain Internet-based services. You acknowledge and agree that MS, Microsoft Corporation, FORD MOTOR COMPANY, third party software and service suppliers, their affiliates and/or their designated agent may automatically check the version of the SOFTWARE and/or its components that you are utilizing and may provide upgrades or supplements to the SOFTWARE that may be automatically downloaded to your DEVICE.

## Entertainment Systems

- **Additional Software/Services:** The SOFTWARE may permit FORD MOTOR COMPANY, third party software and service suppliers, MS, Microsoft Corporation, their affiliates and/or their designated agent to provide or make available to you SOFTWARE updates, supplements, add-on components, or Internet-based services components of the SOFTWARE after the date you obtain your initial copy of the SOFTWARE (“Supplemental Components”).

If FORD MOTOR COMPANY or third party software and services suppliers provide or make available to you Supplemental Components and no other EULA terms are provided along with the Supplemental Components, then the terms of this EULA shall apply.

If MS, Microsoft Corporation, their affiliates and/or their designated agent make available Supplemental Components, and no other EULA terms are provided, then the terms of this EULA shall apply, except that the MS, Microsoft Corporation or affiliate entity providing the Supplemental Component(s) shall be the licensor of the Supplemental Component(s).

FORD MOTOR COMPANY, MS, Microsoft Corporation, their affiliates and/or their designated agent reserve the right to discontinue without liability any Internet-based services provided to you or made available to you through the use of the SOFTWARE.

- **Links to Third Party Sites:** The MS SOFTWARE may provide you with the ability to link to third party sites through the use of the SOFTWARE. The third party sites are not under the control of MS, Microsoft Corporation, their affiliates and/or their designated agent. Neither MS nor Microsoft Corporation nor their affiliates nor their designated agent are responsible for (i) the contents of any third party sites, any links contained in third party sites, or any changes or updates to third party sites, or (ii) webcasting or any other form of transmission received from any third party sites. If the SOFTWARE provides links to third party sites, those links are provided to you only as a convenience, and the inclusion of any link does not imply an endorsement of the third party site by MS, Microsoft Corporation, their affiliates and/or their designated agent.
- **Obligation to Drive Responsibly:** You recognize your obligation to drive responsibly and keep attention on the road. You will read and abide with the DEVICE operating instructions particularly as they pertain to safety and assumes any risk associated with the use of the DEVICE.



## Entertainment Systems

**UPGRADES AND RECOVERY MEDIA:** If the SOFTWARE is provided by FORD MOTOR COMPANY separate from the DEVICE on media such as a ROM chip, CD ROM disk(s) or via web download or other means, and is labeled “For Upgrade Purposes Only” or “For Recovery Purposes Only” you may install one (1) copy of such SOFTWARE onto the DEVICE as a replacement copy for the existing SOFTWARE, and use it in accordance with this EULA, including any additional EULA terms accompanying the upgrade SOFTWARE.

**INTELLECTUAL PROPERTY RIGHTS:** All title and intellectual property rights in and to the SOFTWARE (including but not limited to any images, photographs, animations, video, audio, music, text and “applets,” incorporated into the SOFTWARE), the accompanying printed materials, and any copies of the SOFTWARE, are owned by MS, Microsoft Corporation, FORD MOTOR COMPANY, or their affiliates or suppliers. The SOFTWARE is licensed, not sold. You may not copy the printed materials accompanying the SOFTWARE. All title and intellectual property rights in and to the content which may be accessed through use of the SOFTWARE is the property of the respective content owner and may be protected by applicable copyright or other intellectual property laws and treaties. This EULA grants you no rights to use such content. All rights not specifically granted under this EULA are reserved by MS, Microsoft Corporation, FORD MOTOR COMPANY, third party software and service providers, their affiliates and suppliers. Use of any on-line services which may be accessed through the SOFTWARE may be governed by the respective terms of use relating to such services. If this SOFTWARE contains documentation that is provided only in electronic form, you may print one copy of such electronic documentation.

**EXPORT RESTRICTIONS:** You acknowledge that the SOFTWARE is subject to U.S. and European Union export jurisdiction. You agree to comply with all applicable international and national laws that apply to the SOFTWARE, including the U.S. Export Administration Regulations, as well as end-user, end-use and destination restrictions issued by U.S. and other governments. For additional information, see <http://www.microsoft.com/exporting/>.

**TRADEMARKS:** This EULA does not grant you any rights in connection with any trademarks or service marks of FORD MOTOR COMPANY, MS, Microsoft Corporation, third party software or service providers, their affiliates or suppliers.

**PRODUCT SUPPORT:** Product support for the SOFTWARE is not provided by MS, its parent corporation Microsoft Corporation, or their affiliates or subsidiaries. For product support, please refer to FORD

## Entertainment Systems

MOTOR COMPANY instructions provided in the documentation for the DEVICE. Should you have any questions concerning this EULA, or if you desire to contact FORD MOTOR COMPANY for any other reason, please refer to the address provided in the documentation for the DEVICE.

**No Liability for Certain Damages:** EXCEPT AS PROHIBITED BY LAW, FORD MOTOR COMPANY, ANY THRID PARTY SOFTWARE OR SERVICES SUPPLIERS, MS, MICROSOFT CORPORATION AND THEIR AFFILIATES SHALL HAVE NO LIABILITY FOR ANY INDIRECT, SPECIAL, CONSEQUENTIAL OR INCIDENTAL DAMAGES ARISING FROM OR IN CONNECTION WITH THE USE OR PERFORMANCE OF THE SOFTWARE. THIS LIMITATION SHALL APPLY EVEN IF ANY REMEDY FAILS OF ITS ESSENTIAL PURPOSE. IN NO EVENT SHALL MS, MICROSOFT CORPORATION AND/OR THEIR AFFILIATES BE LIABLE FOR ANY AMOUNT IN EXCESS OF U.S. TWO HUNDRED FIFTY DOLLARS (U.S.\$250.00).

- THERE ARE NO WARRANTIES OTHER THAN THOSE THAT MAY EXPRESSLY BE PROVIDED FOR YOUR NEW VEHICLE.

### ***End user notice***

#### ***Microsoft® Windows® Mobile for Automotive Important Safety Information***

This system Ford SYNC™ contains software that is licensed to Manufacturer FORD MOTOR COMPANY by an affiliate of Microsoft Corporation pursuant to a license agreement. Any removal, reproduction, reverse engineering or other unauthorized use of the software from this system in violation of the license agreement is strictly prohibited and may subject you to legal action.

### **Read and follow instructions**

Before using your Windows Automotive-based system, read and follow all instructions and safety information provided in this end user manual (“User’s Guide”). Not following precautions found in this User’s Guide can lead to an accident or other serious consequences.

### **Keep User’s Guide in Vehicle**

When kept in the vehicle, the User’s Guide will be a ready reference for you and other users unfamiliar with the Windows Automotive-based system. Please make certain that before using the system for the first time, all persons have access to the User’s Guide and read its instructions and safety information carefully.

## Entertainment Systems



**WARNING:** Operating certain parts of this system while driving can distract your attention away from the road, and possibly cause an accident or other serious consequences. Do not change system settings or enter data non-verbally (using your hands) while driving. Stop the vehicle in a safe and legal manner before attempting these operations. This is important since while setting up or changing some functions you might be required to distract your attention away from the road and remove your hands from the wheel.

### **General operation**

#### **Voice Command Control**

Functions within the Windows Automotive-based system may be accomplished using only voice commands. Using voice commands while driving allows you to operate the system without removing your hands from the wheel.

#### **Prolonged Views of Screen**

Do not access any function requiring a prolonged view of the screen while you are driving. Pull over in a safe and legal manner before attempting to access a function of the system requiring prolonged attention. Even occasional short scans to the screen may be hazardous if your attention has been diverted away from your driving task at a critical time.

#### **Volume Setting**

Do not raise the volume excessively. Keep the volume at a level where you can still hear outside traffic and emergency signals while driving. Driving while unable to hear these sounds could cause an accident.

#### **Use of Speech Recognition Functions**

Speech recognition software is inherently a statistical process which is subject to errors. It is your responsibility to monitor any speech recognition functions included in the system and address any errors.

### **Glossary of terms**

**Autoplay:** With Autoplay turned ON, SYNC® allows you to listen to music which has already been randomly indexed during the indexing process. With Autoplay turned off, the chosen music will not begin to play until all of the music has been indexed by SYNC®. Depending on the size of the material, this may take a few minutes.

**Bluetooth enabled cellular phone:** Any cellular phone which has the *Bluetooth* wireless technology which will enable the phone to connect with SYNC® and exchange information wirelessly.

## Entertainment Systems

**Digital media player / USB Device:** This is a generic term used to signify any of the following media devices: iPod®, Zune™, “Plays from device” players, and most USB drives (thumb drives, flash drives, PEN drives, etc.)

**Discoverable mode:** A mode which allows other *Bluetooth* enabled devices to find your *Bluetooth* enabled device.

**Discovery mode:** A mode which allows your *Bluetooth* enabled device to search for other ‘discoverable’ *Bluetooth* enabled devices.

**In-band ringing:** This is a phone dependent feature. If your *Bluetooth* enabled cellular phone supports this feature, SYNC® can play your ring tone during incoming calls.

**Indexing:** A process in which SYNC® builds a voice recognition grammar for the media content of your digital media player. While indexing, SYNC® will play already indexed media if Autoplay is on. However, voice recognition is not available for the media until the indexing process is complete.

**Metadata:** Descriptive tags embedded in your digital media which provide SYNC® with information such as ARTIST, ALBUM, GENRE and TRACK.

**Pairing:** To use your *Bluetooth* enabled cellular phone with SYNC®, you must go through a pairing (bonding) process. “Pairing” is a special process used when two devices connect for the first time. The pairing process is used to generate a link key that is used for authentication purposes during subsequent *Bluetooth* connections between the two devices.

**PIN (Personal Identification number):** This six digit number (sometimes referred to as a passkey) will be shown in the radio display during the pairing process with your *Bluetooth* enabled device. You do not need to write down this number as it will only be used for that specific pairing procedure.

## Climate Controls

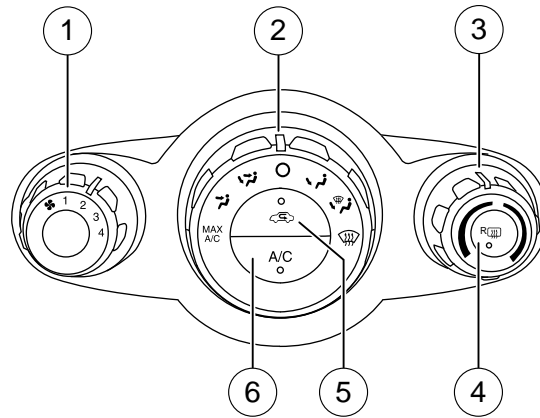

### MANUAL HEATING AND AIR CONDITIONING SYSTEM



Manual system with A/C shown; heater only system similar.



- : Turn to select the desired fan speed.
- Air flow selections:** Controls the direction of the airflow in the vehicle. See the following for a brief description on each control setting:
  - MAX A/C (if equipped):** Distributes recirculated air through the instrument panel vents to cool the vehicle. This re-cooling of the interior air is more economical and efficient than normal A/C mode. Recirculated air may also help reduce undesirable odors from entering the vehicle.
  - : Distributes air through the instrument panel vents. **Note:** You may notice a small amount of air flowing from the floor vents and the rear seat floor vents.
  - : Distributes air through the instrument panel vents, floor vents and rear seat floor vents.
  - : Turns the climate control system off. When the system is off, outside air is prevented from entering the vehicle.
  - : Distributes air through the floor vents and rear seat floor vents. **Note:** You may notice a small amount of air flowing from the demister and defroster vents.
  - : Distributes air through the windshield defroster vents, demisters vents, floor vents and rear seat floor vents.



## Climate Controls

 : Distributes outside air through the windshield defroster and demister vents. Can be used to clear thin ice or fog from the windshield. The system will automatically provide outside air to reduce window fogging. To exit  select another mode.



3. **Temperature:** Controls the temperature of the airflow in the vehicle. For optimum defrosting performance, set the dial to the hottest setting.

4.  : Press to activate/deactivate the rear window defroster. Refer to *Rear window defroster* later in this chapter for more information. If your vehicle is equipped with both rear defroster and heated mirrors, the same button will activate both.

5.  : Press to activate/deactivate air recirculation in the vehicle cabin. Recirculated air may reduce the amount of time required to cool down the interior of the vehicle and may also help reduce undesired odors from reaching the interior of the vehicle. Recirculated air engages automatically when MAX A/C is selected or can be engaged manually in any airflow mode except  (defrost).

6. **A/C (if equipped):** Press to activate/deactivate air conditioning. Use with recirculated air to improve cooling performance and efficiency. Engages automatically in  (defrost),  (floor/defrost) or MAX A/C.

### Operating tips

- To reduce fog build-up on the windshield during humid weather, select  (defrost) or  (floor/defrost).
- To reduce humidity build-up inside the vehicle, do not drive with the system off or with  (recirculated air) engaged and A/C off.
- Do not put objects under the front seats that will interfere with the airflow to the back seats.
- Remove any snow, ice or leaves from the air intake area at the base of the windshield.
- To improve the time to reach comfort in hot weather, drive with the windows slightly open for 2-3 minutes after start up or until the vehicle has been “aired out.”
- A small amount of air may be felt from the floor vent regardless of the air distribution setting that is selected.

During extreme high ambient temperatures when idling stationary for extended periods of time in gear, it is recommended to run the A/C in the MAX A/C position, reduce blower fan speed from the highest setting

## Climate Controls

and put the vehicle's transmission into the P (Park) gear position (automatic transmission only) to continue to receive cool air from your A/C system.

### **For maximum cooling performance in MAX A/C mode:**

1. Select MAX A/C.
2. Select the coolest temperature setting.
3. Set the fan to the highest speed initially. As the interior starts to cool down, adjust the fan speed to maintain comfort.

### **To aid in side window defogging/demisting in cold weather:**

1. Select .
2. Select A/C.
3. Adjust the temperature control to maintain comfort.
4. Set the fan speed to the highest setting.
5. Direct the outer instrument panel vents towards the side windows.

To increase airflow to the outer instrument panel vents, close the vents located in the middle of the instrument panel.

### **REAR WINDOW DEFROSTER**

The rear defroster control is located on the climate control panel and works to clear the rear window of fog and thin ice.

The engine must be running to operate the rear window defroster.

Press  to turn the rear window defroster on. An indicator light on the control will illuminate when active.

**Note:** The rear defroster will turn on automatically when the outside temperature is below 41° F (5° C).

The rear window defroster turns off automatically after a predetermined amount of time, if a low battery condition is detected or when the ignition is turned off or to the accessory position. To manually turn off the rear window defroster at any time, press the control again.

If your vehicle is equipped with both rear defroster and heated mirrors, the same control will activate both. Refer to *Heated outside mirrors* in the *Driver Controls* chapter.

**Do not use razor blades or other sharp objects to clean the inside of the rear window or to remove decals from the inside or the rear window. This may cause damage to the heated grid lines and will not be covered by your warranty.**

## Climate Controls

### CABIN AIR FILTER

Your cabin air filter is located behind the instrument panel. The cabin air filter element is designed to reduce the concentration of airborne particles such as dust, spores and pollen in the air being supplied to the interior of the vehicle. The presence of a particulate filter element provides the following benefits:

- Improves your driving comfort by reducing particle concentration.
- Improves the interior compartment cleanliness.
- Protects the climate control components from particle deposits.

**Note:** A cabin air filter must be installed at all times to prevent foreign objects from entering the system. Running the system without a filter in place could result in degradation or damage to the system. If your vehicle is not equipped with a cabin air filter, a protective screen has been provided in its place and must remain installed at all times.

For replacement intervals regarding the cabin air filter, see the *scheduled maintenance information*. For more information regarding your filter, see your authorized dealer.



## Lights

### HEADLAMP CONTROL

- Turns the lamps off.
- P◄ Turns on the parking lamps, instrument panel lamps, license plate lamps and tail lamps.
- ☰◄ Turns the low beam headlamps on.

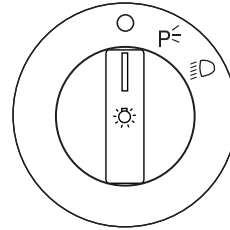

### High beams

Pull the lever fully past the detent to activate. Pull the lever fully again to deactivate.



### Flash-to-pass

Pull the lever toward you slightly to activate and release to deactivate.

### Headlamp exit delay

Switch the ignition off and pull the lever toward you slightly to activate. You will hear a short tone.

The headlamps will turn off automatically after 3 minutes with any door open or 30 seconds after the last door has been closed. With all doors closed, but within the 30 second delay, opening any door will result in the three minute timer starting again.

The headlamp exit delay can be cancelled by either pulling the lever towards the steering wheel again or by turning the ignition switch on.

## Lights

### Daytime running lamps (DRL) (if equipped)

Turns the headlamps on with a reduced output.

To activate:

- the ignition must be in the on position and
- the headlamp control is in the off or parking lamp position.



**WARNING:** Always remember to turn on your headlamps at dusk or during inclement weather. The Daytime Running Lamp (DRL) system does not activate the tail lamps and generally may not provide adequate lighting during these conditions. Failure to activate your headlamps under these conditions may result in a collision.

### PANEL DIMMER CONTROL

Use to adjust the brightness of the instrument panel and all applicable lit components in the vehicle during headlamp and parking lamp operation.

- Tap the top or bottom of the control to brighten/dim all interior lit components incrementally, or
- Press and hold at the first position the top or bottom of the control until the desired lighting level is reached.

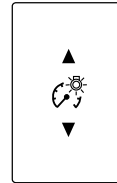

### AIMING THE HEADLAMPS

The headlamps on your vehicle are properly aimed at the assembly plant. If your vehicle has been in an accident, the alignment of your headlamps should be checked by your authorized dealer.

#### Vertical aim adjustment

1. Park the vehicle directly in front of a wall or screen on a level surface, approximately 25 feet (7.6 meters) away.

## Lights

- (1) 8 feet (2.4 meters)
- (2) Center height of lamp to ground
- (3) 25 feet (7.6 meters)
- (4) Horizontal reference line

2. Measure the height of the headlamp bulb center from the ground and mark an 8 foot (2.4 meter) horizontal reference line on the vertical wall or screen at this height.

3. Turn on the low beam headlamps to illuminate the wall or screen and open the hood.

To see a clearer light pattern for adjusting, you may want to block the light from one headlamp while adjusting the other.

On the wall or screen you will observe a flat zone of high intensity light located at the top of the right hand portion of the beam pattern. If the top edge of the high intensity light zone is not at the horizontal reference line, the headlamp will need to be adjusted.

4. Locate the vertical adjuster on each headlamp. Using a Phillips #2 screwdriver or 13 mm wrench/socket, turn the adjuster either clockwise (to adjust down) or counterclockwise (to adjust up). The horizontal edge of the brighter light should touch the horizontal reference line.

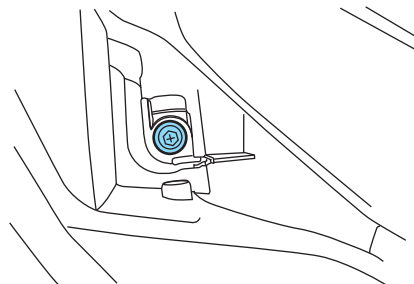
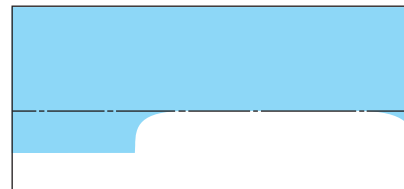
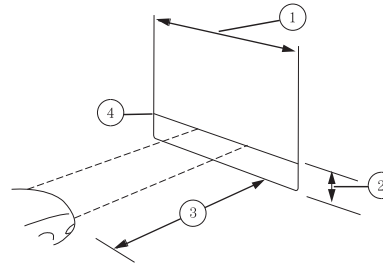

5. Close the hood and turn off the lamps.

**HORIZONTAL AIM IS NOT REQUIRED FOR THIS VEHICLE AND IS NON-ADJUSTABLE.**

## Lights

### TURN SIGNAL CONTROL

- Push down to activate the left turn signal.
- Push up to activate the right turn signal.



When changing lanes, the turn signal indicator can be programmed to flash either one or three times when the stalk is tapped. See *Multifunction display* in the *Instrument cluster* section for more information.

### INTERIOR LAMPS

#### Dome lamps and map lamps with moon roof

Press the buttons to turn the map lamps on/off.

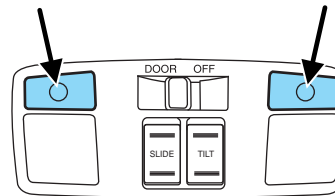

The dome lamp switch has two modes:

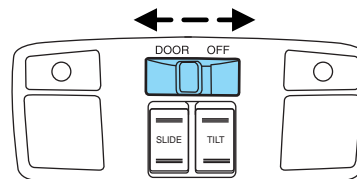

- OFF: The dome lamps will not come on when the doors are opened.
- DOOR: The dome lamps come on when a door is opened.

## Lights

### **Dome lamps and map lamps, rear lamps**

Press the buttons to turn the map lamps on/off.

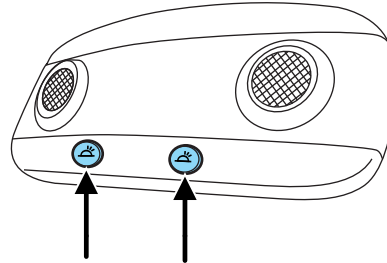

### **Ambient lighting (if equipped)**

Illuminates footwells, cupholders and the instrument panel with a choice of several colors. The ambient lighting control switch is located on the instrument panel. To activate, press and release the control to cycle through the color choices plus the off state.

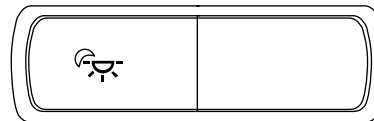

The lights come on whenever the ignition is in either the on or accessory position.

**Note:** The ambient lights will stay on until the ignition is placed in the off position and either of the front doors are opened or the accessory delay timer expires.

### **Battery saver feature (interior lamps)**

The battery saver feature will turn off the interior lamps 10 minutes after the ignition has been turned to the 1 (off) position and one of the vehicle doors has been opened.

**Note:** The battery saver feature will turn off the map lamps after 30 minutes if left in the on position.

## Lights

### BULB REPLACEMENT

#### Lamp assembly condensation

Exterior lamps are vented to accommodate normal changes in pressure. Condensation can be a natural by-product of this design. When moist air enters the lamp assembly through the vents, there is a possibility that condensation can occur when the temperature is cold. When normal condensation occurs, a thin film of mist can form on the interior of the lens. The thin mist eventually clears and exits through the vents during normal operation. Clearing time may take as long as 48 hours under dry weather conditions.

Examples of acceptable condensation are:

- Presence of thin mist (no streaks, drip marks or droplets)
- Fine mist covers less than 50% of the lens

Examples of unacceptable moisture (usually caused by a lamp water leak) are:

- Water puddle inside the lamp
- Large water droplets, drip marks or streaks present on the interior of the lens

Take your vehicle to a dealer for service if any of the above conditions of unacceptable moisture are present.

#### Using the right bulbs

Replacement bulbs are specified in the chart below. Headlamp bulbs must be marked with an authorized "D.O.T." for North America and an "E" for Europe to ensure lamp performance, light brightness and pattern and safe visibility. The correct bulbs will not damage the lamp assembly or void the lamp assembly warranty and will provide quality bulb burn time.

Function	Number of bulbs	Trade number
Headlamp (low beam)	1	H11B
Headlamp (high beam)	1	HB3-9005LL
Headlamp (park/turn)	1	3157NAK (amber)
Headlamp (side marker)	1	168
4-door rear bodyside lamp (park/turn/sidemarker)	1	3157K
4-door rear deck lamp (backup)	1	921

## Lights

Function	Number of bulbs	Trade number
5-door rear lamp (stop/reverse)	2	3157K
5-door rear lamp (turn)	1	3157A (amber)
License plate lamp	1	W5W
* 5-door high-mounted brake lamp	1	LED
* 4-door high-mounted brake lamp	5	W5W
Interior lamp	1	W6W
Reading lamp	1	W5W
Luggage compartment lamp	1	W5W
To replace all instrument panel lights - see your authorized dealer.		
All replacement bulbs are clear in color, except where noted.		
* To replace these lamps, see your authorized dealer.		

### Replacing interior bulbs

Check the operation of all bulbs frequently.

### Replacing exterior bulbs

Check the operation of all the bulbs frequently.

### Replacing bulbs

**Note:** Before changing bulb, verify the corresponding fuse is not blown.  
The low beam headlamps, high beam headlamps, front turn signals and side marker lamps are located in the lamp assembly and can be replaced individually by removing the lamp assembly as a unit.

## Lights

### Removing the front lamp assembly

**Note:** The front lamp assembly must be removed in order to replace bulbs.

1. Make sure the headlamp control is in the off position, then open the hood.
2. Remove the screws and pushpin holding the lamp assembly (1). (Driver side shown)

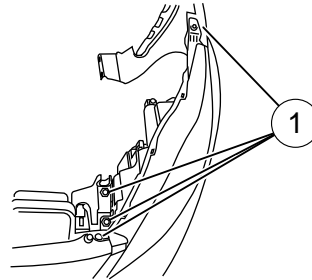

3. Detach the lamp harness clips from the lamp assembly and disconnect the electrical connectors (2).

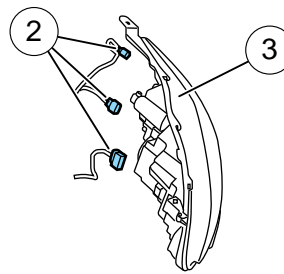

4. Remove the lamp assembly (3).  
**Note:** When lamp is removed, you will hear a clicking sound.

5. Reverse the procedure to install the lamp assembly.

**Note:** When installing the front lamp assembly, the front flange must be placed under the fascia. Ensure that the bottom tab gets placed into the white clip.

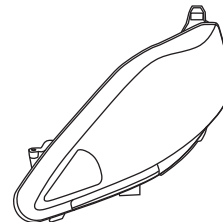



## Lights

### **Replacing the low beam headlamps**

**Note:** The low beam headlamp is the outboard lamp.

**Note:** Never hold a bulb by the glass. This is particularly valid for halogen bulbs as the intensity of the light may be reduced if the hands touch the bulb. If the glass has been handled, clean it with alcohol.

1. Remove the bulb cover.

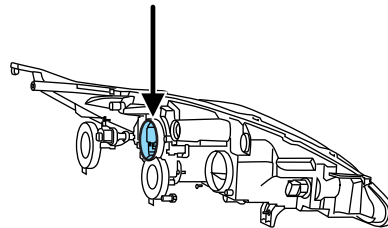

2. Turn the bulb holder counterclockwise and remove it.

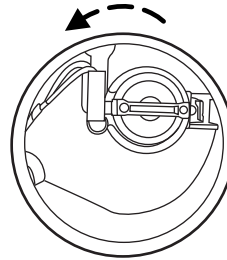

3. Disconnect the electrical connector.

4. Reverse the procedure to install the new bulb

### **Replacing the high beam headlamps**

**Note:** The high beam headlamp is the inboard lamp.

**Note:** Never hold a bulb by the glass. This is particularly valid for halogen bulbs as the intensity of the light may be reduced if the hands touch the bulb. If the glass has been handled, clean it with alcohol.

## Lights

1. Remove the bulb cover.

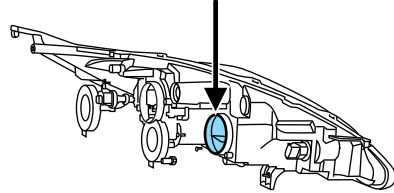

2. Turn the bulb holder counterclockwise and remove it.

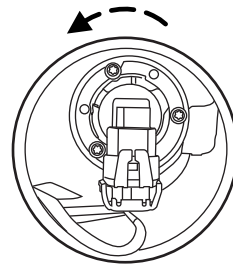

3. Disconnect the electrical connector.
4. Reverse the procedure to install the new bulb.

### **Replacing the park/turn signals**

1. Turn the bulb holder counterclockwise and remove it.

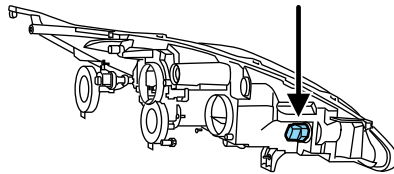

2. Remove the bulb from the bulb holder.

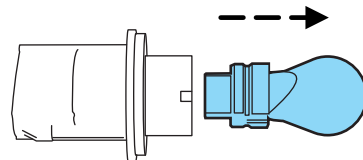

3. Reverse the procedure to install the new bulb.

## Lights

### **Replacing the side marker lamps**

1. Turn the bulb holder clockwise and remove it.

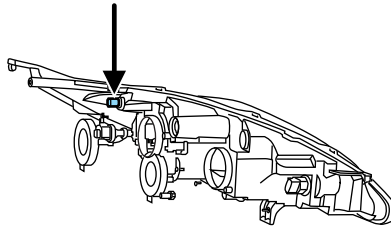

2. Remove the bulb from the bulb holder.

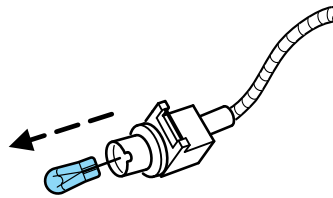

3. Reverse the procedure to install the new bulb.

### **Replacing the signal indicator mirror bulbs (if equipped)**

For bulb replacement, see your authorized dealer.

### **Replacing the rear lamps (5-door)**

1. Open the liftgate.
2. Remove the screws holding the lamp assembly.

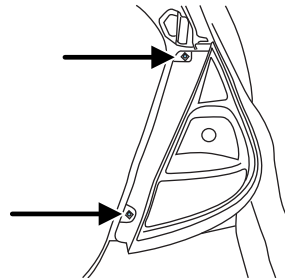

## Lights

### **Replacing the rear stop lamp (5-door)**

1. Turn the bulb holder counterclockwise and remove it.

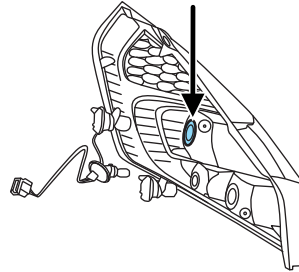

2. Remove the bulb from the holder.

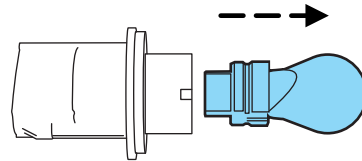

3. Reverse the procedure to install the new bulb.

### **Replacing the reverse signal rear lamp (5-door)**

1. Turn the bulb holder counterclockwise and remove it.

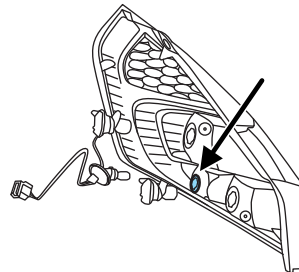

## Lights

2. Remove the bulb from the holder.

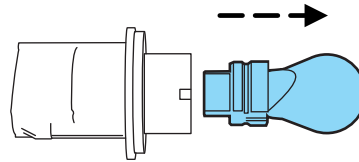

3. Reverse the procedure to install the new bulb.

### **Replacing the turn signal rear lamp (5-door)**

1. Turn the bulb holder counterclockwise and remove it.

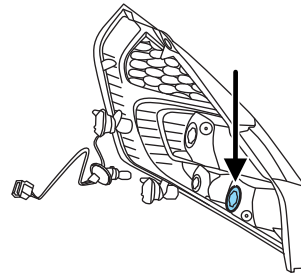

2. Remove the bulb from the holder.

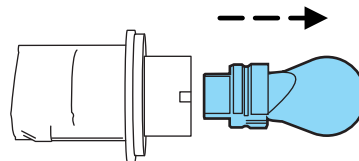

3. Reverse the procedure to install the new bulb.

## Lights

### **Replacing bodyside rear lamp bulb (4-door)**

1. Open the deck lid and remove the interior bodyside carpet.
2. Turn the bulb holder counterclockwise and remove it (2).

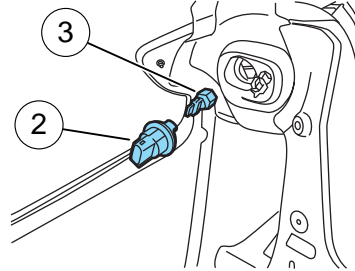

3. Remove the bulb (3) from the holder.

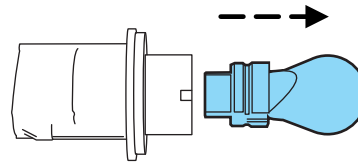

4. Reverse the procedure to install the new bulb.

### **Replacing the decklid mounted reverse lamp bulb (4-door)**

1. Open the deck lid and remove its interior carpet.
2. Turn the bulb holder counterclockwise and remove it (2).

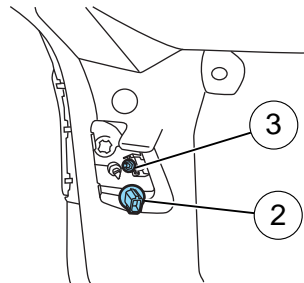

## Lights

3. Remove the bulb (3) from the holder.

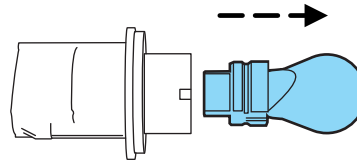

4. Reverse the procedure to install the new bulb.

5. Reinstall the carpet.

### **Replacing the license plate lamps**

1. Carefully release the spring clip (1).

2. Remove the lamp (2).

3. Remove the bulb (3).

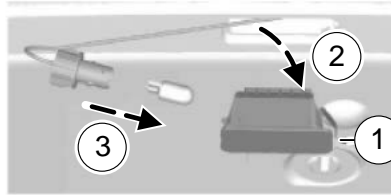

### **Replacing the high-mounted brake lamp**

For replacement, see your authorized dealer.

## Driver Controls

### WINDSHIELD WIPERS

Move the lever down for a single wipe.

 For intermittent operation, move control up one position and adjust the rotary control to the desired speed.

 For normal operation, move control up two positions and up three positions for high-speed wiping.



### Windshield washer

 To activate the windshield washer, press the windshield washer control in. Release control to stop washer fluid spray. The wipers will operate for a short time after the wash is turned off.

**Note:** Do not operate the washer when the washer reservoir is empty. This may cause the washer pump to overheat. Check the washer fluid level frequently. Do not operate the wipers when the windshield is dry. This may scratch the glass, damage the wiper blades and cause the wiper motor to burn out. Before operating the wiper on a dry windshield, always use the windshield washer. In freezing weather, be sure the wiper blades are not frozen to the windshield before operating the wipers.

### Rear window wiper/washer (if equipped)

#### Wiper

 Pull the lever towards you for intermittent wiping.

#### Washer

 Pull the lever farther to operate the washer. The wiper will operate for a short time and will activate once more after pausing to clear the windshield.



## Driver Controls

### TILT/TELESCOPE STEERING WHEEL

To adjust the steering wheel:

1. Pull the lever down to unlock the steering column.
2. While the lever is in the down position, move the steering wheel up or down and in or out until you find the desired position.
3. While holding the steering wheel in place, pull the lever up to its original position to lock the steering column.

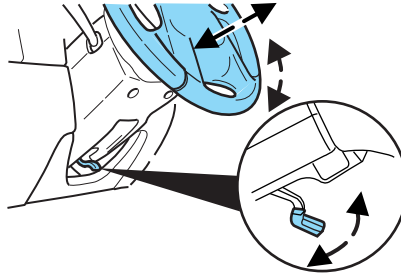

**WARNING:** Never adjust the steering wheel when the vehicle is moving.

### CENTER CONSOLE

Your vehicle has a variety of console features. These include:

- Front cupholders
- Rear cupholder insert
- Coin holders



**WARNING:** Use only soft cups in the cupholder. Hard objects can injure you in a collision.

### AUXILIARY POWER POINT (12V DC)

**Power outlet is designed for accessory plugs only. Do not insert any other object in the power outlet as this will damage the outlet and blow the fuse. Do not hang any type of accessory or accessory bracket from the plug. Improper use of the power outlet can cause damage not covered by your warranty.**

The auxiliary power points can be found in the following locations:

- On the rear of the center console
- On the instrument panel (if equipped)

Do not use the power point for operating the cigarette lighter element (if equipped).

**Note:** Do not plug optional electrical accessories into the cigarette lighter socket (if equipped). Improper use of the lighter can cause damage not covered by your warranty, and can result in fire or serious injury.

## Driver Controls

To prevent the fuse from being blown, do not use the power point(s) over the vehicle capacity of 12V DC/180W. If the power point or cigar lighter socket is not working, a fuse may have blown. Refer to *Fuses and relays* in the *Roadside Emergencies* chapter for information on checking and replacing fuses.

To have full capacity usage of your power point, the engine is required to be running to avoid unintentional discharge of the battery. To prevent the battery from being discharged:

- do not use the power point longer than necessary when the engine is not running,
- do not leave battery chargers, video game adapters, computers and other devices plugged in overnight or when the vehicle is parked for extended periods.

Always keep the power point caps closed when not being used.

### POWER WINDOWS (IF EQUIPPED)



**WARNING:** Do not leave children unattended in the vehicle and do not let children play with the power windows. They may seriously injure themselves.



**WARNING:** When closing the power windows, you should verify they are free of obstructions and ensure that children and/or pets are not in the proximity of the window openings.

Press and pull the window switches to open and close windows.

- Press down (to the first detent) and hold the switch to open.
- Pull up (to the first detent) and hold the switch to close.

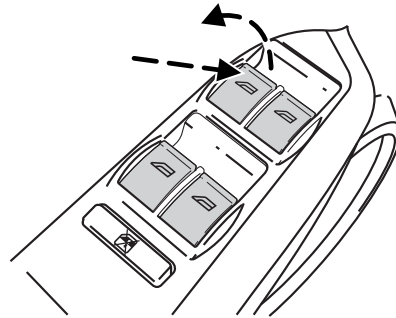

**Rear Window Buffeting:** When one or both of the rear windows are open, the vehicle may demonstrate a wind throb or buffeting noise. This noise can be alleviated by lowering a front window approximately 2–3 inches (5–8 cm).

## Driver Controls

### **One-touch up or down (driver's window only)**

This feature allows the driver's window to open or close fully without holding the control down.

To operate one-touch down, press the switch completely down to the second detent and release quickly. The window will open fully. Momentarily press the switch to any position to stop the window operation.

To operate one-touch up, pull the switch completely up to the second detent and release quickly. The window will close fully. Momentarily press the switch to any position to stop the window operation.

### **Bounce-back (driver's window only)**

When an obstacle has been detected in the window opening as the window is moving upward, the window will automatically move down and stop at a predetermined position.

#### ***Overriding the bounce-back feature***

To override this protection function when there is a resistance, e.g. in the winter, proceed as follows:

1. Close the window twice until it reaches the resistance and let it reverse.
2. Close the window a third time to the resistance. The bounce-back function is disabled and you cannot close the window automatically. The window will override the resistance and you can close it fully.
3. If the window does not close after the third attempt, contact your authorized dealer as soon as possible.

#### ***Resetting the bounce-back feature***



**WARNING:** The bounce-back function is deactivated until you have reset the memory.

After the battery has been disconnected from the vehicle you must reset the bounce-back memory:

1. Pull up the switch and hold until the window is fully closed then release the switch.
2. Pull up the switch again for one more second.
3. Press and hold the switch until the window is fully open, then release the switch.

## Driver Controls

4. Pull up the switch and hold until the window is fully closed.
5. Open the window and try to close it automatically.
6. Reset and repeat procedure if the window does not close automatically.

### Window lock

The window lock feature allows only the driver and front passenger to operate the power windows.



To lock out all window controls (except the driver's and front passenger's) press the control. Press it again to restore the window controls.

**Note:** The rear window switches will not illuminate when the window control is in the locked position.

### INTERIOR MIRROR

The interior rearview mirror has two pivot points on the support arm which lets you adjust the mirror up or down and from side to side.



**WARNING:** Do not adjust the mirror while the vehicle is in motion.

### Automatic dimming interior rear view mirror (if equipped)

The interior rear view mirror has an auto-dimming function. The electronic day/night mirror will change from the normal (high reflective) state to the non-glare (darkened) state when bright lights (glare) reach the mirror. When the mirror detects bright light from behind the vehicle, it will automatically adjust (darken) to minimize glare.

The mirror will automatically return to the normal state whenever the vehicle is placed in R (Reverse) to ensure a bright clear view when backing up.

**Do not block the sensors on the front and back of the interior rear view mirror since this may impair proper mirror performance.**

**Note:** A rear center passenger and/or raised rear center headrest (if equipped) may also block the light from reaching the sensor.

**Do not clean the housing or glass of any mirror with harsh abrasives, fuel or other petroleum-based cleaning products.**

## Driver Controls

### EXTERIOR MIRRORS

#### Power side view mirrors



**WARNING:** Do not adjust the mirror while the vehicle is in motion.

To adjust your mirrors:

1. Rotate the control clockwise to adjust the right mirror and rotate the control counterclockwise to adjust the left mirror.
2. Move the control in the direction you wish to tilt the mirror.
3. Return to the center position to lock mirrors in place.

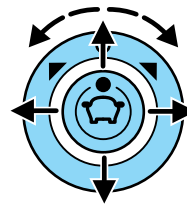

#### **Blind spot mirrors**

Your vehicle is equipped with blind spot mirrors. Refer to *Blind spot mirrors* in the *Driving* chapter.

#### **Heated outside mirrors** (if equipped)

Both mirrors are heated automatically to remove ice, mist and fog when the rear window defrost is activated.

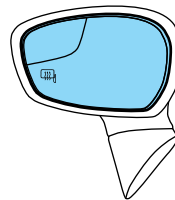

**Do not remove ice from the mirrors with a scraper or attempt to readjust the mirror glass if it is frozen in place. These actions could cause damage to the glass and mirrors.**

**Do not clean the housing or glass of any mirror with harsh abrasives, fuel or other petroleum-based cleaning products.**

## Driver Controls

### Signal indicator mirrors (if equipped)

When the turn signal is activated, the outer portion of the appropriate mirror housing will blink.

This provides an additional warning to other drivers that your vehicle is about to turn.

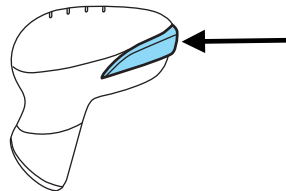

### SPEED CONTROL (IF EQUIPPED)

With speed control set, you can maintain a set speed without keeping your foot on the accelerator pedal.



**WARNING:** Do not use the speed control in heavy traffic or on roads that are winding, slippery or unpaved.

### Using speed controls

The speed controls are located on the steering wheel. The following buttons work with speed control:

**SET+:** Press to set a speed or to increase a set speed.

**CAN (Cancel)/RES (Resume):** Press to cancel or resume a set speed.

**SET-:** Press to decrease a set speed.

**OFF:** Press to turn speed control off.

**ON:** Press to turn speed control on.



### Setting speed control

To set speed control:

1. Press and release ON.
2. Accelerate to the desired speed.
3. Press and release SET+.
4. Take your foot off the accelerator pedal.
5. The indicator  light on the instrument cluster will turn on.

## Driver Controls

### **Note:**

- Vehicle speed may vary momentarily when driving up and down a steep hill.
- If the vehicle speed increases above the set speed on a downhill, you may want to apply the brakes to reduce the speed.
- If the vehicle speed decreases more than 10 mph (16 km/h) below your set speed on an uphill, your speed control will disengage.

### **Disengaging speed control**

To disengage speed control, tap the brake pedal or clutch pedal (if equipped) or press CAN.

Disengaging the speed control will not erase the previous set speed.

**Note:** When you use the clutch pedal to disengage the speed control, the engine speed may briefly increase, this is normal.

### **Resuming a set speed**

Press and release RES. This will automatically return the vehicle to the previously set speed.

### **Increasing speed while using speed control**

To increase the set speed:

- Press and hold SET+ until you get to the desired speed, then release. You can also use SET+ to operate the tap-up function. Press and release SET+ to increase the vehicle set speed in approximately 1 mph (2 km/h) increments.
- Use the accelerator pedal to get to the desired speed then press and release SET+.

### **Reducing speed while using speed control**

To reduce the set speed:

- Press and hold SET- until you get to the desired speed, then release. You can also use SET- to operate the tap-down function. Press and release SET- to decrease the vehicle set speed in approximately 1 mph (2 km/h) increments.
- Press the brake pedal or the clutch pedal (if equipped) until the desired vehicle speed is reached then press SET+.

### **Turning off speed control**



To turn off the speed control, press OFF or turn off the ignition.

**Note:** When you turn off the speed control or the ignition, your speed control set speed memory is erased.



## Driver Controls

### STEERING WHEEL CONTROLS (IF EQUIPPED)

#### SYNC® system hands free control feature

Press  (located on the multi-function lever) briefly to use the voice command feature. You will hear a tone and LISTENING will appear in the radio display. Press and hold  to exit voice command.



Press  to activate phone mode or answer a phone call. Press and hold  to end a call or exit phone mode.

Press  to scroll through various menus and selections. Press OK to confirm your selection.

When SYNC® is not in use, press and release  to select the previous or next radio station preset, CD track or satellite preset (if equipped). Press and hold to move forward or backward to a desired frequency.

**M (Mode):** Press repeatedly to scroll through available audio modes.

For further information on the SYNC® system, refer to the SYNC® supplement.

### MOON ROOF (IF EQUIPPED)

The moon roof control is located on the overhead console.



**WARNING:** Do not let children play with the moon roof or leave children unattended in the vehicle. They may seriously hurt themselves.



**WARNING:** When closing the moon roof, you should verify that it is free of obstructions and ensure that children and/or pets are not in the proximity of the moon roof opening.



## Driver Controls

**To open the moon roof:** Press and release the rear of the SLIDE control and the glass will open automatically. If the sliding shade is closed, it will open along with the moon roof.

**To close the moon roof:** Press and hold the front of the SLIDE control.

**To vent the moon roof:** Press and hold the rear of the TILT control. Press and hold the front of the TILT control to close the moon roof.

The moon roof has a built-in sliding shade that can be manually opened or closed when the glass panel is shut.

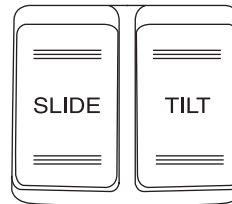

## POSITIVE RETENTION FLOOR MAT



**WARNING:** Always use floor mats that are designed to fit the foot well of your vehicle. Only use floor mats that leave the pedal area unobstructed. Only use floor mats that are firmly secured to retention posts so that they cannot slip out of position and interfere with the pedals or impair safe operation of your vehicle in other ways.

- Pedals that cannot move freely can cause loss of vehicle control and increase the risk of serious personal injury.
- Always make sure that the floor mats are properly attached to the retention posts in the carpet that are supplied with your vehicle. Floor mats must be properly secured to both retention posts to ensure mats do not shift out of position.
- Never place floor mats or any other covering in the vehicle foot well that cannot be properly secured to prevent them from moving and interfering with the pedals or the ability to control the vehicle.

## Driver Controls

### WARNING (Continued)

- Never place floor mats or any other covering on top of already installed floor mats. Floor mats should always rest on top of vehicle carpeting surface and not another floor mat or other covering. Additional floor mats or any other covering will reduce the pedal clearance and potentially interfere with pedal operation.
- Check attachment of floor mats on a regular basis. Always properly reinstall and secure floor mats that have been removed for cleaning or replacement.
- Always make sure that objects cannot fall into the driver foot well while the vehicle is moving. Objects that are loose can become trapped under the pedals causing a loss of vehicle control.
- Failure to properly follow floor mat installation or attachment instructions can potentially cause interference with pedal operation causing loss of control of vehicle.
- To install floor mats, position the floor mat so that the eyelet is over the retention post and press down to lock in.
- To remove the floor mat, reverse the installation procedure.

## Locks and Security

### KEYS

#### Integrated keyhead transmitters (IKTs) (if equipped)

Your vehicle may be equipped with two integrated keyhead transmitters (IKTs). The key blade is used to start the vehicle and unlock/lock the driver's door from outside the vehicle. The transmitter portion functions as the remote entry transmitter.

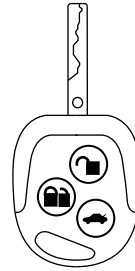

Your IKTs are programmed to your vehicle; using a non-programmed key will not permit your vehicle to start. If you lose one or both of your IKTs, replacements are available through your authorized dealer. Standard SecuriLock® keys without remote entry transmitter functionality can also be purchased from your authorized dealer if desired.

Always carry a spare key with you in case of an emergency.

For more information regarding programming replacement IKTs, refer to the *SecuriLock® passive anti-theft system* section later in this chapter.

**Note:** Your vehicle's IKTs were issued with a security label that provides important vehicle key cut information. It is recommended that you keep the label in a safe place for future reference.

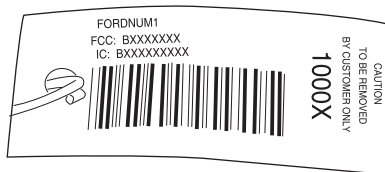

## Locks and Security

### Intelligent Access Key (IA key) (if equipped)

Your vehicle may be equipped with two intelligent access keys which operate the power locks and the remote entry system. You have to have the IA key in the vehicle to activate the push button start system.



The IA key also contains a removable mechanical key blade that can be used to unlock the driver door. To release the mechanical key blade, press the release buttons on the edge of the transmitter and remove the key blade.

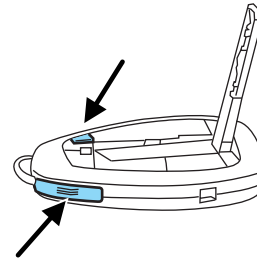

Your IA keys are programmed to your vehicle. You cannot enter or start your vehicle with an unprogrammed key. If you lose one or both of your IA keys, replacements are available from your authorized dealer. For more information on programming replacement IA keys, refer to the *SecuriLock® passive anti-theft system* section in this chapter.

**Note:** Your vehicle's IA backup keys were issued with a security tag that provides important vehicle key cut information. It is recommended that you keep the tag in a safe place for future reference.



## Locks and Security

### POWER DOOR LOCKS

Type 1



Type 2



The power door lock control is located on the instrument panel near the radio.

Press the control to lock/unlock the doors. When the light or lock symbol on the button is on, it indicates that all doors and the trunk are locked. When the light is off it indicates one or more doors are unlocked.

### Rear door unlocking and opening

Pull the interior door release handle twice to unlock/open the rear door. The first pull unlocks the door and the second pull will unlatch the door.

### Smart locks

This feature helps to prevent you from locking yourself out of the vehicle.

If the interior power door lock control is pressed while the driver or front passenger door is open with the key in the ignition, all door locks will lock, and then unlock.

If both front doors are closed, the vehicle can be locked by any method, regardless of whether the key is in the ignition or not.

### Smart locks for intelligent access keys (IA key) (if equipped)

This feature is intended to prevent you from unintentionally locking your IA key inside your vehicle.

If your vehicle's perimeter alarm is in the armed state, the smart locks feature will not allow you to lock your IA key inside the vehicle. When the alarm is armed, if the IA key is detected in the vehicle, the vehicle will automatically unlock. The exterior lights will flash and the horn will chirp twice to indicate the IA key is inside. If your IA key is detected in the trunk (if equipped), the trunk lid will reopen though there will be no feedback from the horn or lights.

## Locks and Security

### Central locking/unlocking

To centrally lock/unlock all doors (from the driver's side only) using the key from the outside when they are closed:

- Turn the key counterclockwise to lock all doors. The turn signal lamps will flash twice.
- Turn the key clockwise once to unlock the driver's door or twice to unlock all doors. The turn signal lamps will flash once.

If the central locking function fails to operate, the doors can be individually locked using the key in the position shown.

On the driver's side, turn the key clockwise to lock, and on the passenger's side turn the key counterclockwise to lock.

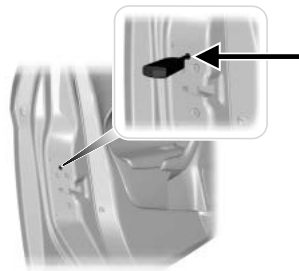

### Delayed Locking

If you try to electrically lock the doors while they are open, they will not lock until the doors are closed. This feature only works when smart locks are not active. See *Smart locks* in this section for more information

### Autolock (if equipped)

The autolock feature will lock all the doors when:

- all doors are closed,
- the ignition is on,
- you shift into any gear putting the vehicle in motion, and
- the vehicle attains a speed greater than 5 mph (7 km/h).

If a door(s) is unlocked, the autolock feature will repeat when:

- the vehicle slows below 5 mph (7 km/h) and then attains a speed greater than 5 mph (7 km/h).

## Locks and Security

### **Autounlock (if equipped)**

If the doors have been autolocked, the doors will autounlock only when:

- the ignition is on,
- all doors are closed,
- the vehicle has been in motion at a speed greater than 12 mph (20 km/h) for more than two seconds,
- the vehicle comes to a stop,
- the ignition is turned off or to accessory,
- the driver door is opened within 10 minutes of the ignition being switched from on to off or accessory.

**Note:** If you use the power door lock button to lock the doors before an autolock event, the doors will not autounlock.

### ***Deactivating and activating autolock or autounlock***

**Note:** When programming the autolock feature, carry out the following steps within 30 seconds or the procedure needs to be repeated. If the procedure needs to be repeated, wait 30 seconds between programming sessions.

1. Turn the ignition on.
2. Press the power door lock control three times.
3. Turn the ignition off.
4. Press the power door lock control three times.
5. Turn the ignition on. The module is now in programming mode.

**Note:** A chime sounds as acknowledgement that the programming mode has been entered. The safety belt must be engaged otherwise the Belt-Minder® chime will take priority over other chimes.

6. Once in programming mode, the autolock or autounlock feature can be programmed independently of each other.
  - To program the autolock feature, press the power door lock control for greater than two seconds and release. Each long press of the power door lock control toggles the state of the autolocking feature between enabled and disabled. A chime sounds when the feature is enabled or disabled.
  - To program the autounlock feature, press the power door lock control for less than 1 second and release. Each short press of the power door lock control toggles the state of the autounlocking feature between enabled and disabled. A chime sounds when the feature is enabled or disabled.
7. Turn the ignition off to exit programming. If a setting was toggled, a chime will be heard.

## Locks and Security

### CHILDPROOF DOOR LOCKS

- When these locks are set, the rear doors cannot be opened from the inside.
- The rear doors can be opened from the outside when the childproof door locks are set, but the doors are unlocked.



The childproof locks are located on the rear edge of each rear door and must be set separately for each door. Setting the lock for one door will not automatically set the lock for both doors.

- On the driver side, turn counterclockwise to lock and clockwise to unlock.
- On the passenger side, turn clockwise to lock and counterclockwise to unlock.

### INTERIOR LUGGAGE COMPARTMENT RELEASE (4-DOOR ONLY)

Your vehicle is equipped with a mechanical interior luggage compartment release handle that provides a means of escape for children and adults in the event they become locked inside the luggage compartment.

Adults are advised to familiarize themselves with the operation and location of the release handle.



## Locks and Security

To open the luggage compartment door (lid) from within the luggage compartment, pull the illuminated “T” shaped handle and push up on the trunk lid. The handle is composed of a material that will glow for hours in darkness following brief exposure to ambient light.

The “T” shaped handle will be located either on the luggage compartment door (lid) or inside the luggage compartment near the tail lamps.

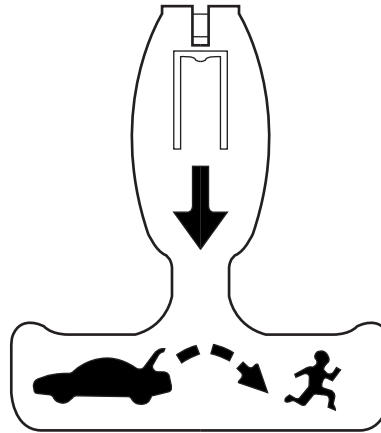

**WARNING:** Keep vehicle doors and luggage compartment locked and keep keys and remote transmitters out of a child's reach. Unsupervised children could lock themselves in the trunk and risk injury. Children should be taught not to play in vehicles.

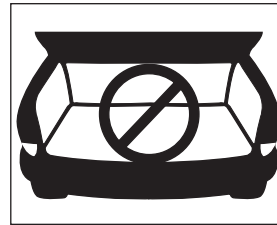

**WARNING:** Do not leave children, unreliable adults, or animals unattended in the vehicle. On hot days, the temperature in the trunk or vehicle interior can rise very quickly. Exposure of people or animals to these high temperatures for even a short time can cause death or serious heat-related injuries, including brain damage. Small children are particularly at risk.

## Locks and Security

### REMOTE ENTRY SYSTEM (IF EQUIPPED)

FCC ID: LXP-RX4318	IC: 2298A-RX4318
--------------------	------------------

The integrated keyhead transmitters (IKTs) and intelligent access keys (IA key) comply with part 15 of the FCC rules and with RSS-210 of Industry Canada. Operation is subject to the following two conditions: (1) This device may not cause harmful interference, and (2) This device must accept any interference received, including interference that may cause undesired operation.

**Changes or modifications not expressly approved by the party responsible for compliance could void the user's authority to operate the equipment.**

The typical operating range for your transmitter is approximately 33 feet (10 meters). A decrease in operating range could be caused by:

- weather conditions,
- nearby radio towers,
- structures around the vehicle, or
- other vehicles parked next to your vehicle.

The transmitter allows you to:

- remotely unlock the vehicle doors.
- remotely lock all the vehicle doors.
- remotely open the trunk.
- arm and disarm the perimeter anti-theft system.
- operate the illuminated entry feature.

The remote entry lock/unlock feature operates in any ignition position except when the engine is running and vehicle speed is more than 4 mph (7 km/h).

If there are problems with the remote entry system, make sure to take **ALL integrated keyhead transmitters or intelligent access keys** with you to the authorized dealer in order to aid in troubleshooting the problem.

### Intelligent Access (if equipped)

Your vehicle will allow you to unlock and enter your vehicle without actively using a key or transmitter. You can use the intelligent access feature at the driver door, passenger front door or at the trunk. You can activate the intelligent access feature as long as you have one of your intelligent access keys within range of the driver door, passenger front door or the trunk.

## Locks and Security

**Activating intelligent access at the front doors:** If your IA key is within 3 feet (1 meter) of the driver's door or passenger front door, you can activate your intelligent access system by pressing the lock button.

To lock/unlock the doors, press the lock button on the handle.

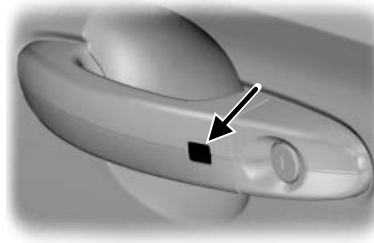

Pressing the driver's door lock button while two-stage unlock is enabled will only unlock the driver's door. Pressing the button with two-stage unlock disabled will unlock all doors. The passenger front door lock button will unlock all doors regardless of two-stage unlock mode. To disable/enable two-stage unlock, refer to *Unlocking the doors/two-stage unlock* later in this section.

**Activating intelligent access at the trunk:** If your IA key is within 3 feet (1 meter) of the trunk, you can activate your intelligent access system by pressing the exterior trunk release button, located above the license plate. The trunk will release and open.

Refer to the *Remote entry system* in this section for more details on how to use the lock, unlock, panic or trunk buttons on the transmitter.



Your intelligent access system uses a radio frequency (RF) signal to communicate with your vehicle and authorize your vehicle to unlock when commanded (either by pressing any keyless entry keypad button, the trunk button, or a button on the transmitter itself). If excessive RF interference is present in the area, or if your vehicle battery is low, it may be necessary to mechanically unlock your door. The mechanical key blade in your IA key can be used to open the driver's door in this situation (refer to *Intelligent access key* in this chapter for more information on the location and use of the mechanical key blade).

A mechanical key is needed for access if the IA key battery or vehicle battery is low.

**Push button start:** Your vehicle is equipped with a push button start system, which allows you to start your vehicle without using a key. To operate the push button start system and start your vehicle, your IA key must be present inside the vehicle, either in the passenger compartment or in the trunk. Refer to *Push button start system* in the *Driving* chapter.



## Locks and Security

### Unlocking the doors/two-stage unlock

1. Press  and release to unlock the driver's door. **Note:** The interior lamps will illuminate and the parking lamps will flash.
2. Press  and release again within three seconds to unlock all the doors.

### Two-stage unlock disable

Disabling two-stage unlock allows all vehicle doors to unlock simultaneously.

Two-stage unlocking may be disabled or re-enabled by simultaneously pressing the  and  controls on the transmitter for three seconds. The park lamps will illuminate twice to indicate that two-stage unlock was enabled or disabled.

### Locking the doors

- Press  and release to lock all the doors. If all doors are closed the turn signal lamps will flash twice.

### Opening the luggage compartment

Press twice (within 3 seconds) to open the luggage compartment.



**Note:** This feature will not operate when the engine is running and vehicle speed is more than 4 mph (7 km/h).

Ensure that the trunk is closed and latched before driving your vehicle. Failure to properly latch the trunk may cause objects to fall out or block the driver's rear view.

### Replacing the battery

The remote entry transmitter uses one coin type three-volt lithium battery CR2032 or equivalent.

To replace the battery:

#### Integrated Keyhead Transmitter (IKT)

1. Carefully insert a flat object (e.g. a screwdriver) into the recess on the back of the key and remove the key blade.

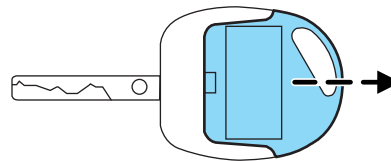

## Locks and Security

2. Release the retaining clips with a flat object and separate the two halves of the transmitter.

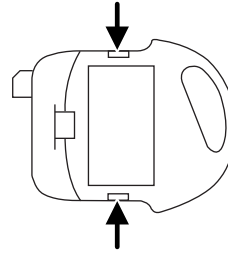

3. Carefully pry out the battery with a flat object. Be careful not to touch the battery contacts or the printed circuit board with the flat object.

**Note:** Please refer to local regulations when disposing of transmitter batteries.

4. Insert the new battery with the + facing upwards.

5. Snap the two halves of the transmitter back together.

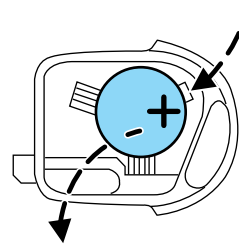

### Intelligent Access key (IA key)

1. Press and hold the push buttons on the edges of the transmitter to release the cover. Carefully remove the cover.

2. Remove the key blade.

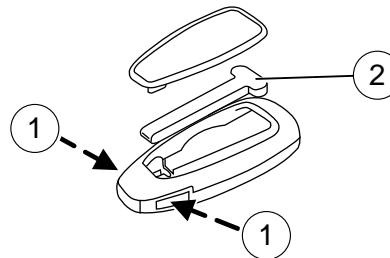

## Locks and Security

3. Twist a flat object in the position shown to separate the two halves of the transmitter.

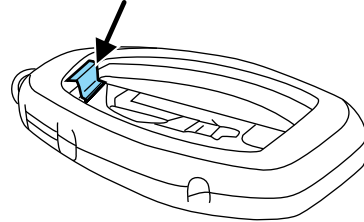

4. Carefully insert a flat object in the position shown to open the transmitter.

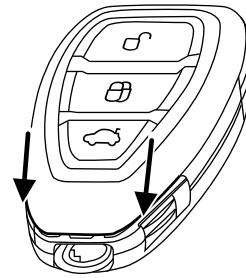

5. Carefully pry out the battery with a flat object.

**Note:** Please refer to local regulations when disposing of transmitter batteries.

6. Install a new battery with the + facing downwards.

7. Assemble the two halves of the transmitter back together.

8. Install the key blade.

### Replacing lost remote entry transmitters—integrated keyhead transmitters (IKTs)

If you would like to have your remote entry transmitter reprogrammed because you lost one, or would like to buy additional remote entry transmitters, you can either reprogram them yourself, or take **all remote entry transmitters** to your authorized dealer for reprogramming.

#### Tips:

- You must have two previously programmed coded keys (keys that already operate your vehicle's engine) and the new unprogrammed key(s) readily accessible.
- If two previously programmed coded keys are not available, you must take your vehicle to your authorized dealer to have the spare key(s) programmed.

## Locks and Security

Please read and understand the entire procedure before you begin.

### **Reprogramming remote entry transmitters**

1. Insert the first programmed key into the ignition and turn the key from off to run (maintain the key in run for approximately 3 seconds).
2. Turn the first key to off and remove it from the ignition.
3. Within 10 seconds of turning the key to off, insert a second programmed key into the ignition and turn the key from off to run (maintain the key in run for approximately 3 seconds).
4. Turn the second key to off and remove it from the ignition.
5. Within 10 seconds of turning the second key to off, insert the new, unprogrammed key into the ignition and turn the key from off to run (maintain the key in run for approximately 3 seconds).

If you would like to program additional key(s) (up to a total of 8 keys can be programmed), repeat Steps 1-5 for each additional key.

6. The Securilock® passive anti-theft system portion of the key is now programmed. To program the remote keyless entry functions of the key follow Steps 1-3 below.

**Note:** When programming remote keyless entry functions, you will delete previous programming of all current keys so you must program all the keys you need every time you do the process.

1. Turn the ignition switch from off to run four times in rapid succession (within six seconds), with the fourth turn ending in off. If the program mode is successfully entered, a chime will sound.

**Note:** If no action is taken within 10 seconds after a transmitter has been programmed, the programming sequence ends.

2. Within 10 seconds, press any button on the transmitter to be programmed. A chime will sound to confirm that the transmitter is programmed. Repeat this step for each transmitter.

**Note:** There is NO chime or any other confirmation upon exiting the programming mode.

3. Exiting the programming mode is accomplished if one of the following occurs:

- The ignition is turned to run.
- Ten seconds have passed since entering programming mode or since the last transmitter was programmed.
- The maximum number (eight) of transmitters has been programmed.

## Locks and Security

### Programming spare Intelligent Access Keys (IA keys)

You cannot program spare keys for your IA keys. If you would like to program spare key transmitters, take **all transmitters** to your authorized dealer for reprogramming.

### Illuminated entry

The interior lamps illuminate for 25 seconds when:

- the vehicle is unlocked by any method other than the interior power door lock control.
- a door has been opened or closed.

The lamps will turn off:

- if the ignition is turned on.
- if the vehicle is locked by any method other than the interior power door lock control.
- after 25 seconds of illumination.

### Illuminated exit

The interior lamps and parking lamps will illuminate for 25 seconds when:

- the ignition is turned off.
- an IKT is removed from, or reinserted into, the ignition.
- after 25 seconds of illumination.

The lamps will turn off:

- if the ignition is turned off.
- if the vehicle is locked by any method other than the power door lock control.
- after 25 seconds of illumination.

### SECURILOCK® PASSIVE ANTI-THEFT SYSTEM

**Note:** The SecuriLock® passive anti-theft system is not compatible with non-Ford aftermarket remote start systems. Use of these systems may result in vehicle starting problems and a loss of security protection.



## Locks and Security

**Note:** Large metallic objects, electronic devices that are used to purchase gasoline or similar items, or a second coded key on the same key chain may cause vehicle starting issues. You need to prevent these objects from touching the coded key while starting the engine. These objects will not cause damage to the coded key, but may cause a momentary issue if they are too close to the key when starting the engine. If a problem occurs, turn the ignition off, remove all objects on the key chain away from the coded key and restart the engine.

**Note:** Do not leave a duplicate coded key in the vehicle. Always take your keys and lock all doors when leaving the vehicle.

SecuriLock® passive anti-theft system is an engine immobilization system. This system is designed to help prevent the engine from being started unless a coded key programmed to your vehicle is used. The use of the wrong type of coded key may lead to a “no-start” condition.

Your vehicle comes with two coded keys; additional coded keys may be purchased from and programmed by your authorized dealer.

### Automatic arming

The vehicle is armed immediately after switching the ignition to the off position.

### Anti-theft indicator

The anti-theft indicator is located in the instrument cluster.

- When the ignition is off, the indicator will flash once every two seconds to indicate the SecuriLock® system is functioning as a theft deterrent.
- When the ignition is on, the indicator will glow for three seconds, then turn off, to indicate normal system functionality.



If a problem occurs with the SecuriLock® system, the indicator will flash rapidly or glow steadily when the ignition is in the on position. If this occurs, turn the ignition off then back on to make sure there was no electronic interference with the programmed key. If the vehicle doesn't start, try to start it with the 2nd programmed key and if successful contact your authorized dealership for key replacement. If the indicator still flashes rapidly or glows steadily, and the vehicle will not start, contact your authorized dealer as soon as possible for service.

### Automatic disarming

Switching the ignition to the on position with a **coded key** disarms the vehicle.

## Locks and Security

### Replacement keys

If your keys are lost or stolen and you don't have an extra coded key, you will need to have your vehicle towed to an authorized dealer. The key codes need to be erased from your vehicle and new coded keys will need to be programmed.

Replacing coded keys can be very costly. Store an extra programmed key away from the vehicle in a safe place to help prevent any inconveniences. Please visit an authorized dealer to purchase additional spare or replacement keys.

### PERIMETER ALARM SYSTEM (IF EQUIPPED)

The perimeter anti-theft system will warn you in the event of an unauthorized entry to your vehicle.

If there is any potential perimeter anti-theft problem with your vehicle, ensure **ALL remote entry transmitters** are taken to the authorized dealer to aid in troubleshooting.

### Arming the system

When armed, this system will respond if unauthorized entry is attempted. When unauthorized entry occurs, the system will flash the park/turn lamps and will sound the horn.

The system is ready to arm whenever the key is removed from the ignition. Either of the following actions will prearm the alarm system:

- Press the lock control on the remote entry transmitter.
- Open a door and press the power door lock control to lock all the doors, and then close the door.

### Disarming the system

You can disarm the system by any of the following actions:

- Unlock the doors by pressing the  control on your remote entry transmitter.
- Unlock the doors with a key. Turn the key full travel (toward the front of the vehicle) to ensure the alarm disarms.
- Turn the ignition to the on or start position with a programmed coded ignition key.

Pressing the power door unlock control within the 20 second pre-armed mode will return the vehicle to a disarmed state.

### Triggering the anti-theft system

The armed system will be triggered if any door, trunk or the hood is opened without using the key or the remote entry transmitter.

## Seating and Safety Restraints

### FRONT SEATS

 **WARNING:** Reclining the seatback can cause an occupant to slide under the seat's safety belt, resulting in severe personal injuries in the event of a collision.

 **WARNING:** Do not pile cargo higher than the seatbacks to reduce the risk of injury in a collision or sudden stop.

 **WARNING:** Before returning the seatback to its original position, make sure that cargo or any objects are not trapped behind the seatback. After returning the seatback to its original position, pull on the seatback to ensure that it has fully latched. An unlatched seat may become dangerous in the event of a sudden stop or collision.

 **WARNING:** Never adjust the driver's seat or seatback when the vehicle is moving.

 **WARNING:** Always drive and ride with your seatback upright and the lap belt snug and low across the hips.

### HEAD RESTRAINTS

 **WARNING:** To minimize the risk of neck injury in the event of a crash, the driver and passenger occupants should not sit in and/or operate the vehicle, until the head restraint is placed in its proper position. The driver should never adjust the head restraint while the vehicle is in motion.

 **WARNING:** The adjustable head restraint is a safety device. Whenever possible, it should be installed and properly adjusted when the seat is occupied.

 **WARNING:** Install the head restraint properly to minimize the risk of neck injury in the event of a crash.

## Seating and Safety Restraints

### Front seat head restraints

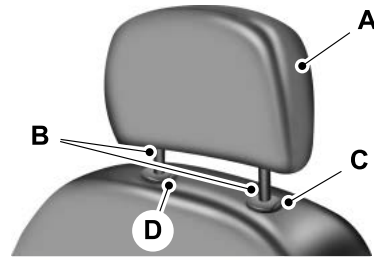

### Rear seat outboard head restraints

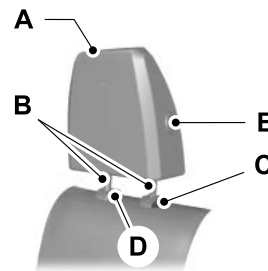

### Rear seat center head restraints

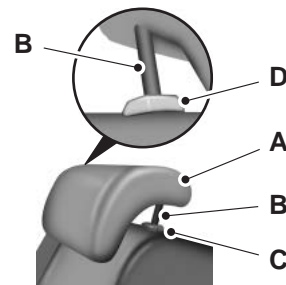

The head restraints consist of:

- A. An energy absorbing head restraint
- B. Two steel stems
- C. Guide sleeve adjust and release button
- D. Guide sleeve unlock and remove button
- E. Fold button

## Seating and Safety Restraints

**Note:** Adjust the seatback to an upright driving position before adjusting any head restraint. Adjust the head restraint so that the top of it is level with the top of your head and as far forward as possible, remaining comfortable. For occupants of extremely tall stature, adjust the head restraint to its highest position.

### Adjusting the Head Restraint

#### Raising the head restraint

Pull up the head restraint.

#### Lowering the head restraint

1. Press and hold button C.
2. Push the head restraint down.

#### Removing the head restraint

1. Pull up the head restraint until it reaches the highest adjustment position.
2. Press and hold buttons C and D.
3. Pull the head restraint up.

#### Installing the head restraint

Align the steel stems into the guide sleeves and push the head restraint down until it locks.

#### Folding the head restraint

1. Press and hold button E.
2. Pull it back up to reset.

#### Adjusting the front manual seat



**WARNING:** Sitting improperly out of position or with the seat back reclined too far can take off weight from the seat cushion and affect the decision of the passenger sensing system, resulting in serious injury or death in a crash. Always sit upright against your seatback, with your feet on the floor.



**WARNING:** To reduce the risk of possible serious injury: Do not hang objects off seat back or stow objects in map pocket (if equipped) when a child is in the front passenger seat. Do not place objects underneath the front passenger seat or between the seat and the center console (if equipped). Check the “passenger airbag off” or “pass airbag off” indicator lamp for proper airbag status. Refer to *Front passenger sensing system* chapter for additional details. Failure to follow these instructions may interfere with the front passenger seat sensing system.

## Seating and Safety Restraints

- **Fore-aft adjustment**

Pull the lever located under the front edge of the seat to move the seat forward or backward.

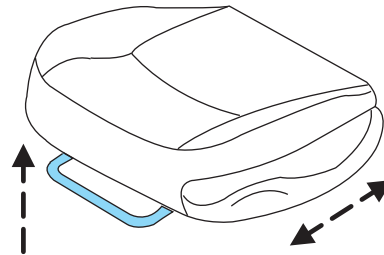

- **Up-down seat adjustment (driver's side only)**

Pull up on the control to raise the seat and push down on the control to lower the seat.

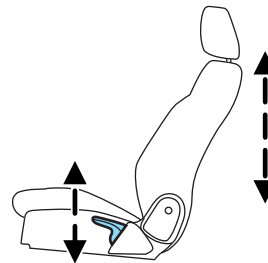

## Seating and Safety Restraints

- **Recline adjustment**

Lift the control to adjust the angle of the seatback.

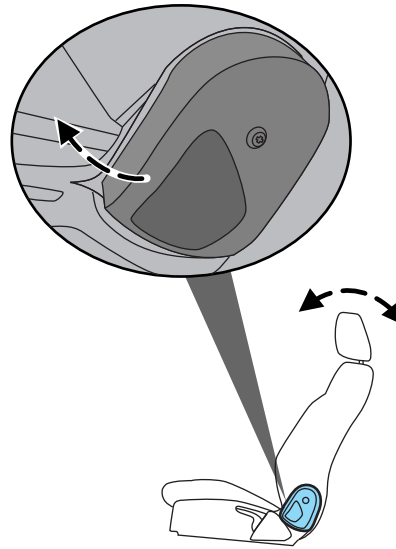

**WARNING:** Reclining the seatback can cause an occupant to slide under the seat's safety belt, resulting in severe personal injuries in the event of a collision.

***Using the armrest (if equipped)***

Move the armrest up or down. You can also move it all the way up to stow it on the side of the seatback.

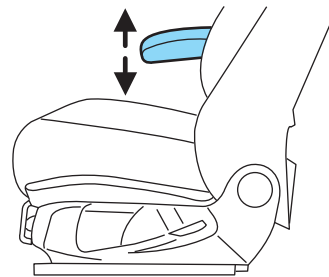

## Seating and Safety Restraints

### Heated seats (if equipped)

 **WARNING:** Persons who are unable to feel pain to the skin because of advanced age, chronic illness, diabetes, spinal cord injury, medication, alcohol use, exhaustion, or other physical conditions, must exercise care when using the seat heater. The seat heater may cause burns even at low temperatures, especially if used for long periods of time. Do not place anything on the seat that insulates against heat, such as a blanket or cushion, because this may cause the seat heater to overheat. Do not puncture the seat with pins, needles, or other pointed objects because this may damage the heating element which may cause the seat heater to overheat. An overheated seat may cause serious personal injury.

**Note:** Do not do the following:

- Place heavy objects on the seat
- Operate the seat heater if water or any other liquid is spilled on the seat. Allow the seat to dry thoroughly.

Your heated seats include both a heated seat cushion and heated seatback.

To operate the heated seats:

- Press the button located on the instrument panel to activate.
- Press again to deactivate.



The heated seats will activate when the ignition is in the on position and the engine is running.

### REAR SEATS

#### Second row head restraints

##### Outboard seat positions

Your vehicle is equipped with second row outboard head restraints that are vertically adjustable.

 **WARNING:** To minimize the risk of neck injury in the event of a crash, the driver and passenger occupants should not sit in and/or operate the vehicle, until the head restraint is placed in its proper position. The driver should never adjust the head restraint while the vehicle is in motion.



## Seating and Safety Restraints

The adjustable outboard head restraints consist of :

- a trimmed energy absorbing foam and structure (1),
- two steel stems (2),
- a guide sleeve adjust release button (3),
- and a guide sleeve unlock/remove button (4).

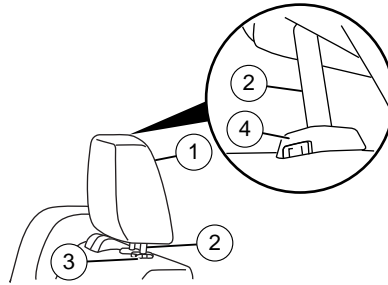

### Center seat position

Your vehicle is equipped with a second row center head restraint that is vertically adjustable.

The adjustable center head restraint consists of :

- a trimmed energy absorbing foam and structure (1),
- two steel stems (2),
- a guide sleeve adjust/release button (3),
- and a guide sleeve unlock/remove button (4).

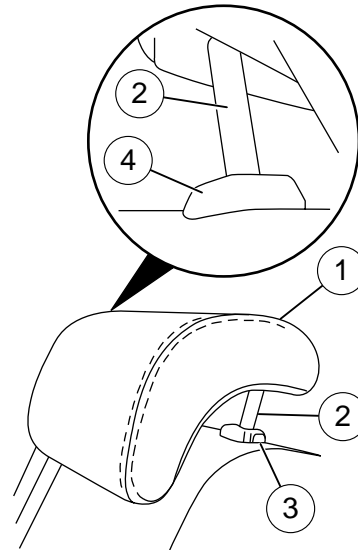

## Seating and Safety Restraints

### To adjust the head restraint, do the following:

1. Pull up on the head restraint to raise it.
2. Lower the head restraint by pressing and holding the guide sleeve adjust button (3) while you push down on the head restraint.

Properly adjust the head restraint so that the top of the head restraint is even with the top of your head and positioned as close as possible to the back of your head. For occupants of extremely tall stature, adjust the head restraint to its full up position.



**WARNING:** The adjustable head restraint is a safety device. Whenever possible, it should be installed and properly adjusted when the seat is occupied.

### To remove the adjustable head restraint, do the following:

1. Pull up on the head restraint until it reaches its highest adjustment position.
2. Simultaneously press and hold both the adjust/release button (3) and the unlock/remove button (4), then pull up on the head restraint.
3. Store the head restraint in a secure location, such as the trunk of the vehicle.

### To reinstall the adjustable head restraint, do the following:

1. Insert the two stems into the guide sleeve collars and push the head restraint down until it locks.
2. Properly adjust the head restraint as mentioned earlier in this section.

### Folding down the rear seat

**Note:** Before lowering the seatbacks, lower, or remove, the outboard head restraints to the lowest position.

One or both rear seatbacks can be folded down to provide additional cargo space.

To lower the seatback(s) from inside the vehicle:

## Seating and Safety Restraints

1. Press the unlock buttons (1) down and hold them there.
2. Push the seatback forward.

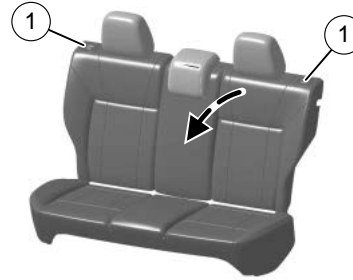

3. Stow the safety belt in the belt stowage clip. This will prevent the safety belt from getting caught in the seat latch.

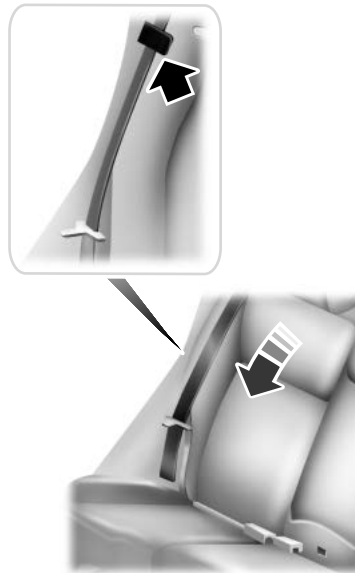

When raising the seatback(s), make sure you hear the seat latch into place.



**WARNING:** Before returning the seatback to its original position, make sure that cargo or any objects are not trapped behind the seatback. Make sure that the safety belt is not laying on the seat latch. After returning the seatback to its original position, pull on the seatback to ensure that it has fully latched. An unlatched seat may become dangerous in the event of a sudden stop or collision.

## Seating and Safety Restraints

### PERSONAL SAFETY SYSTEM™

The Personal Safety System provides an improved overall level of frontal crash protection to front seat occupants and is designed to help further reduce the risk of airbag-related injuries. The system is able to analyze different occupant conditions and crash severity before activating the appropriate safety devices to help better protect a range of occupants in a variety of frontal crash situations.

Your vehicle's Personal Safety System consists of:

- Driver and passenger dual-stage airbag supplemental restraints.
- Front safety belts with pretensioners, energy management retractors, and safety belt usage sensors.
- Driver's seat position sensor.
- Front crash severity sensor.
- Front passenger sensing system.
- "Passenger airbag off" or "pass airbag off" indicator lamp.
- Restraints Control Module (RCM) with impact and safing sensors.
- Restraint system warning light and back-up tone.
- The electrical wiring for the airbags, crash sensor(s), safety belt pretensioners, front safety belt usage sensors, driver seat position sensor, and indicator lights.

### How does the Personal Safety System work?

The Personal Safety System can adapt the deployment strategy of your vehicle's safety devices according to crash severity and conditions. A collection of crash sensors provides information to the Restraints Control Module (RCM). During a crash, the RCM may activate the safety belt pretensioners and/or either none, one, or both stages of the dual-stage airbag supplemental restraints based on crash severity and conditions.

The fact that the pretensioners or airbags did not activate for both front seat occupants in a collision does not mean that something is wrong with the system. Rather, it means the Personal Safety System determined the accident conditions (crash severity, belt usage, etc.) were not appropriate to activate these safety devices. Front airbags are designed to activate only in frontal and near-frontal collisions, not rollovers, side-impacts, or rear-impacts unless the collision causes sufficient longitudinal deceleration.

## Seating and Safety Restraints

### **Driver and passenger dual-stage airbag supplemental restraints**

The dual-stage airbags offer the capability to tailor the level of airbag inflation energy. A lower, less forceful energy level is provided for more common, moderate-severity impacts. A higher energy level is used for the most severe impacts. Refer to *Airbag supplemental restraints (SRS)* section in this chapter.

### **Front crash severity sensor**

The front crash severity sensor enhances the ability to detect the severity of an impact. Positioned up front, it provides valuable information early in the crash event on the severity of the impact. This allows your Personal Safety System to distinguish between different levels of crash severity and modify the deployment strategy of the dual-stage airbags and safety belt pretensioners.

### **Driver's seat position sensor**

The driver's seat position sensor allows your Personal Safety System to tailor the deployment level of the driver dual-stage airbag based on seat position. The system is designed to help protect smaller drivers sitting close to the driver airbag by providing a lower airbag output level.

### **Front passenger sensing system**

For airbags to do their job they must inflate with great force, and this force can pose a potentially deadly risk to occupants that are very close to the airbag when it begins to inflate. For some occupants, like infants in rear-facing child seats, this occurs because they are initially sitting very close to the airbag. For other occupants, this occurs when the occupant is not properly restrained by safety belts or child safety seats and they move forward during pre-crash braking. The most effective way to reduce the risk of unnecessary injuries is to make sure all occupants are properly restrained. Accident statistics suggest that children are much safer when properly restrained in the rear seating positions than in the front.



**WARNING:** Air bags can kill or injure a child in a child seat.

**NEVER** place a rear-facing child seat in front of an active air bag. If you must use a forward-facing child seat in the front seat, move the seat all the way back.



**WARNING:** Always transport children 12 years old and under in a rear seating position and always properly use appropriate child restraints.

## Seating and Safety Restraints

The front passenger sensing system can automatically turn off the passenger front airbag. The system is designed to help protect small (child size) occupants from airbag deployments when they are improperly seated or restrained in the front passenger seat contrary to proper child-seating or restraint usage recommendations. Even with this technology, parents are **STRONGLY** encouraged to always properly restrain children in the rear seat. The sensor also turns off the airbag when the passenger seat is empty to prevent unnecessary replacement of the airbag(s) after a collision.

When the front passenger seat is occupied and the sensing system has turned off the passenger's frontal airbag, the "pass airbag off" indicator will light and stay lit to remind you that the front passenger frontal airbag is off. See *Front passenger sensing system* in the *Airbag supplemental restraints (SRS)* section of this chapter.

### **Front safety belt usage sensors**

The front safety belt usage sensors detect whether or not the driver and front outboard passenger safety belts are fastened. This information allows your Personal Safety System to tailor the airbag deployment and safety belt pretensioner activation depending upon safety belt usage.

### **Front outboard safety belt pretensioners**

The safety belt pretensioners at the front outboard seating positions are designed to tighten the safety belts firmly against the occupant's body during frontal collisions, and in side collisions when the side air curtain system activates. This helps increase the effectiveness of the safety belts. In frontal collisions, the safety belt pretensioners can be activated alone or, if the collision is of sufficient severity, together with the front airbags.

### **Front outboard safety belt energy management retractors**

The front safety belt energy management retractors allow webbing to be pulled out of the retractor in a gradual and controlled manner in response to the occupant's forward momentum. This helps reduce the risk of force-related injuries to the occupant's chest by limiting the load on the occupant.

## Seating and Safety Restraints

### ***Determining if the Personal Safety System is operational***

The Personal Safety System uses a warning light in the instrument cluster or a backup tone to indicate the condition of the system. Refer to the *Warning lights and chimes* section in the *Instrument Cluster* chapter. Routine maintenance of the Personal Safety System is not required.

The Restraints Control Module (RCM) monitors its own internal circuits and the circuits for the airbag supplemental restraints, crash sensor(s), safety belt pretensioners, front safety belt buckle sensors, front passenger sensing system, and the driver seat position sensor. In addition, the RCM also monitors the restraints warning light in the instrument cluster. A difficulty with the system is indicated by one or more of the following.

- The warning light will either flash or stay lit.
- The warning light will not illuminate immediately after ignition is turned on.
- A series of five beeps will be heard. The tone pattern will repeat periodically until the problem and warning light are repaired.

If any of these things happen, even intermittently, have the Personal Safety System serviced at an authorized dealer immediately. Unless serviced, the system may not function properly in the event of a collision.

### **SAFETY BELT SYSTEM**



**WARNING:** Always drive and ride with your seatback upright and the lap belt snug and low across the hips.



**WARNING:** To reduce the risk of injury, make sure children sit where they can be properly restrained.





**WARNING:** Never let a passenger hold a child on his or her lap while the vehicle is moving. The passenger cannot protect the child from injury in a collision.





**WARNING:** All occupants of the vehicle, including the driver, should always properly wear their safety belts, even when an air bag supplemental restraint system (SRS) is provided.

## Seating and Safety Restraints

 **WARNING:** It is extremely dangerous to ride in a cargo area, inside or outside of a vehicle. In a collision, people riding in these areas are more likely to be seriously injured or killed. Do not allow people to ride in any area of your vehicle that is not equipped with seats and safety belts. Be sure everyone in your vehicle is in a seat and using a safety belt properly.

 **WARNING:** In a rollover crash, an unbelted person is significantly more likely to die than a person wearing a seat belt.

 **WARNING:** Each seating position in your vehicle has a specific safety belt assembly which is made up of one buckle and one tongue that are designed to be used as a pair. 1) Use the shoulder belt on the outside shoulder only. Never wear the shoulder belt under the arm. 2) Never swing the safety belt around your neck over the inside shoulder. 3) Never use a single belt for more than one person.

 **WARNING:** When possible, all children 12 years old and under should be properly restrained in a rear seating position.

 **WARNING:** Safety belts and seats can become hot in a vehicle that has been closed up in sunny weather; they could burn a small child. Check seat covers and buckles before you place a child anywhere near them.

 **WARNING:** Front and rear seat occupants, including pregnant women, should wear safety belts for optimum protection in an accident.



## Seating and Safety Restraints

### Combination lap and shoulder belts

The front outboard and rear safety restraints in the vehicle are combination lap and shoulder belts.

1. Insert the belt tongue into the proper buckle (the buckle closest to the direction the tongue is coming from) until you hear a snap and feel it latch. Make sure the tongue is securely fastened in the buckle.

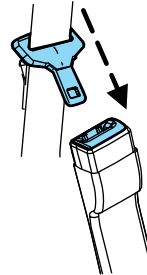

2. To unfasten, press the release button and remove the tongue from the buckle.

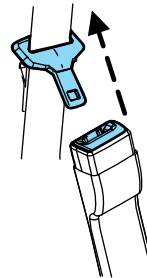

### Restraint of pregnant women



**WARNING:** Always ride and drive with your seatback upright and the safety belt properly fastened. The lap portion of the safety belt should fit snug and be positioned low across the hips. The shoulder portion of the safety belt should be positioned across the chest. Pregnant women should also follow this practice. See figure below.

## Seating and Safety Restraints

Pregnant women should always wear their safety belt. The lap belt portion of a combination lap and shoulder belt should be positioned low across the hips below the belly and worn as tight as comfort will allow. The shoulder belt should be positioned to cross the middle of the shoulder and the center of the chest.

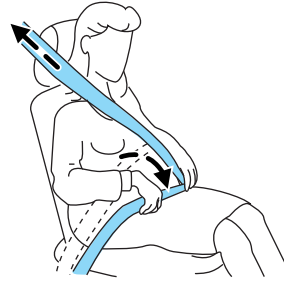

### Safety Belt Locking Modes

All safety restraints in the vehicle are combination lap and shoulder belts. The driver safety belt has the first locking mode and the front outboard passenger and rear seat safety belts have both types of locking modes described as follows:

#### Vehicle sensitive mode

This is the normal retractor mode, which allows free shoulder belt length adjustment to your movements and locking in response to vehicle movement. For example, if the driver brakes suddenly or turns a corner sharply, or the vehicle receives an impact of approximately 5 mph (8 km/h) or more, the combination safety belts will lock to help reduce forward movement of the driver and passengers.

In addition, the retractor is designed to lock if the webbing is pulled out too quickly. If this occurs, let the belt retract slightly and pull webbing out again in a slow and controlled manner.

#### Automatic locking mode

In this mode, the shoulder belt is automatically pre-locked. The belt will still retract to remove any slack in the shoulder belt. The automatic locking mode is not available on the driver safety belt.

#### *When to use the automatic locking mode*

This mode should be used **any time** a child safety seat, except a booster, is installed in passenger front or rear seating positions. Children 12 years old and under should be properly restrained in a rear seating position whenever possible. Refer to *Safety restraints for children* or *Safety seats for children* later in this chapter.

## Seating and Safety Restraints

### ***How to use the automatic locking mode***

1. Buckle the combination lap and shoulder belt.
2. Grasp the shoulder portion and pull downward until the entire belt is pulled out.

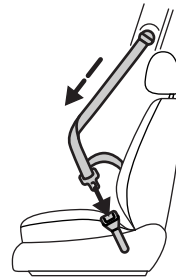

- Allow the belt to retract. As the belt retracts, you will hear a clicking sound. This indicates the safety belt is now in the automatic locking mode.

### **How to disengage the automatic locking mode**

Disconnect the combination lap/shoulder belt and allow it to retract completely to disengage the automatic locking mode and activate the vehicle sensitive (emergency) locking mode.



**WARNING:** After any vehicle collision, the safety belt system at all passenger seating positions must be checked by an authorized dealer to verify that the “automatic locking retractor” feature for child seats is still functioning properly. In addition, all safety belts should be checked for proper function.



**WARNING:** BELT AND RETRACTOR ASSEMBLY MUST BE REPLACED if the safety belt assembly “automatic locking retractor” feature or any other safety belt function is not operating properly when checked by an authorized dealer. Failure to replace the belt and retractor assembly could increase the risk of injury in collisions.

## Seating and Safety Restraints

### Safety belt extension assembly

If the safety belt is too short when fully extended, a safety belt extension assembly can be obtained from an authorized dealer.

Use only extensions manufactured by the same supplier as the safety belt. Manufacturer identification is located at the end of the webbing on the label. Also, use the safety belt extension only if the safety belt is too short for you when fully extended.



**WARNING:** Do not use extensions to change the fit of the shoulder belt across the torso.

### Safety belt height adjustment

Your vehicle has safety belt height adjustments at the front outboard seating positions. Adjust the height of the shoulder belt so the belt rests across the middle of your shoulder.

To adjust the shoulder belt height, pull the button and slide the height adjuster down. Release the button and pull down on the height adjuster to make sure it is locked in place. To adjust the belt upward, slide the adjuster up. Pull down on the height adjuster to make sure it is locked in place.

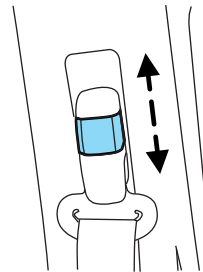

**WARNING:** Position the safety belt height adjusters so that the belt rests across the middle of your shoulder. Failure to adjust the safety belt properly could reduce the effectiveness of the safety belt and increase the risk of injury in a collision.

## Seating and Safety Restraints

### Safety belt warning light and indicator chime

The safety belt warning light illuminates in the instrument cluster and a chime sounds to remind the occupants to fasten their safety belts.

#### Conditions of operation

If...	Then...
The driver's safety belt is not buckled before the ignition switch is turned to the on position...	The safety belt warning light illuminates 1-2 minutes and the warning chime sounds 4-8 seconds.
The driver's safety belt is buckled while the indicator light is illuminated and the warning chime is sounding...	The safety belt warning light and warning chime turn off.
The driver's safety belt is buckled before the ignition switch is turned to the on position...	The safety belt warning light and indicator chime remain off.

### Belt-Minder®

The Belt-Minder® feature is a supplemental warning to the safety belt warning function. This feature provides additional reminders by intermittently sounding a chime and illuminating the safety belt warning light in the instrument cluster when the driver's and front passenger's safety belt is unbuckled.

The Belt-Minder® feature uses information from the front passenger sensing system to determine if a front seat passenger is present and therefore potentially in need of a warning. To avoid activating the Belt-Minder® feature for objects placed in the front passenger seat, warnings will only be given to large front seat occupants as determined by the front passenger sensing system.

Both the driver's and passenger's safety belt usages are monitored and either may activate the Belt-Minder® feature. The warnings are the same for the driver and the front passenger. If the Belt-Minder® warnings have expired (warnings for approximately five minutes) for one occupant (driver or front passenger), the other occupant can still activate the Belt-Minder® feature.

## Seating and Safety Restraints

If...	Then...
The driver's and front passenger's safety belts are buckled before the ignition switch is turned to the on position or less than 1-2 minutes have elapsed since the ignition switch has been turned to on...	The Belt-Minder® feature will not activate.
The driver's or front passenger's safety belt is not buckled when the vehicle has reached at least 6 mph (9.7 km/h) and 1-2 minutes have elapsed since the ignition switch has been turned to on...	The Belt-Minder® feature is activated - the safety belt warning light illuminates and the warning chime sounds for six seconds every 30 seconds, repeating for approximately five minutes or until the safety belts are buckled.
The driver's or front passenger's safety belt becomes unbuckled for approximately one minute while the vehicle is traveling at least 6 mph (9.7 km/h) and more than 1-2 minutes have elapsed since the ignition switch has been turned to on...	The Belt-Minder® feature is activated - the safety belt warning light illuminates and the warning chime sounds for six seconds every 30 seconds, repeating for approximately five minutes or until the safety belts are buckled.

## Seating and Safety Restraints

The following are reasons most often given for not wearing safety belts  
(All statistics based on U.S. data):

Reasons given...	Consider...
“Crashes are rare events”	<b>36700 crashes occur every day.</b> The more we drive, the more we are exposed to “rare” events, even for good drivers. <i>1 in 4 of us will be seriously injured in a crash during our lifetime.</i>
“I’m not going far”	<b>3 of 4</b> fatal crashes occur within <b>25 miles (40 km)</b> of home.
“Belts are uncomfortable”	We design our safety belts to enhance comfort. If you are uncomfortable - try different positions for the safety belt upper anchorage and seatback which should be as upright as possible; this can improve comfort.
“I was in a hurry”	<b>Prime time for an accident.</b> Belt-Minder® reminds us to take a few seconds to buckle up.
“Safety belts don’t work”	<b>Safety belts</b> , when used properly, <b>reduce risk of death</b> to front seat occupants by <b>45% in cars</b> , and by <b>60% in light trucks</b> .
“Traffic is light”	<b>Nearly 1 of 2 deaths occur in single-vehicle crashes</b> , many when no other vehicles are around.
“Belts wrinkle my clothes”	Possibly, but a serious crash can do much more than wrinkle your clothes, particularly if you are unbelted.
“The people I’m with don’t wear belts”	Set the example, teen deaths occur 4 times more often in vehicles with TWO or MORE people. Children and younger brothers/sisters imitate behavior they see.

## Seating and Safety Restraints

Reasons given...	Consider...
"I have an airbag"	Airbags offer greater protection when used with safety belts. Frontal airbags are not designed to inflate in rear and side crashes or rollovers.
"I'd rather be thrown clear"	Not a good idea. <b>People</b> who are <b>ejected are 40 times more likely to DIE</b> . Safety belts help prevent ejection, WE CAN'T "PICK OUR CRASH".



**WARNING:** Do not sit on top of a buckled safety belt or insert a latchplate into the buckle to avoid the Belt-Minder® chime. To do so may adversely affect the performance of the vehicle's airbag system.

### ***Deactivating/Activating the Belt-Minder® Feature (if equipped)***



**WARNING:** While the design allows you to deactivate your Belt-Minder®, this system is designed to improve your chances of being safely belted and surviving an accident. We recommend you leave the Belt-Minder® system activated for yourself and others who may use the vehicle. To reduce the risk of injury, do not deactivate/activate the Belt-Minder® feature while driving the vehicle.

**Note:** The driver and front passenger Belt-Minder® are deactivated/activated independently. When deactivating/activating one seating position, do not buckle the other position as this will terminate the process.

*Read Steps 1 - 4 thoroughly before proceeding with the deactivation/activation programming procedure.*

**Note:** The driver and front passenger Belt-Minder® features must be disabled/enabled separately. Both cannot be disabled/enabled during the same key cycle.



## Seating and Safety Restraints

The driver and front passenger Belt-Minder® features can be deactivated/activated by performing the following procedure:

Before following the procedure, make sure that:

- The parking brake is set.
  - The gearshift is in P (Park) (automatic transmission) and in neutral (manual transmission).
  - The ignition is off.
  - The driver and front passenger safety belts are unbuckled.
1. Turn the ignition on. **DO NOT START THE ENGINE.**
  2. Wait until the safety belt warning light turns off (approximately one minute).
    - Step 3 must be completed within 30 seconds after the safety belt warning light turns off.
  3. For the seating position being disabled, buckle then unbuckle the safety belt three times at a moderate speed, ending in the unbuckled state.
    - After Step 3, the safety belt warning light will be turned on for three seconds.
  4. Within approximately seven seconds of the light turning off, buckle then unbuckle the safety belt.
    - This will disable the Belt-Minder feature for that seating position if it is currently enabled. As confirmation, the safety belt warning light will flash four times per second for three seconds.
    - This will enable the Belt-Minder® feature for that seating position if it is currently disabled. As confirmation, the safety belt warning light will flash four times per second for three seconds, followed by three seconds with the light off, then followed by the safety belt warning light flashing one time per second for three seconds again.

## Seating and Safety Restraints

### AIRBAG SUPPLEMENTAL RESTRAINT SYSTEM (SRS)





The supplemental restraint system is designed to work with the safety belt to help protect the driver and right front passenger from certain upper body injuries.

 **WARNING:** Airbags **DO NOT** inflate slowly or gently, and the risk of injury from a deploying airbag is the greatest close to the trim covering the airbag module.

#### Important SRS precautions

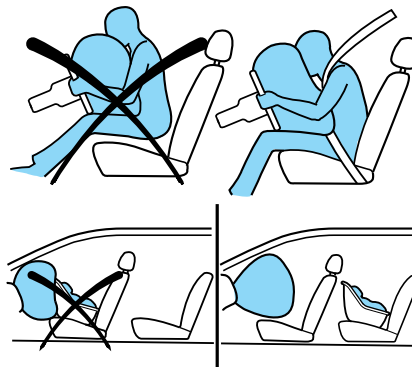
The SRS is designed to work with the safety belt to help protect the driver and right front passenger from certain upper body injuries. Airbags **DO NOT** inflate slowly; there is a risk of injury from a deploying airbag.



 **WARNING:** All occupants of the vehicle, including the driver, should always properly wear their safety belts, even when an air bag supplemental restraint system (SRS) is provided.

## Seating and Safety Restraints



**WARNING:** When possible, all children 12 years old and under should be properly restrained in a rear seating position.



**WARNING:** The National Highway Traffic Safety Administration (NHTSA) recommends a minimum distance of at least 10 inches (25 cm) between an occupant's chest and the driver airbag module.



**WARNING:** Never place your arm over the airbag module as a deploying airbag can result in serious arm fractures or other injuries.

To properly position yourself away from the airbag:

- Move your seat to the rear as far as you can while still reaching the pedals comfortably.
- Recline the seat slightly one or two degrees from the upright position.



**WARNING:** Do not put anything on or over the airbag module. Placing objects on or over the airbag inflation area may cause those objects to be propelled by the airbag into your face and torso causing serious injury.



**WARNING:** Do not attempt to service, repair, or modify the airbag supplemental restraint systems or its fuses. Contact your authorized dealer as soon as possible.

## Seating and Safety Restraints

### Children and airbags

Children must always be properly restrained. Accident statistics suggest that children are safer when properly restrained in the rear seating positions than in the front seating position. Failure to follow these instructions may increase the risk of injury in a collision.

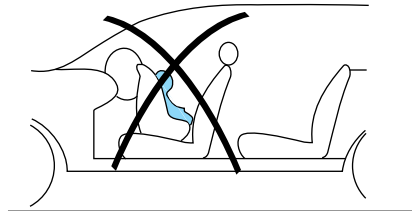

**WARNING:** Airbags can kill or injure a child in a child seat. **NEVER** place a rear-facing child seat in front of an active airbag. If you must use a forward-facing child seat in the front seat, move the seat all the way back.

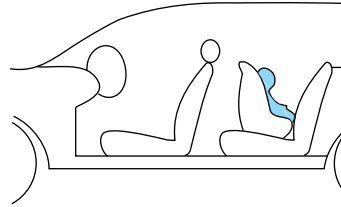

### How does the safety belt pretensioner and airbag supplemental restraint system work?

The safety belt pretensioner and airbag SRS are designed to activate when the vehicle sustains longitudinal deceleration sufficient to cause the sensors to close an electrical circuit that initiates pretensioner activation and airbag inflation.

The fact that the pretensioners and airbags did not activate in a collision does not mean that something is wrong with the system. Rather, it means the forces were not of the type sufficient to cause activation. Front airbags are designed to activate in frontal and near-frontal collisions, not rollover, side-impact, or rear-impacts unless the collision causes sufficient longitudinal deceleration.

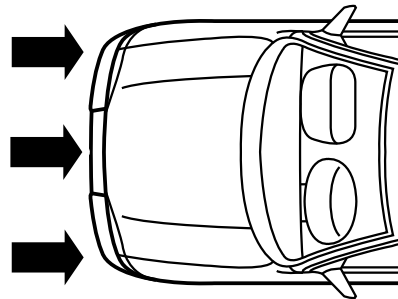

## Seating and Safety Restraints

The airbags inflate and deflate rapidly upon activation. After airbag deployment, it is normal to notice a smoke-like, powdery residue or smell the burnt propellant. This may consist of cornstarch, talcum powder (to lubricate the bag) or sodium compounds (e.g., baking soda) that result from the combustion process that inflates the airbag. Small amounts of sodium hydroxide may be present which may irritate the skin and eyes, but none of the residue is toxic.



While the system is designed to help reduce serious injuries, contact with a deploying airbag may also cause abrasions, swelling or temporary hearing loss. Because airbags must inflate rapidly and with considerable force, there is the risk of death or serious injuries such as fractures, facial and eye injuries or internal injuries, particularly to occupants who are not properly restrained or are otherwise out of position at the time of airbag deployment. Thus, it is extremely important that occupants be properly restrained as far away from the airbag module as possible while maintaining vehicle control.



**WARNING:** Several air bag system components get hot after inflation. Do not touch them after inflation.



**WARNING:** If the air bag has deployed, **the air bag will not function again and must be replaced immediately.** If the air bag is not replaced, the unrepaired area will increase the risk of injury in a collision.

The SRS consists of:

- driver and passenger airbag modules (which include the inflators and airbags)
- seat-mounted side airbags. Refer to *Seat-mounted side airbag system* later in this chapter
- safety belt pretensioners
- one or more impact and safing sensors

## Seating and Safety Restraints

- a readiness light and tone
- and the electrical wiring which connects the components
- Side curtain airbag system. Refer to *Side curtain airbag system* later in this chapter.
- Front passenger sensing system. Refer to *Front passenger sensing system* later in this chapter.
- “Passenger airbag off” or “pass airbag off” indicator lamp. Refer to *Front passenger sensing system* later in this chapter.
- Driver’s side knee airbag module.

The diagnostic module monitors its own internal circuits and the supplemental airbag electrical system wiring (including the impact sensors), the system wiring, the airbag system readiness light, the airbag backup power, the airbag ignitors and safety belt pretensioners.

### Knee airbag system (driver’s side only)

The knee airbag is located under the instrument panel. The system works along with the driver’s front airbag to help reduce injury to the legs. When the driver’s airbag activates in a collision, the knee airbag deploys from under the instrument panel.

As with front and side airbags, it is important to be properly seated and restrained to reduce the risk of death or serious injury.

### Front passenger sensing system

The front passenger sensing system is designed to meet the regulatory requirements of Federal Motor Vehicle Safety Standard (FMVSS) 208 and is designed to disable (will not inflate) the front passenger’s frontal airbag under certain conditions.

The front passenger sensing system works with sensors that are part of the front passenger’s seat and safety belt. The sensors are designed to detect the presence of a properly seated occupant and determine if the front passenger’s frontal airbag should be enabled (may inflate) or disabled (will not inflate).

The front passenger sensing system will disable (will not inflate) the front passenger’s frontal airbag if:

- the front passenger seat is unoccupied, or has small/medium objects in the front seat,
- the system determines that an infant is present in a rear-facing infant seat that is installed according to the manufacturer’s instructions,

## Seating and Safety Restraints

- the system determines that a small child is present in a forward-facing child restraint that is installed according to the manufacturer's instructions,
- the system determines that a small child is present in a booster seat,
- a front passenger takes his/her weight off of the seat for a period of time,
- a child or a small person occupies the front passenger seat.

**Note:** When the passenger airbag off light is illuminated, the passenger (seat mounted) side airbag may be disabled to avoid the risk of airbag deployment injuries.

The front passenger sensing system uses a "passenger airbag off" or "pass airbag off" indicator which will illuminate and stay lit to remind you that the front passenger frontal airbag is disabled. The indicator lamp is located at the bottom central portion of the instrument panel below the Hazard warning indicator and above the climate controls.

**PASS  
AIRBAG  
OFF**

**Note:** The indicator lamp will illuminate for a short period of time when the ignition is turned to the on position to confirm it is functional.

When the front passenger seat is not occupied (empty seat) or in the event that the front passenger frontal airbag is enabled (may inflate), the indicator lamp will be unlit.

The front passenger sensing system is designed to disable (will not inflate) the front passenger's frontal airbag when a rear facing infant seat, a forward-facing child restraint, or a booster seat is detected.

- When the front passenger sensing system disables (will not inflate) the front passenger frontal airbag, the indicator lamp will illuminate and stay lit to remind you that the front passenger frontal airbag is disabled.
- If the child restraint has been installed and the indicator lamp is not lit, then turn the vehicle off, remove the child restraint from the vehicle and reinstall the restraint following the child restraint manufacturer's instructions.

The front passenger sensing system is designed to enable (may inflate) the front passenger's frontal airbag anytime the system senses that a person of adult size is sitting properly in the front passenger seat.

- When the front passenger sensing system enables the front passenger frontal airbag (may inflate), the indicator will be unlit and stay unlit.

## Seating and Safety Restraints

If a person of adult size is sitting in the front passenger's seat, but the "passenger airbag off" or "pass airbag off" indicator lamp is lit, it is possible that the person isn't sitting properly in the seat. If this happens:

- Turn the vehicle off and ask the person to place the seatback in the full upright position.
- Have the person sit upright in the seat, centered on the seat cushion, with the person's legs comfortably extended.
- Restart the vehicle and have the person remain in this position for about two minutes. This will allow the system to detect that person and enable the passenger's frontal airbag.
- If the indicator lamp remains lit even after this, the person should be advised to ride in the rear seat.

Occupant	Pass Airbag Off Indicator Lamp	Passenger Airbag
Empty seat	Unlit	Disabled
Small child in child safety seat or booster	Lit	Disabled
Small child with safety belt buckled or unbuckled	Lit	Disabled
Adult	Unlit	Enabled



**WARNING:** Even with Advanced Restraints Systems, children 12 and under should be properly restrained in a rear seating position.

After all occupants have adjusted their seats and put on safety belts, it's very important that they continue to sit properly. A properly seated occupant sits upright, leaning against the seat back, and centered on the seat cushion, with their feet comfortably extended on the floor. Sitting improperly can increase the chance of injury in a crash event. For example, if an occupant slouches, lies down, turns sideways, sits forward, leans forward or sideways, or puts one or both feet up, the chance of injury during a crash is greatly increased.



**WARNING:** Sitting improperly out of position or with the seat back reclined too far can take off weight from the seat cushion and affect the decision of the front passenger sensing system, resulting in serious injury or death in a crash. Always sit upright against your seatback, with your feet on the floor.



## Seating and Safety Restraints

The front passenger sensing system may detect small or medium objects placed on the seat cushion. For most objects that are in the front passenger seat, the passenger airbag will be disabled. Even though the passenger airbag is disabled, the "pass airbag off" lamp may or may not be illuminated according to the table below.

<b>Objects</b>	<b>Pass Airbag Off Indicator Lamp</b>	<b>Passenger Airbag</b>
Small (i.e. three-ring binder, small purse, bottled water)	Unlit	Disabled
Medium (i.e. heavy briefcase, fully packed luggage)	Lit	Disabled
Empty seat, or small to medium object with safety belt buckled	Lit	Disabled

If you think that the status of the passenger airbag off indicator lamp is incorrect, check for the following:

- Objects lodged underneath the seat
- Objects between the seat cushion and the center console (if equipped)
- Objects hanging off the seat back
- Objects stowed in the seatback map pocket (if equipped)
- Objects placed on the occupant's lap
- Cargo interference with the seat
- Other passengers pushing or pulling on the seat
- Rear passenger feet and knees resting or pushing on the seat

The conditions listed above may cause the weight of a properly seated occupant to be incorrectly interpreted by the passenger sensing system. The person in the front passenger seat may appear heavier or lighter due to the conditions described in the list above.

## Seating and Safety Restraints



**WARNING:** To reduce the risk of possible serious injury: Do not stow objects in seat back map pocket (if equipped) or hang objects off seat back if a child is in the front passenger seat. Do not place objects underneath the front passenger seat or between the seat and the center console (if equipped). Check the “passenger airbag off” or “pass airbag off” indicator lamp for proper airbag Status. Failure to follow these instructions may interfere with the passenger seat sensing system.

In case there is a problem with the front passenger sensing system, the airbag readiness lamp in the instrument cluster will stay lit.



### **If the airbag readiness lamp is lit, do the following:**

The driver and/or adult passengers should check for any objects that may be lodged underneath the front passenger seat or cargo interfering with the seat.

If objects are lodged and/or cargo is interfering with the seat; please take the following steps to remove the obstruction:

- Pull the vehicle over.
- Turn the vehicle off.
- Driver and/or adult passengers should check for any objects lodged underneath the front passenger seat or cargo interfering with the seat.
- Remove the obstruction(s) (if found).
- Restart the vehicle.
- Wait at least two minutes and verify that the airbag readiness lamp is no longer illuminated
- If the airbag readiness lamp remains illuminated, this may or may/not be a problem due to the front passenger sensing system.

DO NOT attempt to repair or service the system; take your vehicle immediately to an authorized dealer.

If it is necessary to modify an advanced front airbag system to accommodate a person with disabilities, contact the Ford Customer Relationship Center at the phone number shown in the *Customer Assistance* section of this owner's guide.

## Seating and Safety Restraints



**WARNING:** Any alteration/modification to the front passenger seat may affect the performance of the front passenger sensing system.

### **Determining if the system is operational**

The supplemental restraint system uses a warning indicator light in the instrument cluster or a backup tone to indicate the condition of the system. Refer to the *Warning lights and chimes* section in the *Instrument Cluster* chapter. Routine maintenance of the airbag is not required.

A difficulty with the system is indicated by one or more of the following:

- The readiness light (same light for front and side airbag system) will either flash or stay lit.
- The readiness light will not illuminate immediately after ignition is turned on.
- A series of five beeps will be heard. The tone pattern will repeat periodically until the problem and/or light are repaired.



If any of these things happen, even intermittently, have the supplemental restraint system serviced at an authorized dealer immediately. Unless serviced, the system may not function properly in the event of a collision.

### **Seat-mounted side airbag system**



**WARNING:** Do not place objects or mount equipment on or near the airbag cover on the side of the seatbacks of the front seats or in front seat areas that may come into contact with a deploying airbag. Failure to follow these instructions may increase the risk of personal injury in the event of a collision.





**WARNING:** Do not use accessory seat covers. The use of accessory seat covers may prevent the deployment of the side airbags and increase the risk of injury in an accident.



**WARNING:** Do not lean your head on the door. The side airbag could injure you as it deploys from the side of the seatback.

## Seating and Safety Restraints

 **WARNING:** Do not attempt to service, repair, or modify the airbag SRS, its fuses or the seat cover on a seat containing an airbag. Contact your authorized dealer as soon as possible.

 **WARNING:** All occupants of the vehicle should always wear their safety belts even when an airbag SRS is provided.

### ***How does the side airbag system work?***

The design and development of the side airbag system included recommended testing procedures that were developed by a group of automotive safety experts known as the Side Airbag Technical Working Group. These recommended testing procedures help reduce the risk of injuries related to the deployment of side airbags.

The side airbag system consists of the following:

- An inflatable bag (airbag) with an inflator concealed behind the outboard bolster of the driver and front passenger seatbacks.
- A special seat cover designed to allow airbag deployment.
- The same warning light, electronic control and diagnostic unit as used for the front airbags.
- Crash sensors located on the front doors and C pillars (one sensor on each pillar on each side of the vehicle).

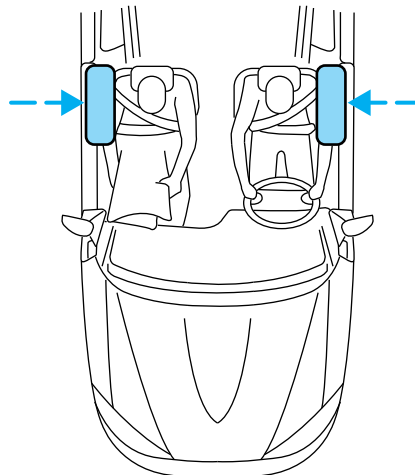

Side airbags, in combination with safety belts, can help reduce the risk of severe injuries in the event of a significant side impact collision.

The side airbags are fitted on the outboard side of the seatbacks of the front seats. In certain lateral collisions, the airbag on the side affected by the collision will be inflated. The airbag was designed to inflate between the door panel and occupant to further enhance the protection provided occupants in side impact collisions.

## Seating and Safety Restraints

The airbag SRS is designed to activate when the vehicle sustains lateral deceleration sufficient to cause the sensors to close an electrical circuit that initiates airbag inflation.

The fact that the airbags did not inflate in a collision does not mean that something is wrong with the system. Rather, it means the forces were not of the type sufficient to cause activation. Side airbags are designed to inflate in side-impact collisions, not roll-over, rear-impact, frontal or near-frontal collisions, unless the collision causes sufficient lateral deceleration.



**WARNING:** Several air bag system components get hot after inflation. Do not touch them after inflation.



**WARNING:** If the side airbag has deployed, **the airbag will not function again. The side airbag system (including the seat) must be inspected and serviced by an authorized dealer.** If the airbag is not replaced, the unrepaired area will increase the risk of injury in a collision.

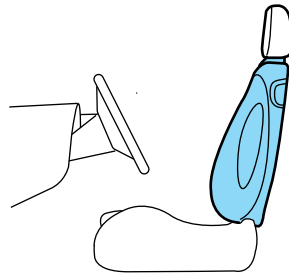

## Seating and Safety Restraints

### Side-curtain airbag system

 **WARNING:** Do not place objects or mount equipment on or near the headliner at the siderail that may come into contact with a deploying side air curtain. Failure to follow these instructions may increase the risk of personal injury in the event of a collision.

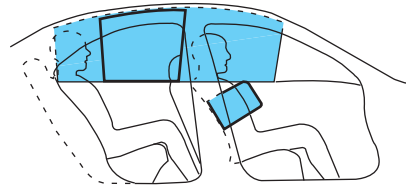

 **WARNING:** Do not place objects or mount equipment on or near the side air curtain cover.

 **WARNING:** Do not lean your head on the door. The side air curtain could injure you as it deploys from the headliner.

 **WARNING:** Do not attempt to service, repair, or modify the side air curtain system, its fuses, the A, B, or C pillar trim, or the headliner on a vehicle containing a side air curtain. See your authorized dealer.

 **WARNING:** All occupants of the vehicle, including the driver, should always wear their safety belts even when an inflatable curtain is provided.

 **WARNING:** To reduce the risk of injury, do not obstruct or place objects in the deployment zone of the inflatable curtain.

## Seating and Safety Restraints

### ***How does the side air curtain system work?***

The design and development of the side air curtain system included recommended testing procedures that were developed by a group of automotive safety experts known as the Side Airbag Technical Working Group. These recommended testing procedures help reduce the risk of injuries related to the deployment of side airbags (including side air curtain systems).

The side air curtain system consists of the following:

- An inflatable curtain with a gas generator concealed behind the headliner and above the doors.
- The headliner will flex to open above the side doors to allow air curtain deployment.
- The same warning light, electronic control and diagnostic unit as used for the front airbags.
- Two pressure sensors located in the front doors.
- Crash sensors located on the front doors and C pillars (one sensor on each pillar on each side of the vehicle).

Side air curtains and side airbags, in combination with safety belts, can help reduce the risk of severe injuries in the event of a significant side impact collision.

Children 12 years old and under should always be properly restrained in the rear seats. The side air curtain will not interfere with children restrained using a properly installed child or booster seat because it is designed to inflate downward from the headliner above the doors along the side window openings.

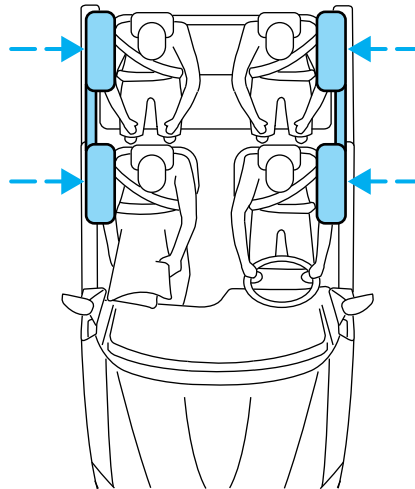

## Seating and Safety Restraints

The side air curtains are mounted to the sheet metal above the first and second row seats. In certain lateral collisions, the air curtain and seat-mounted side airbag on the side affected by the collision will be inflated, except that the passenger sensing system will deactivate the passenger seat-mounted side airbag if it detects an empty unbuckled passenger seat. The air curtain was designed to inflate between the side window area and occupant to further enhance the head protection provided to occupants in side impact collisions. The seat-mounted side airbag was designed to inflate between the door panel and occupant to further enhance the protection provided occupants in side impact collisions.

The side air curtain system SRS is designed to activate when the vehicle sustains lateral deceleration sufficient to cause the sensors to close an electrical circuit that initiates air curtain and seat-mounted side airbag inflation.

The fact that the side air curtain and seat-mounted side airbag did not inflate in a collision does not mean that something is wrong with the system. Rather, it means the forces were not of the type sufficient to cause activation. The side air curtain system is designed to inflate in side impact collisions, not roll-over, rear impact, frontal or near-frontal collisions, unless the collision causes sufficient lateral deceleration.



**WARNING:** Several air bag system components get hot after inflation. Do not touch them after inflation.



**WARNING:** If the side air curtain has deployed, **the air curtain will not function again. The side air curtain system (including the A, B and C pillar trim and headliner) must be inspected and serviced by an authorized dealer.** If the air curtain is not replaced, the unrepaired area will increase the risk of injury in a collision.

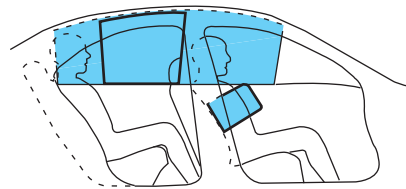



## Seating and Safety Restraints

### ***Determining if the system is operational***

The SRS uses a readiness light in the instrument cluster or a tone to indicate the condition of the system. Refer to *Warning lights and chimes* in the *Instrument Cluster* chapter. Routine maintenance of the side airbag is not required.

A difficulty with the system is indicated by one or more of the following:

- The readiness light (same light as for front airbag system) will either flash or stay lit.
- The readiness light will not illuminate immediately after ignition is turned on.
- A series of five beeps will be heard. The tone pattern will repeat periodically until the problem and/or light are repaired.

If any of these things happen, even intermittently, have the SRS serviced at your authorized dealer immediately. Unless serviced, the system may not function properly in the event of a collision.

### **SOS Post-Crash Alert System™**

The system flashes the turn signal lamps and sounds the horn (intermittently) in the event of a serious impact that deploys an airbag (front, side, side curtain or Safety Canopy®) or the safety belt pretensioners.

The horn and lamps will turn off when:

- the hazard control button is pressed, or
- the vehicle runs out of power.

### **Disposal of airbags and airbag equipped vehicles (including pretensioners)**

Contact your authorized dealer as soon as possible. Airbags MUST BE disposed of by qualified personnel.

## Seating and Safety Restraints

### SAFETY RESTRAINTS FOR CHILDREN

See the following sections for directions on how to properly use safety restraints for children. Also see *Airbag supplemental restraint system (SRS)* in this chapter for special instructions about using airbags.

#### Important child restraint precautions



**WARNING:** Always make sure your child is secured properly in a device that is appropriate for their height, age and weight. Child safety restraints must be purchased separately from the vehicle. Failure to follow these instructions and guidelines may result in an increased risk of serious injury or death to your child.



**WARNING:** All children are shaped differently. The Recommendations for Safety Restraints are based on probable child height, age and weight thresholds from NHTSA and other safety organizations or are the minimum requirements of law. Ford recommends checking with a NHTSA Certified Child Passenger Safety Technician (CPST) and consult your pediatrician to make sure your child seat is appropriate for your child, and is compatible with and properly installed in the vehicle. To locate a child seat fitting station and CPST contact the NHTSA toll free at 1-888-327-4236 or on the internet at <http://www.nhtsa.dot.gov>. In Canada, check with your local St. John Ambulance office for referral to a CPST or for further information, contact your provincial ministry of transportation, your local St. John Ambulance office at <http://www.sfa.ca>, or Transport Canada at 1-800-333-0371 (<http://www.tc.gc.ca>). Failure to properly restrain children in safety seats made especially for their height, age, and weight may result in an increased risk of serious injury or death to your child.

## Seating and Safety Restraints

<b>Recommendations for Safety Restraints for Children</b>		
	<b>Child size, height, weight, or age</b>	<b>Recommended restraint type</b>
Infants or toddlers	Children weighing 40 lb (18 kg) or less (generally age four or younger)	Use a child safety seat (sometimes called an infant carrier, convertible seat, or toddler seat).
Small children	Children who have outgrown or no longer properly fit in a child safety seat (generally children who are less than 4 feet 9 inches (1.45 meters) tall, are greater than age four (4) and less than age twelve (12), and between 40 lb (18 kg) and 80 lb (36 kg) and upward to 100 lb (45 kg) if recommended by your child restraint manufacturer)	Use a belt-positioning booster seat.
Larger children	Children who have outgrown or no longer properly fit in a belt-positioning booster seat (generally children who are at least 4 feet 9 inches (1.45 meters) tall or greater than 80 lb (36 kg) or 100 lb (45 kg) if recommended by child restraint manufacturer)	Use a vehicle safety belt having the lap belt snug and low across the hips, shoulder belt centered across the shoulder and chest, and seatback upright.

- You are required by law to properly use safety seats for infants and toddlers in the U.S. and Canada.
- Many states and provinces require that small children use approved booster seats until they reach age eight, a height of 4 ft 9 in. (1.45 meters) tall, or 80 lb (36 kg). Check your local and state or provincial laws for specific requirements regarding the safety of children in your vehicle.
- When possible, always properly restrain children twelve (12) years of age and under in a rear seating position of your vehicle. Accident statistics suggest that children are safer when properly restrained in the rear seating positions than in a front seating position.

<https://www.MyCarManual.com>

## Seating and Safety Restraints

### Recommendations for attaching child safety restraints for children

Restraint Type	Child Weight	Use any attachment method as indicated below by "X"				
		LATCH (lower anchors and top tether anchor)	LATCH (lower anchors only)	Safety belt and top tether anchor	Safety belt and LATCH (lower anchors and top tether anchor)	Safety belt only
Rear facing child seat	Up to 48 lb (21 kg)		X			X
Forward facing child seat	Up to 48 lb (21 kg)	X		X	X	
Forward facing child seat	Over 48 lb (21 kg)			X	X	

 **WARNING:** Airbags can kill or injure a child in a child seat. NEVER place a rear-facing child seat in front of an active airbag. If you must use a forward-facing child seat in the front seat, move the vehicle seat all the way back. When possible, all children age 12 and under should be properly restrained in a rear seating position. If all children cannot be seated and restrained properly in a rear seating position, properly restrain the largest child in the front seat.

 **WARNING:** Always carefully follow the instructions and warnings provided by the manufacturer of any child restraint to determine if the restraint device is appropriate for your child's size, height, weight, or age. Follow the child restraint manufacturer's instructions and warnings provided for installation and use in conjunction with the instructions and warnings provided by the vehicle manufacturer. A safety seat that is improperly installed or utilized, is inappropriate for your child's height, age, or weight or does not properly fit the child may increase the risk of serious injury or death.

## Seating and Safety Restraints

 **WARNING:** Never let a passenger hold a child on his or her lap while the vehicle is moving. The passenger cannot protect the child from injury in a collision, which may result in serious injury or death.

 **WARNING:** Never use pillows, books, or towels to boost a child. They can slide around and increase the likelihood of injury or death in a collision.

 **WARNING:** Always restrain an unoccupied child seat or booster seat. These objects may become projectiles in a collision or sudden stop, which may increase the risk of serious injury.

 **WARNING:** Never place, or allow a child to place, the shoulder belt under a child's arm or behind the back because it reduces the protection for the upper part of the body and may increase the risk of injury or death in a collision.

 **WARNING:** Do not leave children, unreliable adults, or pets unattended in your vehicle.

### Transporting children

Always make sure your child is secured properly in a device that is appropriate for their age, height and weight. All children are shaped differently. The child height, age and weight thresholds provided are recommendations or the minimum requirements of law. The National Highway Traffic Safety Administration (NHTSA) provides education and training to ensure that all children ages 0 to 16 are properly restrained in the correct restraint system. Ford recommends checking with a NHTSA Certified Child Passenger Safety Technician (CPST) and your pediatrician to make sure your seat is appropriate for your child and properly installed in the vehicle. To locate a child seat fitting station and CPST contact the NHTSA toll free at **1-888-327-4236** or on the internet at <http://www.nhtsa.dot.gov>. In Canada, check with your local St. John Ambulance office for referral to a CPST or for further information, contact your provincial ministry of transportation, your local St. John Ambulance office at <http://www.sfa.ca>, or Transport Canada at 1-800-333-0371 (<http://www.tc.gc.ca>).

## Seating and Safety Restraints

Follow all the safety restraint and airbag precautions that apply to adult passengers in your vehicle.

If the child is the proper height, age, and weight (as specified by your child safety seat or booster manufacturer), fits the restraint and can be restrained properly, then restrain the child in the child safety seat or with the belt-positioning booster. Remember that child seats and belt-positioning boosters vary and may be designed to fit children of different heights, ages and weights. Children who are too large for child safety seats or belt-positioning boosters (as specified by your child safety seat manufacturer) should always properly wear safety belts.

### SAFETY SEATS FOR CHILDREN

#### Infant and/or toddler seats

Use a safety seat that is recommended for the size and weight of the child.

When installing a child safety seat:

- Review and follow the information presented in the *Airbag supplemental restraint system (SRS)* section in this chapter.
- Carefully follow all of the manufacturer's instructions included with the safety seat you put in your vehicle. If you do not install and use the safety seat properly, the child may be injured in a sudden stop or collision.



Airbags can kill or injure a child in a child seat. NEVER place a rear-facing child seat in front of an active airbag. If you must use a forward-facing child seat in the front seat, move the vehicle seat all the way back.

Children 12 and under should be properly restrained in a rear seating position whenever possible. If all children cannot be seated and restrained properly in a rear seating position, properly restrain the largest child in the front seat.

If needed, when installing some high-back child restraints, the head restraints of the second row seating positions can be removed.

To remove the head restraint(s), see *Second row head restraints* under *Rear seats* in this chapter for more information.

## Seating and Safety Restraints



**WARNING:** If the head restraint has been removed from a seating position to accommodate a high-back child restraint, the head restraint must be re-installed prior to use of the seat by any other occupant in order to reduce the risk of personal injury in the event of a collision.

### Installing child safety seats with combination lap and shoulder belts

Check to make sure the child seat is properly secured before each use. Children 12 and under should be properly restrained in a rear seating position whenever possible. If all children cannot be seated and restrained properly in a rear seating position, properly restrain the largest child in the front seat.

When installing a child safety seat with combination lap/shoulder belts:

- Use the correct safety belt buckle for that seating position.
- Insert the belt tongue into the proper buckle until you hear a snap and feel it latch. Make sure the tongue is securely fastened in the buckle.
- Keep the buckle release button pointing up and away from the safety seat, with the tongue between the child seat and the release button, to prevent accidental unbuckling.
- Place vehicle seat back in upright position.
- Put the safety belt in the automatic locking mode. Refer to Step 5 below. This vehicle does not require the use of a locking clip.



**WARNING:** Depending on where you secure a child restraint, and depending on the child restraint design, you may block access to certain safety belt buckle assemblies and/or LATCH lower anchors, rendering those features potentially unusable. To avoid risk of injury, occupants should only use seating positions where they are able to be properly restrained.

## Seating and Safety Restraints

Perform the following steps when installing the child seat with combination lap/shoulder belts:

**Note:** Although the child seat illustrated is a forward facing child seat, the steps are the same for installing a rear facing child seat.

1. Position the child safety seat in a seat with a combination lap and shoulder belt.

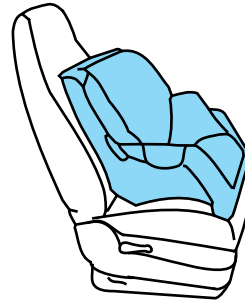

2. Pull down on the shoulder belt and then grasp the shoulder belt and lap belt together.

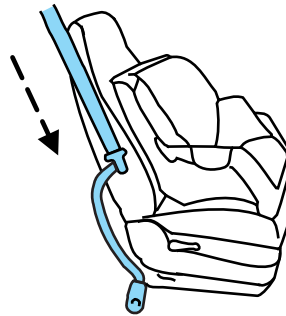

3. While holding the shoulder and lap belt portions together, route the tongue through the child seat according to the child seat manufacturer's instructions. Be sure the belt webbing is not twisted.

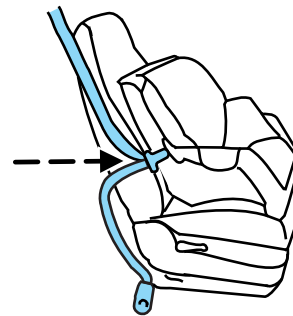



## Seating and Safety Restraints

4. Insert the belt tongue into the proper buckle (the buckle closest to the direction the tongue is coming from) for that seating position until you hear a snap and feel the latch engage. Make sure the tongue is latched securely by pulling on it.

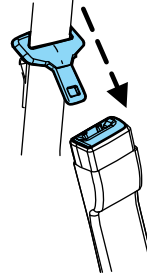

5. To put the retractor in the automatic locking mode, grasp the shoulder portion of the belt and pull downward until all of the belt is pulled out.

**Note:** The automatic locking mode is available on the front passenger and rear seats. This vehicle does not require the use of a locking clip.

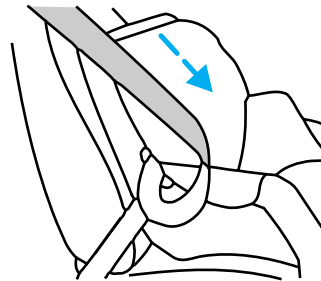

6. Allow the belt to retract to remove slack. The belt will click as it retracts to indicate it is in the automatic locking mode.

7. Try to pull the belt out of the retractor to make sure the retractor is in the automatic locking mode (you should not be able to pull more belt out). If the retractor is not locked, unbuckle the belt and repeat Steps 5 and 6.

8. Remove remaining slack from the belt. Force the seat down with extra weight, e.g., by pressing down or kneeling on the child restraint while pulling up on the shoulder belt in order to force slack from the belt. This is necessary to remove the remaining slack that will exist once the additional weight of the child is added to the child restraint. It also helps to achieve the proper snugness of the child seat to the vehicle. Sometimes, a slight lean towards the buckle will additionally help to remove remaining slack from the belt.

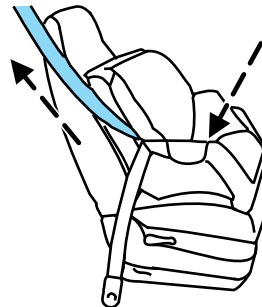

## Seating and Safety Restraints

9. Attach the tether strap (if the child seat is equipped). Refer to *Attaching child safety seats with tether straps* later in this chapter.

10. Before placing the child in the seat, forcibly move the seat forward and back to make sure the seat is securely held in place. To check this, grab the seat at the belt path and attempt to move it side to side and forward and back. There should be no more than 1 inch (2.5 cm) of movement for proper installation.

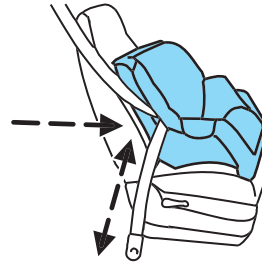

11. Ford recommends checking with a NHTSA Certified Child Passenger Safety Technician (CPST) to make certain the child restraint is properly installed. In Canada, check with your local St. John Ambulance office for referral to a CPST.

### Attaching child safety seats with Lower Anchor and Tethers for Children (LATCH) attachments

The LATCH system is composed of three vehicle anchor points: two (2) lower anchors located where the vehicle seat back and seat cushion meet (called the “seat bight”) and one (1) top tether anchor located behind that seating position.

LATCH compatible child safety seats have two rigid or webbing mounted attachments that connect to the two lower anchors at the LATCH equipped seating positions in your vehicle. This type of attachment method eliminates the need to use safety belts to attach the child seat, however the safety belt can still be used to attach the child seat. For forward-facing child seats, the top tether strap must also be attached to the proper top tether anchor, if a top tether strap has been provided with your child seat. Ford Motor Company recommends the use of a child safety seat having a top tether strap. See *Attaching child safety seats with tether straps* and *Recommendations for attaching safety restraints for children* in this chapter for more information.

## Seating and Safety Restraints

Your vehicle has LATCH lower anchors for child seat installation at the seating positions marked with the child seat symbol.

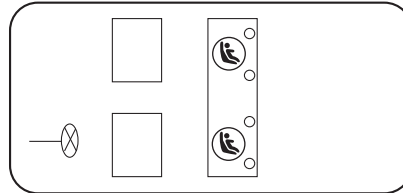

The LATCH anchors are located at the rear section of the rear seat between the cushion and seatback. Follow the child seat manufacturer's instructions to properly install a child seat with LATCH attachments.

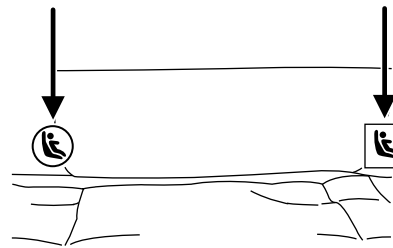

Follow the instructions on attaching child safety seats with tether straps. Refer to *Attaching child safety seats with tether straps* later in this chapter.

Attach LATCH lower attachments of the child seat only to the anchors shown.

**!** **WARNING:** Never attach two child safety seats to the same anchor. In a crash, one anchor may not be strong enough to hold two child safety seat attachments and may break, causing serious injury or death.

**!** **WARNING:** Depending on where you secure a child restraint, and depending on the child restraint design, you may block access to certain safety belt buckle assemblies and/or LATCH lower anchors, rendering those features potentially unusable. To avoid risk of injury, occupants should only use seating positions where they are able to be properly restrained.

## Seating and Safety Restraints

### ***Use of inboard lower anchors from the outboard seating positions (center seating use)***

The lower anchors at the center of the second row rear seat are spaced 390 mm (15 inches) apart. The standardized spacing for LATCH lower anchors is 280 mm (11 inches) center to center. A child seat with rigid LATCH attachments cannot be installed at the center seating position. LATCH compatible child seats (with attachments on belt webbing) can only be used at this seating position provided that the child seat manufacturer's instructions permit use with the anchor spacing stated. Do not attach a child seat to any lower anchor if an adjacent child seat is attached to that anchor.



**WARNING:** The standardized spacing for LATCH lower anchors is 280 mm (11 inches) center to center. Do not use LATCH lower anchors for the center seating position unless the child seat manufacturer's instructions permit and specify using anchors spaced at least as far apart as those in this vehicle.

Each time you use the safety seat, check that the seat is properly attached to the lower anchors and tether anchor, if applicable. Tug the child seat from side to side and forward and back where it is secured to the vehicle. The seat should move less than one inch when you do this for a proper installation.

If the safety seat is not anchored properly, the risk of a child being injured in a crash greatly increases.

### ***Combining safety belt and LATCH lower anchors for attaching child safety seats***

When used in combination, either the safety belt or the LATCH lower anchors may be attached first, provided a proper installation is achieved. Attach the tether strap afterward, if included with the child seat. Refer to *Recommendations for attaching child safety restraints for children* in this chapter.

## Seating and Safety Restraints

### Attaching child safety seats with tether straps

Many forward-facing child safety seats include a tether strap which extends from the back of the child safety seat and hooks to an anchoring point called the top tether anchor. Tether straps are available as an accessory for many older safety seats. Contact the manufacturer of your child seat for information about ordering a tether strap, or to obtain a longer tether strap if the tether strap on your safety seat does not reach the appropriate top tether anchor in the vehicle.

The rear seats of your vehicle are equipped with built-in tether strap anchors located behind the seats as described below.

**Four door:** The tether anchors in your vehicle are located under a cover marked with the tether anchor symbol (shown with title).

**Five door:** The tether anchors in your vehicle are located on the back panel of the rear seat, marked with the tether anchor symbol (shown with title).

The tether strap anchors in your vehicle are in the following positions (shown from top view):

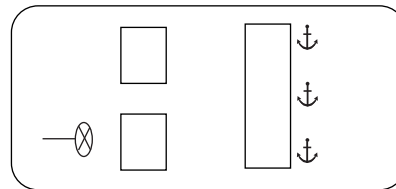

Attach the tether strap only to the appropriate tether anchor as shown. The tether strap may not work properly if attached somewhere other than the correct tether anchor.

Once the child safety seat has been installed using either the safety belt, the lower anchors of the LATCH system, or both, you can attach the top tether strap.

If you install a child seat with rigid LATCH attachments, do not tighten the tether strap enough to lift the child seat off the vehicle seat cushion when the child is seated in it. Keep the tether strap just snug without lifting the front of the child seat. Keeping the child seat just touching the vehicle seat gives the best protection in a severe crash.

## Seating and Safety Restraints

Perform the following steps to install a child safety seat with tether anchors:

### **Four door**

1. Route the child safety seat tether strap over the back of the seat.  
For outboard seating positions, route the tether strap under the head restraint and between the head restraint posts. For the center seating positions, route the tether strap over the top of the head restraint.
2. Locate the correct anchor for the selected seating position.



3. Open the tether anchor cover.



4. Clip the tether strap to the anchor as shown.  
If the tether strap is clipped incorrectly, the child safety seat may not be retained properly in the event of a collision.



5. Tighten the child safety seat tether strap according to the manufacturer's instructions.  
If the safety seat is not anchored properly, the risk of a child being injured in a collision greatly increases.  
If your child restraint system is equipped with a tether strap, and the child restraint manufacturer recommends its use, Ford also recommends its use.

## Seating and Safety Restraints

### **Five door**

1. Route the child safety seat tether strap over the back of the seat.

For outboard seating positions, route the tether strap under the head restraint and between the head restraint posts. For the center seating position, route the tether strap over the top of the head restraint.

2. Locate the correct anchor for the selected seating position.

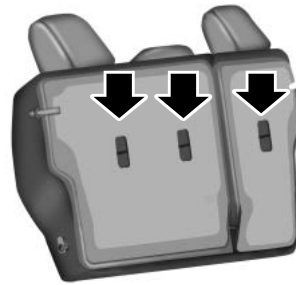

3. Clip the tether strap to the anchor as shown.

If the tether strap is clipped incorrectly, the child safety seat may not be retained properly in the event of a collision.



4. Tighten the child safety seat tether strap according to the manufacturer's instructions.

If the safety seat is not anchored properly, the risk of a child being injured in a collision greatly increases.

If your child restraint system is equipped with a tether strap, and the child restraint manufacturer recommends its use, Ford also recommends its use.

## Seating and Safety Restraints

### Child booster seats

The belt-positioning booster (booster seat) is used to improve the fit of the vehicle safety belt. Children outgrow a typical child seat (e.g., convertible or toddler seat) when they weigh about 40 lb (18 kg) and are around four (4) years of age. Consult your child safety seat owner guide for the weight, height, and age limits specific to your child safety seat. Keep your child in the child safety seat if it properly fits the child, remains appropriate for their weight, height and age AND if properly secured to the vehicle.

Although the lap/shoulder belt will provide some protection, children who have outgrown a typical child seat are still too small for lap/shoulder belts to fit properly, and wearing an improperly fitted vehicle safety belt could increase the risk of serious injury in a crash. To improve the fit of both the lap and shoulder belt on children who have outgrown child safety seats, Ford Motor Company recommends use of a belt-positioning booster.

Booster seats position a child so that vehicle lap/shoulder safety belts fit better. They lift the child up so that the lap belt rests low across the hips and the knees bend comfortably at the edge of the cushion, while minimizing slouching. Booster seats may also make the shoulder belt fit better and more comfortably. Try to keep the belt near the middle of the shoulder and across the center of the chest. Moving the child closer (a few centimeters or inches) to the center of the vehicle, but remaining in the same seating position, may help provide a good shoulder belt fit.

### ***When children should use booster seats***

Children need to use booster seats from the time they outgrow the toddler seat until they are big enough for the vehicle seat and lap/shoulder belt to fit properly. Generally this is when they reach a height of at least 4 feet 9 inches (1.45 meters) tall (around age eight to age twelve and between 40 lb (18 kg) and 80 lb (36 kg) or upward to 100 lb (45 kg) if recommended by your child restraint manufacturer). Many state and provincial laws require that children use approved booster seats until they reach age eight, a height of 4 feet 9 inches (1.45 meters) tall, or 80 lb (36 kg).



## Seating and Safety Restraints

Booster seats should be used until you can answer YES to ALL of these questions when seated without a booster seat:

- Can the child sit all the way back against the vehicle seat back with knees bent comfortably at the edge of the seat cushion?
- Can the child sit without slouching?

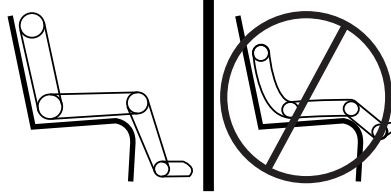

- Does the lap belt rest low across the hips?
- Is the shoulder belt centered on the shoulder and chest?
- Can the child stay seated like this for the whole trip?

### **Types of booster seats**

There are generally two types of belt-positioning booster seats: backless and high back. Always use booster seats in conjunction with the vehicle lap/shoulder belt.

- Backless booster seats

If your backless booster seat has a removable shield, remove the shield. If a vehicle seating position has a low seat back or no head restraint, a backless booster seat may place your child's head (as measured at the tops of the ears) above the top of the seat. In this case, move the backless booster to another seating position with a higher seat back or head restraint and lap/shoulder belts, or consider using a high back booster seat.



## Seating and Safety Restraints

- High back booster seats

If, with a backless booster seat, you cannot find a seating position that adequately supports your child's head, a high back booster seat would be a better choice.



Children and booster seats vary in size and shape. Choose a booster that keeps the lap belt low and snug across the hips, never up across the stomach, and lets you adjust the shoulder belt to cross the chest and rest snugly near the center of the shoulder. The drawings below compare the ideal fit (center) to a shoulder belt uncomfortably close to the neck and a shoulder belt that could slip off the shoulder. The drawings below also show how the lap belt should be low and snug across the child's hips.

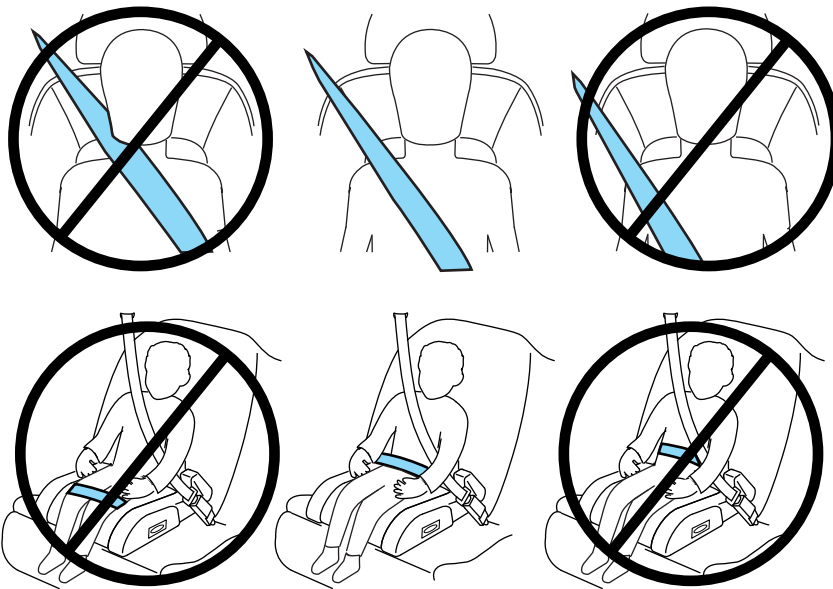

## Seating and Safety Restraints

If the booster seat slides on the vehicle seat, placing a rubberized mesh sold as shelf or carpet liner under the booster seat may improve this condition. Do not introduce any item thicker than this under the booster seat. Check with the booster seat manufacturer's instructions.

### ***The importance of shoulder belts***

Using a booster without a shoulder belt increases the risk of a child's head hitting a hard surface in a collision. For this reason, you should never use a booster seat with a lap belt only. It is generally best to use a booster seat with lap/shoulder belts in the back seat.

Move a child to a different seating location if the shoulder belt does not stay positioned on the shoulder during use.

Follow all instructions provided by the manufacturer of the booster seat.



**WARNING:** Never place, or allow a child to place, the shoulder belt under a child's arm or behind the back because it reduces the protection for the upper part of the body and may increase the risk of injury or death in a collision.

## Seating and Safety Restraints

### Child restraint and safety belt maintenance

Inspect the vehicle safety belts and child safety seat systems periodically to make sure they work properly and are not damaged. Inspect the vehicle and child seat safety belts to make sure there are no nicks, tears or cuts. Replace if necessary. All vehicle safety belt assemblies, including retractors, buckles, front safety belt buckle assemblies, buckle support assemblies (slide bar-if equipped), shoulder belt height adjusters (if equipped), shoulder belt guide on seatback (if equipped), child safety seat LATCH and tether anchors, and attaching hardware, should be inspected after a collision. Refer to the child restraint manufacturer's instructions for additional inspection and maintenance information specific to the child restraint. Ford Motor Company recommends that all safety belt assemblies in use in vehicles involved in a collision be replaced. However, if the collision was minor and an authorized dealer finds that the belts do not show damage and continue to operate properly, they do not need to be replaced. Safety belt assemblies not in use during a collision should also be inspected and replaced if either damage or improper operation is noted.

For proper care of soiled safety belts, refer to *Interior* in the *Cleaning* chapter.



**WARNING:** Failure to inspect and if necessary replace the safety belt assembly or child restraint system under the above conditions could result in severe personal injuries in the event of a collision.

## Tires, Wheels and Loading

### INFORMATION ABOUT UNIFORM TIRE QUALITY GRADING

Tire Quality Grades apply to new pneumatic passenger car tires. The Quality grades can be found where applicable on the tire sidewall between tread shoulder and maximum section width. For example:

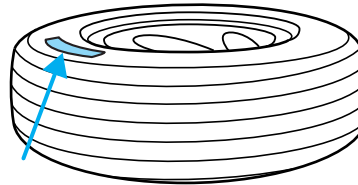

- **Treadwear 200 Traction AA Temperature A**

These Tire Quality Grades are determined by standards that the United States Department of Transportation has set.

Tire Quality Grades apply to new pneumatic passenger car tires. They do not apply to deep tread, winter-type snow tires, space-saver or temporary use spare tires, light truck or "LT" type tires, tires with nominal rim diameters of 10 to 12 inches or limited production tires as defined in Title 49 Code of Federal Regulations Part 575.104(c)(2).

**U.S. Department of Transportation-Tire quality grades:** The U.S. Department of Transportation requires Ford Motor Company to give you the following information about tire grades exactly as the government has written it.

#### Treadwear

The treadwear grade is a comparative rating based on the wear rate of the tire when tested under controlled conditions on a specified government test course. For example, a tire graded 150 would wear one and one-half (1½) times as well on the government course as a tire graded 100. The relative performance of tires depends upon the actual conditions of their use, however, and may depart significantly from the norm due to variations in driving habits, service practices, and differences in road characteristics and climate.

#### Traction AA A B C



**WARNING:** The traction grade assigned to this tire is based on straight-ahead braking traction tests, and does not include acceleration, cornering, hydroplaning or peak traction characteristics.

The traction grades, from highest to lowest are AA, A, B, and C. The grades represent the tire's ability to stop on wet pavement as measured under controlled conditions on specified government test surfaces of asphalt and concrete. A tire marked C may have poor traction performance.

## Tires, Wheels and Loading

### Temperature A B C



**WARNING:** The temperature grade for this tire is established for a tire that is properly inflated and not overloaded. Excessive speed, underinflation, or excessive loading, either separately or in combination, can cause heat buildup and possible tire failure.

The temperature grades are A (the highest), B and C, representing the tire's resistance to the generation of heat and its ability to dissipate heat when tested under controlled conditions on a specified indoor laboratory test wheel. Sustained high temperature can cause the material of the tire to degenerate and reduce tire life, and excessive temperature can lead to sudden tire failure. The grade C corresponds to a level of performance which all passenger car tires must meet under the Federal Motor Vehicle Safety Standard No. 139. Grades B and A represent higher levels of performance on the laboratory test wheel than the minimum required by law.

### TIRES

Tires are designed to give many thousands of miles of service, but they must be maintained in order to get the maximum benefit from them.

#### Glossary of Tire Terminology

- **Tire label:** A label showing the OE (Original Equipment) tire sizes, recommended inflation pressure and the maximum weight the vehicle can carry.
- **Tire Identification Number (TIN):** A number on the sidewall of each tire providing information about the tire brand and manufacturing plant, tire size and date of manufacture. Also referred to as DOT code.
- **Inflation pressure:** A measure of the amount of air in a tire.
- **Standard load:** A class of P-metric or Metric tires designed to carry a maximum load at 35 psi [37 psi (2.5 bar) for Metric tires]. Increasing the inflation pressure beyond this pressure will not increase the tire's load carrying capability.
- **Extra load:** A class of P-metric or Metric tires designed to carry a heavier maximum load at 41 psi [43 psi (2.9 bar) for Metric tires]. Increasing the inflation pressure beyond this pressure will not increase the tire's load carrying capability.
- **kPa:** Kilopascal, a metric unit of air pressure.

## Tires, Wheels and Loading

- **PSI:** Pounds per square inch, a standard unit of air pressure.
- **Cold inflation pressure:** The tire pressure when the vehicle has been stationary and out of direct sunlight for an hour or more and prior to the vehicle being driven for 1 mile (1.6 km).
- **Recommended inflation pressure:** The cold inflation pressure found on the Safety Compliance Certification Label (affixed to either the door hinge pillar, door-latch post, or the door edge that meets the door-latch post, next to the driver's seating position), or Tire Label located on the B-Pillar or the edge of the driver's door.
- **B-pillar:** The structural member at the side of the vehicle behind the front door.
- **Bead area of the tire:** Area of the tire next to the rim.
- **Sidewall of the tire:** Area between the bead area and the tread.
- **Tread area of the tire:** Area of the perimeter of the tire that contacts the road when mounted on the vehicle.
- **Rim:** The metal support (wheel) for a tire or a tire and tube assembly upon which the tire beads are seated.

### INFLATING YOUR TIRES

Safe operation of your vehicle requires that your tires are properly inflated. Remember that a tire can lose up to half of its air pressure without appearing flat.

Every day before you drive, check your tires. If one looks lower than the others, use a tire gauge to check pressure of all tires and adjust if required.

At least once a month and before long trips, inspect each tire and check the tire pressure with a tire gauge (including spare, if equipped). Inflate all tires to the inflation pressure recommended by Ford Motor Company.

You are strongly urged to buy a reliable tire pressure gauge, as automatic service station gauges may be inaccurate. Ford recommends the use of a digital or dial-type tire pressure gauge rather than a stick-type tire pressure gauge.

Use the recommended cold inflation pressure for optimum tire performance and wear. Under-inflation or over-inflation may cause uneven treadwear patterns.

## Tires, Wheels and Loading



**WARNING:** Under-inflation is the most common cause of tire failures and may result in severe tire cracking, tread separation or “blowout”, with unexpected loss of vehicle control and increased risk of injury. Under-inflation increases sidewall flexing and rolling resistance, resulting in heat buildup and internal damage to the tire. It also may result in unnecessary tire stress, irregular wear, loss of vehicle control and accidents. A tire can lose up to half of its air pressure and not appear to be flat!

Always inflate your tires to the Ford recommended inflation pressure even if it is less than the maximum inflation pressure information found on the tire. The Ford recommended tire inflation pressure is found on the Safety Compliance Certification Label (affixed to either the door hinge pillar, door-latch post, or the door edge that meets the door-latch post, next to the driver's seating position), or Tire Label which is located on the B-Pillar or the edge of the driver's door. Failure to follow the tire pressure recommendations can cause uneven treadwear patterns and adversely affect the way your vehicle handles.

**Maximum Permissible Inflation Pressure** is the tire manufacturer's maximum permissible pressure and/or the pressure at which the maximum load can be carried by the tire. This pressure is normally higher than the manufacturer's recommended cold inflation pressure which can be found on the Safety Compliance Certification Label (affixed to either the door hinge pillar, door-latch post, or the door edge that meets the door-latch post, next to the driver's seating position), or Tire Label which is located on the B-Pillar or the edge of the driver's door. The cold inflation pressure should never be set lower than the recommended pressure on the Safety Compliance Certification Label or Tire Label.

When weather temperature changes occur, tire inflation pressures also change. A 10°F (6°C) temperature drop can cause a corresponding drop of 1 psi (7 kPa) in inflation pressure. Check your tire pressures frequently and adjust them to the proper pressure which can be found on the Safety Compliance Certification Label or Tire Label.

To check the pressure in your tire(s):

1. Make sure the tires are cool, meaning they are not hot from driving even a mile.

If you are checking tire pressure when the tire is hot, (i.e. driven more than 1 mile [1.6 km]), never “bleed” or reduce air pressure. The tires are hot from driving and it is normal for pressures to increase above recommended cold pressures. A hot tire at or below recommended cold inflation pressure could be significantly under-inflated.



## Tires, Wheels and Loading

**Note:** If you have to drive a distance to get air for your tire(s), check and record the tire pressure first and add the appropriate air pressure when you get to the pump. It is normal for tires to heat up and the air pressure inside to go up as you drive.

2. Remove the cap from the valve on one tire, then firmly press the tire gauge onto the valve and measure the pressure.

3. Add enough air to reach the recommended air pressure.

**Note:** If you overfill the tire, release air by pressing on the metal stem in the center of the valve. Then recheck the pressure with your tire gauge.

4. Replace the valve cap.

5. Repeat this procedure for each tire, including the spare.

**Note:** Some spare tires operate at a higher inflation pressure than the other tires. For T-type/mini-spare tires (see the *Dissimilar spare tire and wheel assembly information* section for description): Store and maintain at 60 psi (4.15 bar). For full-size and dissimilar spare tires (see the *Dissimilar spare tire and wheel assembly information* section for description): Store and maintain at the higher of the front and rear inflation pressure as shown on the Tire Label.

6. Visually inspect the tires to make sure there are no nails or other objects embedded that could poke a hole in the tire and cause an air leak.

7. Check the sidewalls to make sure there are no gouges, cuts or bulges.

### TIRE CARE

#### Inspecting your tires and wheel valve stems

Periodically inspect the tire treads for uneven or excessive wear and remove objects such as stones, nails or glass that may be wedged in the tread grooves. Check the tire and valve stems for holes, cracks, or cuts that may permit air leakage and repair or replace the tire and replace the valve stem. Inspect the tire sidewalls for cracking, cuts, bruises and other signs of damage or excessive wear. If internal damage to the tire is suspected, have the tire demounted and inspected in case it needs to be repaired or replaced. For your safety, tires that are damaged or show signs of excessive wear should not be used because they are more likely to blow out or fail.

## Tires, Wheels and Loading

Improper or inadequate vehicle maintenance can cause tires to wear abnormally. Inspect all your tires, including the spare, frequently, and replace them if one or more of the following conditions exist:

### Tire wear

When the tread is worn down to 1/16th of an inch (2 mm), tires must be replaced to help prevent your vehicle from skidding and hydroplaning. Built-in treadwear indicators, or “wear bars”, which look like narrow strips of smooth rubber across the tread will appear on the tire when the tread is worn down to 1/16th of an inch (2 mm).

When the tire tread wears down to the same height as these “wear bars”, the tire is worn out and must be replaced.

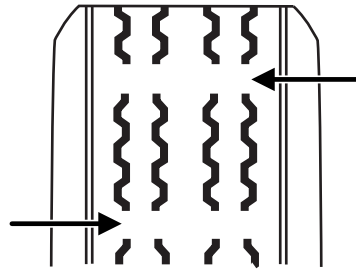

### Damage

Periodically inspect the tire treads and sidewalls for damage (such as bulges in the tread or sidewalls, cracks in the tread groove and separation in the tread or sidewall). If damage is observed or suspected have the tire inspected by a tire professional. Tires can be damaged during off-road use, so inspection after off-road use is also recommended.



### **WARNING: Age**

Tires degrade over time depending on many factors such as weather, storage conditions, and conditions of use (load, speed, inflation pressure, etc.) the tires experience throughout their lives. In general, tires should be replaced after six years regardless of tread wear. However, heat caused by hot climates or frequent high loading conditions can accelerate the aging process and may require tires to be replaced more frequently.

You should replace your spare tire when you replace the road tires or after six years due to aging even if it has not been used.

## Tires, Wheels and Loading

### U.S. DOT Tire Identification Number (TIN)

Both U.S. and Canada Federal regulations require tire manufacturers to place standardized information on the sidewall of all tires. This information identifies and describes the fundamental characteristics of the tire and also provides a U.S. DOT Tire Identification Number for safety standard certification and in case of a recall.

This begins with the letters “DOT” and indicates that the tire meets all federal standards. The next two numbers or letters are the plant code designating where it was manufactured, the next two are the tire size code and the last four numbers represent the week and year the tire was built. For example, the numbers 317 mean the 31st week of 1997. After 2000 the numbers go to four digits. For example, 2501 means the 25th week of 2001. The numbers in between are identification codes used for traceability. This information is used to contact customers if a tire defect requires a recall.

### Tire Replacement Requirements

Your vehicle is equipped with tires designed to provide a safe ride and handling capability.



**WARNING:** Only use replacement tires and wheels that are the same size, load index, speed rating and type (such as P-metric versus LT-metric or all-season versus all-terrain) as those originally provided by Ford. The recommended tire and wheel size may be found on either the Safety Compliance Certification Label (affixed to either the door hinge pillar, door-latch post, or the door edge that meets the door-latch post, next to the driver’s seating position), or the Tire Label which is located on the B-Pillar or edge of the driver’s door. If this information is not found on these labels then you should contact your authorized dealer as soon as possible. Use of any tire or wheel not recommended by Ford can affect the safety and performance of your vehicle, which could result in an increased risk of loss of vehicle control, vehicle rollover, personal injury and death. Additionally the use of non-recommended tires and wheels could cause steering, suspension, axle or transfer case/power transfer unit failure. If you have questions regarding tire replacement, contact your authorized dealer as soon as possible.

## Tires, Wheels and Loading



**WARNING:** When mounting replacement tires and wheels, you should not exceed the maximum pressure indicated on the sidewall of the tire to set the beads without additional precautions listed below. If the beads do not seat at the maximum pressure indicated, re-lubricate and try again.

When inflating the tire for mounting pressures up to 20 psi (1.38 bar) greater than the maximum pressure on the tire sidewall, the following precautions must be taken to protect the person mounting the tire:

1. Make sure that you have the correct tire and wheel size.
2. Lubricate the tire bead and wheel bead seat area again.
3. Stand at a minimum of 12 ft (3.66 m) away from the tire wheel assembly.
4. Use both eye and ear protection.

For a mounting pressure more than 20 psi (1.38 bar) greater than the maximum pressure, a Ford dealer or other tire service professional should do the mounting.

Always inflate steel carcass tires with a remote air fill with the person inflating standing at a minimum of 12 ft (3.66 m) away from the tire wheel assembly.

**Important:** Remember to replace the wheel valve stems when the road tires are replaced on your vehicle.

It is recommended that the two front tires or two rear tires generally be replaced as a pair.

The tire pressure sensors mounted in the wheels (originally installed on your vehicle) are not designed to be used in aftermarket wheels.

The use of wheels or tires not recommended by Ford Motor Company may affect the operation of your tire pressure monitoring system.

If the TPMS indicator is flashing, your TPMS is malfunctioning. Your replacement tire might be incompatible with your TPMS, or some component of the TPMS may be damaged.

## Tires, Wheels and Loading

### Safety Practices



**WARNING:** If your vehicle is stuck in snow, mud, sand, etc., do not rapidly spin the tires; spinning the tires can tear the tire and cause an explosion. A tire can explode in as little as three to five seconds.



**WARNING:** Do not spin the wheels at over 35 mph (56 km/h). The tires may fail and injure a passenger or bystander.

Driving habits have a great deal to do with your tire mileage and safety.

- Observe posted speed limits
- Avoid fast starts, stops and turns
- Avoid potholes and objects on the road
- Do not run over curbs or hit the tire against a curb when parking

### Highway hazards

No matter how carefully you drive there's always the possibility that you may eventually have a flat tire on the highway. Drive slowly to the closest safe area out of traffic. This may further damage the flat tire, but your safety is more important.

If you feel a sudden vibration or ride disturbance while driving, or you suspect your tire or vehicle has been damaged, immediately reduce your speed. Drive with caution until you can safely pull off the road. Stop and inspect the tires for damage. If a tire is under-inflated or damaged, deflate it, remove wheel and replace it with your spare tire and wheel. If you cannot detect a cause, have the vehicle towed to the nearest repair facility or tire dealer to have the vehicle inspected.

## Tires, Wheels and Loading

### Tire and Wheel Alignment

A bad jolt from hitting a curb or pothole can cause the front end of your vehicle to become misaligned or cause damage to your tires. If your vehicle seems to pull to one side when you're driving, the wheels may be out of alignment. Have an authorized dealer check the wheel alignment periodically.

Wheel misalignment in the front or the rear can cause uneven and rapid treadwear of your tires and should be corrected by an authorized dealer. Front-wheel drive (FWD) vehicles and those with an independent rear suspension (if equipped) may require alignment of all four wheels.

The tires should also be balanced periodically. An unbalanced tire and wheel assembly may result in irregular tire wear.

### Tire Rotation

Rotating your tires at the recommended interval (as indicated in the *Scheduled Maintenance* chapter) will help your tires wear more evenly, providing better tire performance and longer tire life.

- Front-wheel drive (FWD) vehicles  
(front tires at top of diagram)

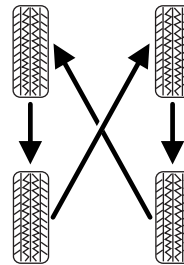

Sometimes irregular tire wear can be corrected by rotating the tires.

**Note:** If your tires show uneven wear ask an authorized dealer to check for and correct any wheel misalignment, tire imbalance or mechanical problem involved before tire rotation.

**Note:** Your vehicle may be equipped with a dissimilar spare tire/wheel. A dissimilar spare tire/wheel is defined as a spare tire and/or wheel that is different in brand, size or appearance from the road tires and wheels. If you have a dissimilar spare tire/wheel it is intended for temporary use only and should not be used in a tire rotation.

**Note:** After having your tires rotated, inflation pressure must be checked and adjusted to the vehicle requirements.

## Tires, Wheels and Loading

### INFORMATION CONTAINED ON THE TIRE SIDEWALL

Both U.S. and Canada Federal regulations require tire manufacturers to place standardized information on the sidewall of all tires. This information identifies and describes the fundamental characteristics of the tire and also provides a U.S. DOT Tire Identification Number for safety standard certification and in case of a recall.

#### Information on “P” type tires

P215/65R15 95H is an example of a tire size, load index and speed rating. The definitions of these items are listed below. (Note that the tire size, load index and speed rating for your vehicle may be different from this example.)

1. **P:** Indicates a tire, designated by the Tire and Rim Association (T&RA), that may be used for service on cars, SUVs, minivans and light trucks.

**Note:** If your tire size does not begin with a letter this may mean it is designated by either ETRTO (European Tire and Rim Technical Organization) or JATMA (Japan Tire Manufacturing Association).

2. **215:** Indicates the nominal width of the tire in millimeters from sidewall edge to sidewall edge. In general, the larger the number, the wider the tire.

3. **65:** Indicates the aspect ratio which gives the tire’s ratio of height to width.

4. **R:** Indicates a “radial” type tire.

5. **15:** Indicates the wheel or rim diameter in inches. If you change your wheel size, you will have to purchase new tires to match the new wheel diameter.

6. **95:** Indicates the tire’s load index. It is an index that relates to how much weight a tire can carry. You may find this information in your owner’s guide. If not, contact a local tire dealer.

**Note:** You may not find this information on all tires because it is not required by federal law.

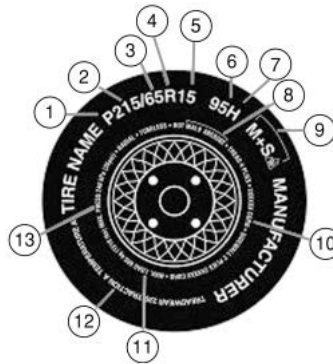

## Tires, Wheels and Loading

7. **H:** Indicates the tire's speed rating. The speed rating denotes the speed at which a tire is designed to be driven for extended periods of time under a standard condition of load and inflation pressure. The tires on your vehicle may operate at different conditions for load and inflation pressure. These speed ratings may need to be adjusted for the difference in conditions. The ratings range from 81 mph (130 km/h) to 186 mph (299 km/h). These ratings are listed in the following chart.

**Note:** You may not find this information on all tires because it is not required by federal law.

Letter rating	Speed rating - mph (km/h)
M	81 mph (130 km/h)
N	87 mph (140 km/h)
Q	99 mph (159 km/h)
R	106 mph (171 km/h)
S	112 mph (180 km/h)
T	118 mph (190 km/h)
U	124 mph (200 km/h)
H	130 mph (210 km/h)
V	149 mph (240 km/h)
W	168 mph (270 km/h)
Y	186 mph (299 km/h)

**Note:** For tires with a maximum speed capability over 149 mph (240 km/h), tire manufacturers sometimes use the letters ZR. For those with a maximum speed capability over 186 mph (299 km/h), tire manufacturers always use the letters ZR.

8. **U.S. DOT Tire Identification Number (TIN):** This begins with the letters "DOT" and indicates that the tire meets all federal standards. The next two numbers or letters are the plant code designating where it was manufactured, the next two are the tire size code and the last four numbers represent the week and year the tire was built. For example, the numbers 317 mean the 31st week of 1997. After 2000 the numbers go to four digits. For example, 2501 means the 25th week of 2001. The numbers in between are identification codes used for traceability. This information is used to contact customers if a tire defect requires a recall.

9. **M+S or M/S:** Mud and Snow, or

**AT:** All Terrain, or

**AS:** All Season.



## Tires, Wheels and Loading

10. **Tire Ply Composition and Material Used:** Indicates the number of plies or the number of layers of rubber-coated fabric in the tire tread and sidewall. Tire manufacturers also must indicate the ply materials in the tire and the sidewall, which include steel, nylon, polyester, and others.

11. **Maximum Load:** Indicates the maximum load in kilograms and pounds that can be carried by the tire. Refer to the Safety Compliance Certification Label, which is located on the B-Pillar or the edge of the driver's door, for the correct tire pressure for your vehicle.

### 12. Treadwear, Traction and Temperature Grades

- **Treadwear:** The treadwear grade is a comparative rating based on the wear rate of the tire when tested under controlled conditions on a specified government test course. For example, a tire graded 150 would wear one and one-half (1½) times as well on the government course as a tire graded 100.
- **Traction:** The traction grades, from highest to lowest are AA, A, B, and C. The grades represent the tire's ability to stop on wet pavement as measured under controlled conditions on specified government test surfaces of asphalt and concrete. A tire marked C may have poor traction performance.
- **Temperature:** The temperature grades are A (the highest), B and C, representing the tire's resistance to the generation of heat and its ability to dissipate heat when tested under controlled conditions on a specified indoor laboratory test wheel.

13. **Maximum Permissible Inflation Pressure:** Indicates the tire manufacturers' maximum permissible pressure and/or the pressure at which the maximum load can be carried by the tire. This pressure is normally higher than the manufacturer's recommended cold inflation pressure which can be found on the Safety Compliance Certification Label or Tire Label which is located on the B-Pillar or the edge of the driver's door. The cold inflation pressure should never be set lower than the recommended pressure on the vehicle label.

The tire suppliers may have additional markings, notes or warnings such as standard load, radial tubeless, etc.

## Tires, Wheels and Loading

### Additional information contained on the tire sidewall for “LT” type tires

“LT” type tires have some additional information beyond those of “P” type tires; these differences are described below.

**Note:** Tire Quality Grades do not apply to this type of tire.

1. **LT:** Indicates a tire, designated by the Tire and Rim Association (T&RA), that is intended for service on light trucks.

#### 2. Load Range/Load Inflation

**Limits:** Indicates the tire’s load-carrying capabilities and its inflation limits.

3. **Maximum Load Dual lb (kg) at psi (kPa) cold:** Indicates the maximum load and tire pressure when the tire is used as a dual; defined as four tires on the rear axle (a total of six or more tires on the vehicle).

4. **Maximum Load Single lb (kg) at psi (kPa) cold:** Indicates the maximum load and tire pressure when the tire is used as a single; defined as two tires (total) on the rear axle.

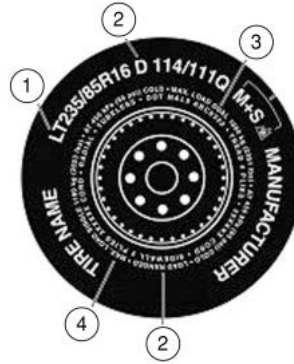

## Tires, Wheels and Loading

### Information on “T” type tires

“T” type tires have some additional information beyond those of “P” type tires; these differences are described below:

T145/80D16 is an example of a tire size.

**Note:** The temporary tire size for your vehicle may be different from this example. Tire Quality Grades do not apply to this type of tire.

1. **T:** Indicates a type of tire, designated by the Tire and Rim Association (T&RA), that is intended for temporary service on cars, SUVs, minivans and light trucks.

2. **145:** Indicates the nominal width of the tire in millimeters from sidewall edge to sidewall edge. In general, the larger the number, the wider the tire.

3. **80:** Indicates the aspect ratio which gives the tire’s ratio of height to width. Numbers of 70 or lower indicate a short sidewall.

4. **D:** Indicates a “diagonal” type tire.

**R:** Indicates a “radial” type tire.

5. **16:** Indicates the wheel or rim diameter in inches. If you change your wheel size, you will have to purchase new tires to match the new wheel diameter.

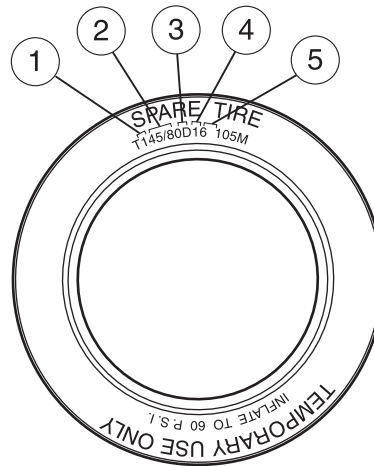

### Location of the tire label

You will find a Tire Label containing tire inflation pressure by tire size and other important information located on the B-Pillar or the edge of the driver’s door. Refer to the payload description and graphic in the *Vehicle loading* section.

## Tires, Wheels and Loading

### TIRE PRESSURE MONITORING SYSTEM (TPMS)

Each tire, including the spare (if provided), should be checked monthly when cold and inflated to the inflation pressure recommended by the vehicle manufacturer on the vehicle placard or tire inflation pressure label. (If your vehicle has tires of a different size than the size indicated on the vehicle placard or tire inflation pressure label, you should determine the proper tire inflation pressure for those tires.)

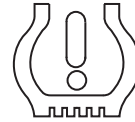

As an added safety feature, your vehicle has been equipped with a tire pressure monitoring system (TPMS) that illuminates a low tire pressure telltale when one or more of your tires is significantly under-inflated. Accordingly, when the low tire pressure telltale illuminates, you should stop and check your tires as soon as possible, and inflate them to the proper pressure. Driving on a significantly under-inflated tire causes the tire to overheat and can lead to tire failure. Under-inflation also reduces fuel efficiency and tire tread life, and may affect the vehicle's handling and stopping ability.

Please note that the TPMS is not a substitute for proper tire maintenance, and it is the driver's responsibility to maintain correct tire pressure, even if under-inflation has not reached the level to trigger illumination of the TPMS low tire pressure telltale.

Your vehicle has also been equipped with a TPMS malfunction indicator to indicate when the system is not operating properly. The TPMS malfunction indicator is combined with the low tire pressure telltale. When the system detects a malfunction, the telltale will flash for approximately one minute and then remain continuously illuminated. This sequence will continue upon subsequent vehicle start-ups as long as the malfunction exists.

When the malfunction indicator is illuminated, the system may not be able to detect or signal low tire pressure as intended. TPMS malfunctions may occur for a variety of reasons, including the installation of replacement or alternate tires or wheels on the vehicle that prevent the TPMS from functioning properly. Always check the TPMS malfunction telltale after replacing one or more tires or wheels on your vehicle to ensure that the replacement or alternate tires and wheels allow the TPMS to continue to function properly.

The tire pressure monitoring system complies with part 15 of the FCC rules and with RSS-210 of Industry Canada. Operation is subject to the

220

<https://www.MyCarManual.com>

## Tires, Wheels and Loading

following two conditions: (1) This device may not cause harmful interference, and (2) This device must accept any interference received, including interference that may cause undesired operation.



**WARNING:** The tire pressure monitoring system is NOT a substitute for manually checking tire pressure. The tire pressure should be checked periodically (at least monthly) using a tire gauge, see *Inflating your tires* in this chapter. Failure to properly maintain your tire pressure could increase the risk of tire failure, loss of control, vehicle rollover and personal injury.

### Changing Tires with a TPMS

**Note:** Each road tire is equipped with a tire pressure sensor located inside the tire and wheel assembly cavity. The pressure sensor is attached to the valve stem. The pressure sensor is covered by the tire and is not visible unless the tire is removed. Care must be taken when changing the tire to avoid damaging the sensor.

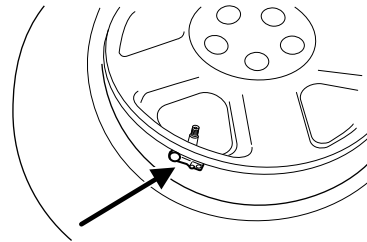

It is recommended that you always have your tires serviced by an authorized dealer.

The tire pressure should be checked periodically (at least monthly) using an accurate tire gauge, refer to *Inflating your tires* in this chapter.

### Understanding your tire pressure monitoring system (TPMS)

The tire pressure monitoring system measures pressure in your four road tires and sends the tire pressure readings to your vehicle. The low tire pressure warning light will turn on if the tire pressure is significantly low. Once the light is illuminated, your tires are under-inflated and need to be inflated to the manufacturer's recommended tire pressure. Even if the light turns on and a short time later turns off, your tire pressure still needs to be checked. Visit [www.checkmytires.org](http://www.checkmytires.org) for additional information.

### When your temporary spare tire is installed

When one of your road tires needs to be replaced with the temporary spare, the TPMS will continue to identify an issue to remind you that the damaged road wheel/tire needs to be repaired and put back on your vehicle.

## Tires, Wheels and Loading

To restore the full functionality of the tire pressure monitoring system, have the damaged road wheel/tire repaired and remounted on your vehicle. For additional information, refer to *Changing tires with a TPMS* in this section.

### **When you believe your system is not operating properly**

The main function of the tire pressure monitoring system is to warn you when your tires need air. It can also warn you in the event the system is no longer capable of functioning as intended. Please refer to the following chart for information concerning your tire pressure monitoring system:

Low tire pressure warning light	Possible cause	Customer action required
Solid warning light	Tire(s) under-inflated	1. Make sure tires are at the proper pressure. See <i>Inflating your tires</i> in this chapter. 2. After inflating your tires to the manufacturer's recommended pressure as shown on the Tire Label (located on the edge of driver's door or the B-Pillar), the vehicle must be driven for at least two minutes over 20 mph (32 km/h) before the light turns off.
	Spare tire in use	Repair the damaged road wheel/tire and reinstall it on the vehicle to restore system functionality. For a description on how the system functions, refer to <i>When your temporary spare tire is installed</i> in this section.
	TPMS malfunction	If the tires are properly inflated and the spare tire is not in use but the light remains on, contact your authorized dealer as soon as possible.

## Tires, Wheels and Loading

Low tire pressure warning light	Possible cause	Customer action required
Flashing warning light	Spare tire in use	Repair the damaged road wheel/tire and reinstall it on the vehicle to restore system functionality. For a description on how the system functions, refer to <i>When your temporary spare tire is installed</i> in this section.
	TPMS malfunction	If the tires are properly inflated and the spare tire is not in use but the light remains on, contact your authorized dealer as soon as possible.

### **When inflating your tires**

When putting air into your tires (such as at a gas station or in your garage), the tire pressure monitoring system may not respond immediately to the air added to your tires.

It may take up to two minutes of driving over 20 mph (32 km/h) for the light to turn off after you have filled your tires to the recommended inflation pressure.

### **How temperature affects your tire pressure**

The tire pressure monitoring system (TPMS) monitors tire pressure in each pneumatic tire. While driving in a normal manner, a typical passenger tire inflation pressure may increase approximately 2 to 4 psi (14 to 28 kPa) from a cold start situation. If the vehicle is stationary overnight with the outside temperature significantly lower than the daytime temperature, the tire pressure may decrease approximately 3 psi (21 kPa) for a drop of 30°F (17°C) in ambient temperature. This lower pressure value may be detected by the TPMS as being significantly lower than the recommended inflation pressure and activate the TPMS warning light for low tire pressure. If the low tire pressure warning light is on, visually check each tire to verify that no tire is flat. (If one or more tires are flat, repair as necessary.) Check air pressure in the road tires. If any tire is under-inflated, carefully drive the vehicle to the nearest location where air can be added to the tires. Inflate all the tires to the recommended inflation pressure.

## Tires, Wheels and Loading

### SNOW TIRES AND CHAINS



**WARNING:** Snow tires must be the same size, load index, speed rating as those originally provided by Ford. Use of any tire or wheel not recommended by Ford can affect the safety and performance of your vehicle, which could result in an increased risk of loss of vehicle control, vehicle rollover, personal injury and death. Additionally, the use of non-recommended tires and wheels could cause steering, suspension, axle or transfer case/power transfer unit failure.

**Note:** The suspension insulation and bumpers will help prevent vehicle damage. Do not remove these components from your vehicle when using snow tires and chains.

The tires on your vehicle may have all-weather treads to provide traction in rain and snow. However, in some climates, you may need to use snow tires and chains. Use chains on the tires only in an emergency or if the law requires them.

Follow these guidelines when using snow tires and chains:

- If possible, avoid fully loading your vehicle.
- Chains may damage aluminum wheels.
- Use SAE Class S chains with 195/65R15 or 215/55R16 tires only; do not use tire chains with any other size tires.
- Install chains securely, verifying that the chains do not touch any wiring, brake lines or fuel lines.
- Drive cautiously. If you hear the chains rub or bang against your vehicle, stop and retighten the chains. If this does not work, remove the chains to prevent damage to your vehicle.
- Remove the tire chains when they are no longer needed. Do not use tire chains on dry roads.

### VEHICLE LOADING

This section will guide you in the proper loading of your vehicle to keep your loaded vehicle weight within its design rating capability. Properly loading your vehicle will provide maximum return of vehicle design performance. Before loading your vehicle, familiarize yourself with the following terms for determining your vehicle's weight ratings from the vehicle's Tire Label or Safety Compliance Certification Label:

**Base Curb Weight** – is the weight of the vehicle including a full tank of fuel and all standard equipment. It does not include passengers, cargo, or optional equipment.



## Tires, Wheels and Loading

**Vehicle Curb Weight** – is the weight of your new vehicle when you picked it up from your authorized dealer plus any aftermarket equipment.



**Payload** – is the combined weight of cargo and passengers that the vehicle is carrying. The maximum payload for your vehicle can be found on the Tire Label on the B-Pillar or the edge of the driver's door (vehicles exported outside the US and Canada may not have a Tire Label). Look for **“THE COMBINED WEIGHT OF OCCUPANTS AND CARGO SHOULD NEVER EXCEED XXX kg OR XXX lb.”** for maximum payload. The payload listed on the Tire Label is the maximum payload for the vehicle as built by the assembly plant. If any aftermarket or authorized-dealer installed equipment has been installed on the vehicle, the weight of the equipment must be subtracted from the payload listed on the Tire Label in order to determine the new payload.

 **WARNING:** The appropriate loading capacity of your vehicle can be limited either by volume capacity (how much space is available) or by payload capacity (how much weight the vehicle should carry). Once you have reached the maximum payload of your vehicle, do not add more cargo, even if there is space available. Overloading or improperly loading your vehicle can contribute to loss of vehicle control and vehicle rollover.

# Tires, Wheels and Loading

Example only:

**TIRE AND LOADING INFORMATION**

SEATING CAPACITY TOTAL 5 FRONT 2 REAR 3

The combined weight of occupants and cargo should never exceed : **XXX kg or XXX lbs.**

TIRE	SIZE	COLD TIRE PRESSURE	SEE OWNERS MANUAL FOR ADDITIONAL INFORMATION
FRONT	LT225/75R 16.5E	200 KPA, 29 PSI	
REAR	LT225/75R 16.5E	200 KPA, 29 PSI	
SPARE	T145/80D16 P225/60R17	420 KPA, 60 PSI 200 KPA, 29 PSI	

**TIRE AND LOADING INFORMATION**  
**RENSEIGNEMENTS SUR LES PNEUS ET LE CHARGEMENT**

SEATING CAPACITY TOTAL 5 FRONT 2 REAR 3  
NOMBRE DE PLACES TOTAL 5 AVANT 2 ARRIERE 3

The combined weight of occupants and cargo should never exceed 492 kg or 1085 lbs.  
Le poids total des occupants et du chargement ne doit jamais dépasser 492 kg ou 1085 lb.

TIRE PNEU	SIZE DIMENSIONS	COLD TIRE PRESSURE PRESSION DES PNEUS A FROID	SEE OWNER'S MANUAL FOR ADDITIONAL INFORMATION  VOIR LE MANUEL DE L'USAGER POUR PLUS DE RENSEIGNEMENTS
FRONT AVANT	P235/70R16	240 KPA, 35 PSI	
REAR ARRIERE	P235/70R16	240 KPA, 35 PSI	
SPARE DE SECOURS	T145/90R17	415 KPA, 60 PSI	

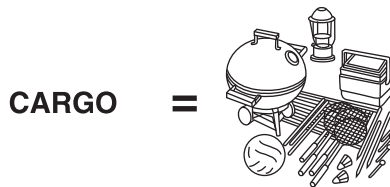

**Cargo Weight** – includes all weight added to the Base Curb Weight, including cargo and optional equipment.

## Tires, Wheels and Loading

**GAW (Gross Axle Weight)** – is the total weight placed on each axle (front and rear) – including vehicle curb weight and all payload.

**GAWR (Gross Axle Weight Rating)** – is the maximum allowable weight that can be carried by a single axle (front or rear). **These numbers are shown on the Safety Compliance Certification Label. The label shall be affixed to either the door hinge pillar, door-latch post, or the door edge that meets the door-latch post, next to the driver's seating position. The total load on each axle must never exceed its GAWR.**

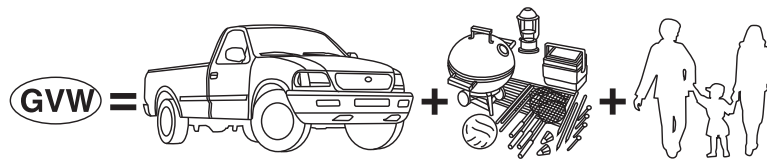

**GVW (Gross Vehicle Weight)** – is the Vehicle Curb Weight + cargo + passengers.

**GVWR (Gross Vehicle Weight Rating)** – is the maximum allowable weight of the fully loaded vehicle (including all options, equipment, passengers and cargo). **The GVWR is shown on the Safety Compliance Certification Label. The label shall be affixed to either the door hinge pillar, door-latch post, or the door edge that meets the door-latch post, next to the driver's seating position. The GVW must never exceed the GVWR.**

## Tires, Wheels and Loading

- Example only:

**MFD. BY FORD MOTOR CO.**

DATE: XX/XX GVWR: XXXXXLB/ XXXXXKG  
 FRONT GAWR: XXXXL REAR GAWR: XXXXLB  
 XXXXKG WITH XXXXKG WITH  
 XXXX/XXXXXX TIRES XXXX/XXXXXX TIRES  
 XXXX.XX RIMS XXXX.XX RIMS  
 AT XXX kPa/XX PSI COLD AT XXX kPa/XX PSI COLD

THIS VEHICLE CONFORMS TO ALL APPLICABLE FEDERAL MOTOR VEHICLE SAFETY STANDARDS IN EFFECT ON THE DATE OF MANUFACTURE SHOWN ABOVE.

VIN: XXXXXXXXXXXXXXXXXX XXXXX  
 TYPE: XXX XXXXX

XXXXXXXXXXXXXXXX XXX XXXX-XXXXXX-XX

EXT PNT: XX RC: XX DSO: \_\_\_\_\_  
 WB INT TR TP/PS R AXLE TR SPR XXXXX  
 XXX XX X XX X XX XXX  
 XXXXXXXXXXXXXXXXXX XXX XXXX-XXXXXX-XX

**MFD. BY FORD MOTOR CO.**

DATE: XX/XX GVWR/PNBV: XXXX LB/XXXXKG  
 FRONT GAWR/PNBE AY REAR GAWR/PNBE AR  
 XXXX/XXXXB XXXXKG/XXXXLB  
 WITH/AVEC TIRES/PNEUS  
 XXXX/XXXXXX  
 XXXX/XXXXXX  
 XXXXXX RIMS/JANTES XXXXXX

AT/A kPa/PSI/LPC XXX/XX COLD/A FROID XXX/XX  
 /JUMEELES

VIN: XXXXXXXXXXXXXXXXXX XXXXXX  
 TYPE: XXX/XXXX COMPLIES: XXXX/XXX - XXX XXXXXX  
 XXXXXX

XXXXXXXXXXXXXXXX XXX XXXX-XXXXXX-XX

EXT PNT: JJ RC: XX DSO: \_\_\_\_\_  
 WB INT TR TP/PS R AXLE TR SPR XXXXX  
 XXX XX X XX X XXXX XXX  
 XXXXXXXXXXXXXXXXXX XXX XXXX-XXXXXX-XX

 **WARNING:** Exceeding the Safety Compliance Certification Label vehicle weight rating limits could result in substandard vehicle handling or performance, engine, transmission and/or structural damage, serious damage to the vehicle, loss of control and personal injury.

 **WARNING:** Do not exceed the GVWR or the GAWR specified on the Safety Compliance Certification Label.

## Tires, Wheels and Loading



**WARNING:** Do not use replacement tires with lower load carrying capacities than the original tires because they may lower the vehicle's GVWR and GAWR limitations. Replacement tires with a higher limit than the original tires do not increase the GVWR and GAWR limitations.



**WARNING:** Exceeding any vehicle weight rating limitation could result in serious damage to the vehicle and/or personal injury.

### Steps for determining the correct load limit:

1. Locate the statement "The combined weight of occupants and cargo should never exceed XXX kg or XXX lbs." on your vehicle's placard.
2. Determine the combined weight of the driver and passengers that will be riding in your vehicle.
3. Subtract the combined weight of the driver and passengers from XXX kg or XXX lbs.
4. The resulting figure equals the available amount of cargo and luggage load capacity. For example, if the "XXX" amount equals 1,400 lbs. and there will be five 150 lb. passengers in your vehicle, the amount of available cargo and luggage load capacity is 650 lbs.  $(1400 - 750 (5 \times 150) = 650 \text{ lb.})$ . In metric units  $(635 - 340 (5 \times 68) = 295 \text{ kg.})$
5. Determine the combined weight of luggage and cargo being loaded on the vehicle. That weight may not safely exceed the available cargo and luggage load capacity calculated in Step 4.

The following gives you a few examples on how to calculate the available amount of cargo and luggage load capacity:

- Another example for your vehicle with 1400 lb. (635 kg) of cargo and luggage capacity. You decide to go golfing. Is there enough load capacity to carry you, 4 of your friends and all the golf bags? You and four friends average 220 lb. (99 kg) each and the golf bags weigh approximately 30 lb. (13.5 kg) each. The calculation would be:  $1400 - (5 \times 220) - (5 \times 30) = 1400 - 1100 - 150 = 150 \text{ lb.}$  Yes, you have enough load capacity in your vehicle to transport four friends and your golf bags. In metric units, the calculation would be:  $635 \text{ kg} - (5 \times 99 \text{ kg}) - (5 \times 13.5 \text{ kg}) = 635 - 495 - 67.5 = 72.5 \text{ kg.}$

## Tires, Wheels and Loading

- A final example for your vehicle with 1400 lb. (635 kg) of cargo and luggage capacity. You and one of your friends decide to pick up cement from the local home improvement store to finish that patio you have been planning for the past 2 years. Measuring the inside of the vehicle with the rear seat folded down, you have room for 12-100 lb. (45 kg) bags of cement. Do you have enough load capacity to transport the cement to your home? If you and your friend each weigh 220 lb. (99 kg), the calculation would be:  $1400 - (2 \times 220) - (12 \times 100) = 1400 - 440 - 1200 = -240$  lb. No, you do not have enough cargo capacity to carry that much weight. In metric units, the calculation would be:  $635 \text{ kg} - (2 \times 99 \text{ kg}) - (12 \times 45 \text{ kg}) = 635 - 198 - 540 = -103$  kg. You will need to reduce the load weight by at least 240 lb. (104 kg). If you remove 3-100 lb. (45 kg) cement bags, then the load calculation would be:

$1400 - (2 \times 220) - (9 \times 100) = 1400 - 440 - 900 = 60$  lb. Now you have the load capacity to transport the cement and your friend home. In metric units, the calculation would be:  $635 \text{ kg} - (2 \times 99 \text{ kg}) - (9 \times 45 \text{ kg}) = 635 - 198 - 405 = 32$  kg.

The above calculations also assume that the loads are positioned in your vehicle in a manner that does not overload the Front or the Rear Gross Axle Weight Rating specified for your vehicle on the Safety Compliance Certification Label. The label shall be affixed to either the door hinge pillar, door-latch post, or the door edge that meets the door-latch post, next to the driver's seating position.

### TRAILER TOWING



**WARNING:** Never tow a trailer with this vehicle. Your vehicle is not equipped to tow. No towing packages are available through an authorized dealer.

### RECREATIONAL TOWING

**Note:** Put your climate control system in recirculated air mode to prevent exhaust fumes from entering the vehicle. Refer to the *Climate Controls* chapter for more information.

**Note:** The vehicle must be towed in the forward position to ensure no damage is done to the internal transmission components. In addition, it is recommended that you follow the instructions provided by the aftermarket manufacturer of the towing equipment, if provided.

## Tires, Wheels and Loading

Follow these guidelines if you have a need for recreational (RV) towing. An example of recreational towing would be towing your vehicle behind a motor home. These guidelines are designed to ensure that your transmission is not damaged.

Before you tow your vehicle, follow these directions for your specific vehicle configuration **after** it is hooked-up to the RV or tow dolly:

### Vehicles with a Manual Transmission

1. Release the parking brake.
2. Move the gearshift to the neutral position.
  - The maximum towing speed is 70 mph (113 km/h).
  - There is no limitation on towing distance.

### Vehicles with an Automatic Transmission but No Push Button Start System

**Note:** There **must** be battery power to properly move the transmission's internal components to N (Neutral) in Step 3. Also, moving the gearshift to the N (Neutral) position without first turning the ignition to the on (II) position limits the towing capability to 35 mph (56 km/h) and 50 miles (80 km).

1. Release the parking brake.
2. Turn the ignition to the on (II) position.
3. Press the brake pedal, then move the gearshift to the N (Neutral) position.
4. Wait for TRANSMISSION READY to appear in the multi-function display, then turn the ignition to the off (0) position and release the brake pedal.
5. Disconnect the negative (black) cable from the battery. (The anti-theft system is disabled until the battery cable is reconnected.) Refer to *Battery* in the *Maintenance and Specifications* chapter when disconnecting and reconnecting the battery cable.
  - The maximum towing speed is 70 mph (113 km/h).
  - There is no limitation on towing distance.

When done towing, start the engine within 15 minutes of reconnecting the battery cable. When reconnecting that cable, tighten it until it's snug against the terminal; be careful not to overtighten.

## Tires, Wheels and Loading

### Vehicles with an Automatic Transmission and Push Button Start System

**Note:** There **must** be battery power to properly move the transmission's internal components to N (Neutral) in Step 3. Also, moving the gearshift to the N (Neutral) position without first turning the ignition to the on (II) position limits the towing capability to 35 mph (56 km/h) and 50 miles (80 km).

1. Release the parking brake.
2. Activate the ignition by pressing the START/STOP button, but **not** applying the brake pedal.
3. Press the brake pedal, then move the gearshift to the N (Neutral) position. Release the brake pedal.
4. Wait for TRANSMISSION READY to appear in the multi-function display, then deactivate the ignition by pressing the START/STOP button.
5. Disconnect the negative (black) cable from the battery. (The door key [inside the Intelligent Access Key] is needed to lock/unlock doors when the battery cable is disconnected. Also, the anti-theft system is disabled until the battery cable is reconnected.) Refer to *Battery* in the *Maintenance and Specifications* chapter when disconnecting and reconnecting the battery cable.
  - The maximum towing speed is 70 mph (113 km/h).
  - There is no limitation on towing distance.

When done towing, start the engine within 15 minutes of reconnecting the battery cable. When reconnecting that cable, tighten it until it's snug against the terminal; be careful not to overtighten.



### STARTING

#### Positions of the ignition

If your vehicle is equipped with a push button start system, refer to *Push button start system* in this section for ignition modes.

1. 0 (off) — locks the steering wheel, automatic transmission gearshift lever and allows key removal. This position also shuts the engine and all electrical accessories off.

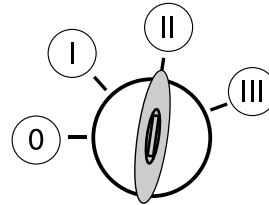

2. I (accessory) — allows the electrical accessories such as the radio to operate while the engine is not running.

3. II (on) — all electrical circuits operational. Warning lights illuminated. Key position when driving.

4. III (start) — cranks the engine. Release the key as soon as the engine starts.

**Note:** Do not store the key in the ignition after the vehicle is turned off and you have left the vehicle. This could cause a drain on the battery.

#### Preparing to start your vehicle

Engine starting is controlled by the powertrain control system.

This system meets all Canadian interference-causing equipment standard requirements regulating the impulse electrical field strength of radio noise.

When starting a fuel-injected engine, don't press the accelerator before or during starting. Only use the accelerator when you have difficulty starting the engine. For more information on starting the vehicle, refer to *Starting the engine* in this chapter.



**WARNING:** Extended idling at high engine speeds can produce very high temperatures in the engine and exhaust system, creating the risk of fire or other damage.



**WARNING:** Do not park, idle, or drive your vehicle in dry grass or other dry ground cover. The emission system heats up the engine compartment and exhaust system, which can start a fire.

## Driving

 **WARNING:** Do not start your vehicle in a closed garage or in other enclosed areas. Exhaust fumes can be toxic. Always open the garage door before you start the engine. See *Guarding against exhaust fumes* in this chapter for more instructions.

 **WARNING:** If you smell exhaust fumes inside your vehicle, have your dealer inspect your vehicle immediately. Do not drive if you smell exhaust fumes.

### **Important safety precautions**

When the engine starts, the idle RPM runs faster to warm the engine. If the engine idle speed does not slow down automatically, have the vehicle checked.

Before starting the vehicle:

1. Make sure all occupants buckle their safety belts. For more information on safety belts and their proper usage, refer to the *Seating and Safety Restraints* chapter.
2. Make sure the headlamps and electrical accessories are off.

If starting a vehicle with an automatic transmission:

- Make sure the parking brake is set.

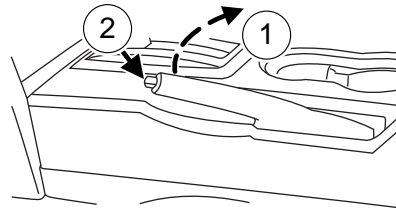

## Driving

- Make sure the gearshift is in P (Park).

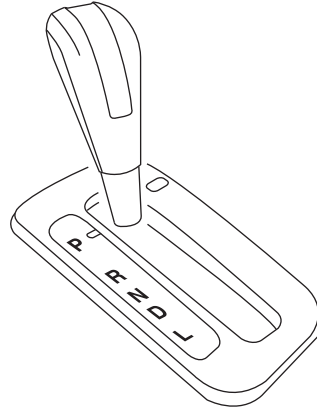

If starting a vehicle with a manual transmission:

- Make sure the parking brake is set.
- Press the clutch pedal to the floor.

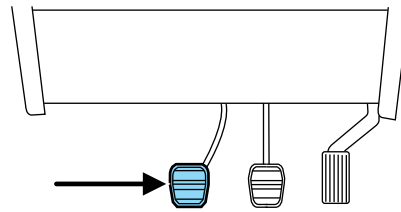

3. Turn the key to II (on) without turning the key to III (start).

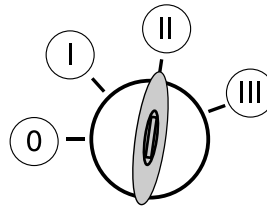

Some warning lights will briefly illuminate. See *Warning lights and indicators* in the *Instrument Cluster* chapter for more information regarding the warning lights.

## Driving

### Starting the engine

**Note:** If your vehicle is equipped with a push button start system, refer to *Push button start system* in this section for starting.

1. Turn the key to II (on) without turning the key to III (start).
2. Turn the key to III (start), then release the key as soon as the engine begins cranking. Your vehicle has a computer assisted cranking system that assists in starting the engine. After releasing the key from the III (start) position, the engine may continue cranking for up to 10 seconds or until the vehicle starts.

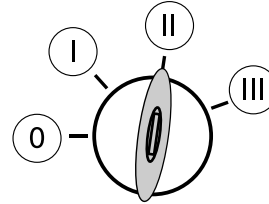

**Note:** Cranking may be stopped at any time by turning the key to the off position.

3. After idling for a few seconds, release the parking brake, apply the brake, shift into gear and drive.

**Note:** If the engine does not start on the first try, turn the vehicle to the off position, wait 10 seconds and try Step 2 again. If the engine still fails to start, press the accelerator to the floor and try Step 2 again, keeping the accelerator on the floor until the engine begins to accelerate above cranking speeds; this will allow the engine to crank with the fuel shut off in case the engine is flooded with fuel.

### Push button start system (if equipped)

If your vehicle is equipped with the push button start system, you can start your vehicle by pressing the start button in combination with the brake pedal (automatic transmission) or clutch pedal (manual transmission) rather than using a key. The start button is located on the instrument panel to the right of the steering wheel.

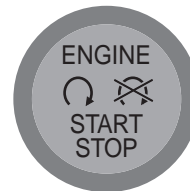

In order to operate the push button start system and start the vehicle, your intelligent access key (IA key) must be present inside the vehicle.

### Ignition modes

1. Off — press and release the START/STOP button without applying the brake pedal (automatic transmission) or clutch pedal (manual transmission) when your vehicle is in on mode or when the engine is running.

## Driving

2. On — press the START/STOP button without applying the brake pedal (automatic transmission) or clutch pedal (manual transmission). This will power your vehicle's electrical system and the warning lights in the instrument cluster will illuminate, but the engine will remain off.

3. Start — press the START/STOP button (for any length of time) while applying the brake pedal (automatic transmission) or clutch pedal (manual transmission). **Note:** The indicator light on the start button will illuminate when the vehicle is in on mode and when the engine is started.

There may be areas inside your vehicle where the IA key is not detected. If the message KEY NOT DETECTED appears on your multifunction display when you press the START/STOP button, it may be necessary to move your IA key to another area within the vehicle. The IA key may not be detected near the roof (between the driver or passenger sunvisor and the roof, or in the overhead console area) or in the extreme corners of the rear package tray, near your audio speakers. It is not recommended that you stow the IA key in these locations. If you move the IA key to a location where it has been detected before and you still see the KEY NOT DETECTED message, your IA key's battery may be low or you may be in an area with excessive radio frequency interference. If this occurs, you can use the backup method to start your vehicle (see below).

**Backup method of starting:** Your IA key uses a radio frequency signal to communicate with your vehicle and authorize your vehicle to start when you press the START/STOP button and apply the brake pedal or clutch pedal. If excessive radio frequency interference is present in the area, or if the battery in your IA key is low, it may be necessary to start your car by holding the IA key

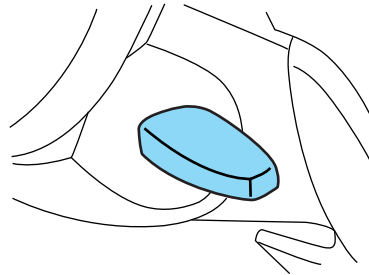

to the backup location near the steering column. After holding the IA key to the backup location, use the START/STOP button and brake pedal (automatic transmission) or clutch pedal (manual transmission) to start your vehicle as usual. The vehicle should respond normally as long as the IA key is at the backup location on the steering column. Once the vehicle is started, the IA key can be moved from the backup location, if desired.

## Driving

**Fast restart feature:** The fast restart feature allows you to re-start your vehicle within 10 seconds of switching the vehicle off, if a valid IA key is not present when the vehicle is switched off. You can re-start the vehicle (by applying the brake/clutch pedal and pressing the START/STOP button) for up to 10 seconds, even though the IA key is not present. After 10 seconds have expired, you can no longer start your vehicle without the IA key present inside the vehicle. If the driver door is opened within this 10 seconds, the fast restart timer expires immediately.

**Switching the vehicle off when not in P (Park):** It is recommended that you shift into the P (Park) position before switching your vehicle off. If you switch your vehicle off with the shifter in any position other than P (Park), the message SHIFT TO PARK will be displayed in the multifunction display. If the vehicle is left in this state, your key in ignition chime will activate when the driver door is opened, and you may drain your vehicle's battery. In order to avoid draining your battery, it is recommended that you always shift to P (Park) before or immediately after switching your vehicle off.

**Absence of the intelligent access key:** Once the vehicle has started, the vehicle will remain running until being turned off by the START/STOP button, even if the IA key is no longer found in the vehicle. Whenever a door is opened and then closed while the vehicle is running, the system will search for an IA key inside the vehicle and the multifunction display will display KEY OUTSIDE CAR if the IA key is no longer present. This message is a reminder that someone else in the vehicle may have taken the IA key when exiting the vehicle. If the IA key is no longer present in the vehicle, you will not be able to re-start your vehicle outside of the Fast Restart time (see *Fast Restart Feature* above). It is important to be aware of where your IA key is located in the vehicle, to avoid becoming stranded without an IA key.

### Guarding Against Exhaust Fumes



**WARNING:** If you smell exhaust fumes inside your vehicle, have this checked immediately. Do not drive your vehicle if you smell exhaust fumes. Carbon monoxide is present in exhaust fumes. Take precautions to avoid its dangerous effects.

### Important Ventilating Information

If you stop your vehicle and leave the engine idling for long periods of time, we recommend that you do one of the following:

- Open the windows at least 1 inch (2.5 cm).
- Set your climate control to outside air.

### ENGINE BLOCK HEATER (IF EQUIPPED)



**WARNING:** Failure to follow engine block heater instructions could result in property damage or physical injury.



**WARNING:** To reduce the risk of electrical shock, do not use your heater with ungrounded electrical systems or two-pronged (cheater) adapters.

An engine block heater warms the engine coolant which aids in starting and allows the heater/defroster system to respond quickly. If your vehicle is equipped with this system, your equipment includes a heater element which is installed in your engine block and a wire harness which allows the user to connect the system to a grounded 120 volt A/C electrical source. The block heater system is most effective when outdoor temperatures reach below 0°F (-18°C).

Prior to using the engine block heater, follow these recommendations for proper and safe operation:

- For your safety, use an outdoor extension cord that is product certified by Underwriter's Laboratory (UL) or Canadian Standards Association (CSA). Use only an extension cord that can be used outdoors, in cold temperatures, and is clearly marked "Suitable for Use with Outdoor Appliances." Never use an indoor extension cord outdoors; it could result in an electric shock or fire hazard.
- Use a 16-gauge outdoor extension cord, minimum.
- Use as short an extension cord as possible.
- Do not use multiple extension cords. Instead, use one extension cord which is long enough to reach from the engine block heater cord to the outlet without stretching.
- Make certain that the extension cord is in excellent condition (not patched or spliced). Store your extension cord indoors at temperatures above 32°F (0°C). Outdoor conditions can deteriorate extension cords over a period of time.
- To reduce the risk of electrical shock, do not use your heater with ungrounded electrical systems or two pronged (cheater) adapters. Also ensure that the block heater, especially the cord, is in good condition before use.
- Make sure that when in operation, the extension cord plug/engine block heater cord plug connection is free and clear of water in order to prevent possible shock or fire.

## Driving

- Be sure that areas where the vehicle is parked are clean and clear of all combustibles such as petroleum products, dust, rags, paper and similar items.
- Be sure that the engine block heater, heater cord and extension cord are solidly connected. A poor connection can cause the cord to become very hot and may result in an electrical shock or fire. Be sure to check for heat anywhere in the electrical hookup once the system has been operating for approximately a half hour.
- Finally, have the engine block heater system checked during your fall tune-up to be sure it's in good working order.

### How to use the engine block heater

Ensure the receptacle terminals are clean and dry prior to use. To clean them, use a dry cloth.

Depending on the type of factory installed equipment, your engine block heater will use .4 to 1.0 kilowatt-hours of energy per hour of use. Your factory installed block heater system does not have a thermostat; however, maximum temperature is attained after approximately three hours of operation. Block heater operation longer than three hours will not improve system performance and will unnecessarily use additional electricity.

Make sure system is unplugged and properly stowed before driving the vehicle. While not in use, make sure the protective cover seals the prongs of the engine block heater cord plug.

### BRAKES

Occasional brake noise is normal. If a metal-to-metal, continuous grinding or continuous squeal sound is present, the brake linings may be worn-out and should be inspected by an authorized dealer. If the vehicle has continuous vibration or shudder in the steering wheel while braking, the vehicle should be inspected by an authorized dealer.

Refer to *Warning lights and chimes* in the *Instrument Cluster* chapter for information on the brake system warning light.





Under normal operating conditions, brake dust may accumulate on the wheels. Some brake dust is inevitable as brakes wear and does not contribute to brake noise. The use of modern friction materials with emphasis on improved performance and environmental considerations can lead to more dust than in the past. Brake dust can be cleaned by weekly washing with soapy water and a soft sponge. Heavier deposits can be removed with Motorcraft® Wheel and Tire Cleaner. See the *Cleaning* chapter for more information.

### Four-wheel anti-lock brake system (ABS)

Your vehicle is equipped with an anti-lock braking system (ABS). This system helps you maintain steering control during emergency stops by keeping the brakes from locking. Noise from the ABS pump motor and brake pedal pulsation may be observed during ABS braking and the brake pedal may suddenly travel a little farther as soon as ABS braking is done and normal brake operation resumes. These are normal characteristics of the ABS and should be no reason for concern.

### Using ABS

When hard braking is required, apply continuous force on the brake pedal. Do not pump the brake pedal since this will reduce the effectiveness of the ABS and will increase your vehicle's stopping distance. The ABS will be activated immediately, allowing you to retain steering control during hard braking and on slippery surfaces. However, the ABS does not decrease stopping distance.

### ABS warning lamp

The ABS lamp in the instrument cluster momentarily illuminates when the ignition is turned on. If the light does not illuminate during start up, remains on or flashes, the ABS may be disabled and may need to be serviced.

Even when the ABS is disabled, normal braking is still effective. (If your BRAKE warning lamp illuminates with the parking brake released, have your brake system serviced immediately.)



## Driving

### Brake over accelerator

This vehicle is equipped with a brake over accelerator feature. In the event the accelerator pedal becomes stuck or entrapped, applying steady and firm pressure to the brake pedal will both slow the vehicle and reduce engine power. If you experience this condition, apply the brakes and bring your vehicle to a safe stop. Turn the engine off, shift to P (Park) and apply the parking brake, and then inspect the accelerator pedal for any interferences. If none are found and the condition persists, have your vehicle towed to the nearest authorized dealer.

### Parking brake

To set the parking brake (1), pull the parking brake handle up as far as possible.

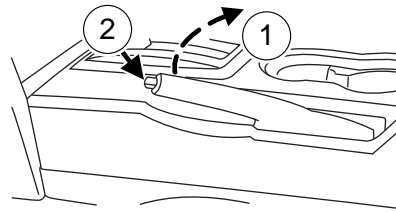

The BRAKE warning lamp will illuminate and will remain illuminated until the parking brake is released.

**BRAKE**



To release, press and hold the button (2), pull the handle up slightly, then push the handle down.



**WARNING:** Always set the parking brake fully and make sure that the gearshift is securely latched in P (Park) (automatic transmission) or in 1 (First) (manual transmission).



**WARNING:** If the parking brake is fully released, but the brake warning lamp remains illuminated, the brakes may not be working properly. See your authorized dealer as soon as possible.

## Driving

### ADVANCETRAC® STABILITY ENHANCEMENT SYSTEM

Your vehicle is equipped with the AdvanceTrac® system. The AdvanceTrac® system provides the following stability enhancement features for certain driving situations:

- Traction control system (TCS), which functions to help avoid drive-wheel spin and loss of traction.
- Electronic stability control (ESC), which functions to help avoid skids or lateral slides



**WARNING:** Vehicle modifications involving braking system, aftermarket roof racks, suspension, steering system, tire construction and/or wheel/tire size may change the handling characteristics of the vehicle and may adversely affect the performance of the AdvanceTrac® system. In addition, installing any stereo loudspeakers may interfere with and adversely affect the AdvanceTrac® system. Install any aftermarket stereo loudspeaker as far as possible from the front center console, the tunnel, and the front seats in order to minimize the risk of interfering with the AdvanceTrac® sensors. Reducing the effectiveness of the AdvanceTrac® system could lead to an increased risk of loss of vehicle control, vehicle rollover, personal injury and death.



**WARNING:** Remember that even advanced technology cannot defy the laws of physics. It's always possible to lose control of a vehicle due to inappropriate driver input for the conditions. Aggressive driving on any road condition can cause you to lose control of your vehicle increasing the risk of personal injury or property damage. Activation of the AdvanceTrac® system is an indication that at least some of the tires have exceeded their ability to grip the road; this could reduce the operator's ability to control the vehicle potentially resulting in a loss of vehicle control, vehicle rollover, personal injury and death. If your AdvanceTrac® system activates, SLOW DOWN.



**WARNING:** If a failure has been detected within the AdvanceTrac® system, the stability control light will illuminate steadily. Have the system serviced by an authorized dealer immediately.

The AdvanceTrac® system automatically enables each time the engine is started. All features of the AdvanceTrac® system (TCS and ESC) are active and monitor the vehicle from start-up. However, the system will only intervene if the driving situation requires it.

## Driving

The AdvanceTrac® system includes a stability control light and a stability control off light in the instrument cluster. Both the stability control light and the stability control off light in the instrument cluster will illuminate temporarily during start-up as part of a system self-check. The stability control light may illuminate during certain driving situations which may cause the AdvanceTrac® system to operate. If the stability control light illuminates steadily, have the system serviced by an authorized dealer immediately.

When AdvanceTrac® performs a normal system self-check, some drivers may notice a slight movement of the brake, and/or a rumble, grunting, or grinding noise after startup and when driving off.

When an event occurs that activates AdvanceTrac®, you may experience the following:

- A slight deceleration of the vehicle
- The stability control light will flash.
- A vibration in the pedal when your foot is on the brake pedal
- If the driving condition is severe and your foot is not on the brake, the brake pedal may move as the systems applies higher brake forces. You may also hear a whoosh of air from under the instrument panel during this severe condition.
- The brake pedal may feel stiffer than usual.

### **Traction control system (TCS)**

Traction control is a driver aid feature that helps your vehicle maintain traction of the wheels, typically when driving on slippery and/or hilly road surfaces, by detecting and controlling wheel spin.

Excessive wheel spin is controlled in two ways, which may work separately or in tandem, engine traction control and brake traction control. Engine traction control works to limit drive-wheel spin by momentarily reducing engine power. Brake traction control works to limit wheel spin by momentarily applying the brakes to the wheel that is slipping. Traction control is most active at low speeds.

During TCS events, the stability control light in the instrument cluster will flash.

If the TCS is activated excessively in a short period of time, the braking portion of the system may become temporarily disabled to allow the brakes to cool down. In this situation, TCS will use only engine power reduction or transfer to help control the wheels from over-spinning. When the brakes have cooled down, the system will regain all features.

Anti-lock braking, and ESC are not affected by this condition and will continue to function during the cool-down period.

### **Electronic stability control (ESC)**

Electronic stability control (ESC) may enhance your vehicle's directional stability during adverse maneuvers, for example when cornering severely or avoiding objects in the roadway. ESC operates by applying brakes to one or more of the wheels individually and, if necessary, reducing engine power if the system detects that the vehicle is about to skid or slide laterally.

During ESC events, the stability control light in the instrument cluster will flash.

Certain adverse driving maneuvers may activate the ESC system, which include but are not limited to:

- Taking a turn too fast
- Maneuvering quickly to avoid an accident, pedestrian or obstacle
- Driving over a patch of ice or other slippery surfaces
- Changing lanes on a snow-rutted road
- Entering a snow-free road from a snow-covered side street, or vice versa
- Entering a paved road from a gravel road, or vice versa

### **Switching off AdvanceTrac®/traction control**



If the vehicle is stuck in snow, mud or sand, and seems to lose engine power, switching off certain features of the AdvanceTrac® system may be beneficial because the wheels are allowed to spin. This will restore full engine power and will enhance momentum through the obstacle.

To disable the traction control system, do the following on the multifunction display:

1. Select Menu
2. Select Vehicle Settings
3. Select Traction Control
4. Select TCS OFF or uncheck
5. Select OK

See *Multifunction display* in the *Instrument Cluster* section for more information.

## Driving

AdvanceTrac® Features				
TCS switch in multi-function display	Stability control light 	Stability control off light 	ESC	TCS
Default at start-up	Illuminated during bulb check	Illuminated during bulb check	Enabled	Enabled
De-select TCS	Not illuminated	Illuminated solid	Enabled	Disabled
Select TCS again after deactivation	Not illuminated	Not illuminated	Enabled	Enabled

Full features of the AdvanceTrac® system can be restored by selecting TCS again or by turning off and restarting the engine.

If you switch off traction control, the traction control system will be de-activated in the multi-function display and the stability control off light will illuminate steadily. Selecting the AdvanceTrac® system again will turn off the stability control off light.

In R (Reverse), ABS and the engine and brake traction control features will continue to function; however, ESC is disabled.

### STEERING

Your vehicle is equipped with an Electric Power Steering (EPS) system. There is no fluid reservoir to check or fill.

If your vehicle loses electrical power while you are driving (or if the ignition is turned off), you can steer the vehicle manually, but it takes more effort. Under extreme usage conditions, the steering effort may increase. This occurs to prevent overheating and permanent damage to your steering system. If this should occur, you will neither lose the ability to steer the vehicle manually nor will it cause permanent damage.

Typical steering and driving maneuvers will allow the system to cool and steering assist will return to normal.

The EPS system has diagnostic checks that continuously monitor the EPS system to ensure proper operation. When a system error is detected, the following message STEERING MALFUNCTION SERVICE NOW, STEERING MALFUNCTION STOP SAFELY, POWER STEERING MALFUNCTION SERVICE NOW, POWER STEERING ASSIST FAULT

## Driving

may display in the multifunction display. Refer to the *Message center* in the *Instrument Cluster* chapter for more information.



**WARNING:** The EPS has diagnostics checks that continuously monitor the EPS to ensure proper operation of the electronic system. When an electronic error is detected, the message POWER STEERING ASSIST FAULT will be displayed in the message center. If this happens, stop the vehicle in a safe place and turn off the engine. After at least 10 seconds, reset the system by restarting the engine, and watch the message center for POWER STEERING ASSIST FAULT. If the message returns, or returns while driving, take the vehicle to your dealer to have it checked. With the message displayed, the steering assist is turned off, making the vehicle harder to steer.

If the steering wanders or pulls, check for:

- an improperly inflated tire.
- uneven tire wear.
- loose or worn suspension components.
- loose or worn steering components.
- improper steering alignment.

A high crown in the road or high crosswinds may also make the steering seem to wander/pull.

### Speed sensitive steering

The steering in your vehicle is speed sensitive. At lower speeds the assist is increased to improve maneuverability.

If the amount of effort required to steer your vehicle changes while driving at a constant vehicle speed, have the power steering system checked by your authorized dealer.

### BRAKE-SHIFT INTERLOCK

This vehicle is equipped with a brake-shift interlock feature that prevents the gearshift lever from being moved from P (Park) when the ignition is in the on position unless the brake pedal is pressed.

If you cannot move the gearshift lever out of P (Park) with ignition in the on position and the brake pedal pressed, it is possible that a fuse has blown or the vehicle's brake lamps are not operating properly. Refer to *Fuses and relays* in the *Roadside Emergencies* chapter.

## Driving

If the fuse is not blown and the brake lamps are working properly, the following procedure will allow you to move the gearshift lever from P (Park):

1. Apply the parking brake, turn the ignition key to the off position and remove the key.

2. Using a screwdriver (or similar tool), carefully pry off and remove the passenger side console cover to expose the inside of the shifter assembly.

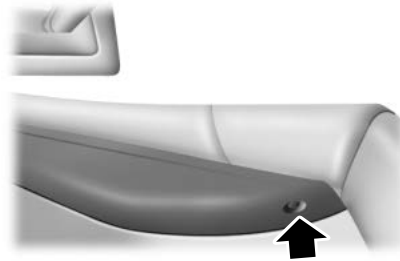

3. Locate the brake shift interlock lever on the passenger side of the shifter assembly.

4. Apply the brake pedal. Using a screwdriver (or similar tool), press and hold the brake shift interlock lever forward below the metal blade while pulling the gearshift lever out of the P (Park) position and into the N (Neutral) position.

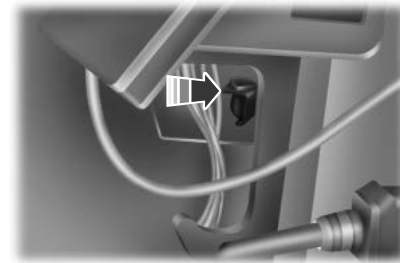

5. Install the console cover.

6. Apply the brake pedal, start the vehicle and release the parking brake.

**See your authorized dealer as soon as possible if this procedure is used.**



**WARNING:** Do not drive your vehicle until you verify that the brake lamps are working.



**WARNING:** When doing this procedure, you will be taking the vehicle out of park which means the vehicle can roll freely. To avoid unwanted vehicle movement, always fully set the parking brake prior to doing this procedure. Use wheel chocks if appropriate.





## Driving

 **WARNING:** If the parking brake is fully released, but the brake warning lamp remains illuminated, the brakes may not be working properly. See your authorized dealer.

### AUTOMATIC TRANSMISSION (IF EQUIPPED)

#### Understanding the gearshift positions of the 6-speed automatic transmission (if equipped)

 **WARNING:** Do not apply the brake pedal and accelerator pedal simultaneously. Applying both pedals simultaneously for more than three seconds will limit engine rpm, which may result in difficulty maintaining speed in traffic and could lead to serious injury.

 **WARNING:** Always set the parking brake fully and make sure the gearshift is latched in P (Park). Turn the ignition to the off position and remove the key whenever you leave your vehicle.

**Note:** The automatic transmission performs a series of automated checks when the ignition is turned to the off position. A slight clicking sound may be heard and is considered a normal part of operation.

#### **P (Park)**

This position locks the transmission and prevents the front wheels from turning.

To put your vehicle in gear:

- Press the brake pedal.
- Move the gearshift lever into the desired gear.

To put your vehicle in P (Park):

- Come to a complete stop.
- Move the gearshift lever and securely latch it in P (Park).



## Driving

### **R (Reverse)**

With the gearshift lever in R (Reverse), the vehicle will move backward. Always come to a complete stop before shifting into and out of R (Reverse).

### **N (Neutral)**

With the gearshift lever in N (Neutral), the vehicle can be started and is free to roll. Hold the brake pedal down while in this position.

### **D (Drive)**

The normal driving position for the best fuel economy. Transmission operates in gears one through six.

### **D (Drive) with Overdrive Cancel/Grade Assist**

Pressing the transmission control switch on the side of the gearshift lever activates overdrive cancel and grade assist.



Overdrive cancel/grade assist

- Overdrive is deactivated.
- The transmission operates in gears one through five.
- The grade assist lamp in the instrument cluster is illuminated.



- Improves driving in hilly terrain or mountainous areas by providing additional grade (engine) braking and extends lower gear operation on uphill climbs.
- Provides additional engine braking through the automatic transmission shift strategy which reacts to vehicle inputs (vehicle acceleration, accelerator pedal, brake pedal and vehicle speed).

## Driving

- Allows the transmission to select gears that will provide the desired engine braking based on the vehicle inputs mentioned above. This will increase engine RPM during engine braking.

Overdrive cancel with grade assist is designed to provide optimal gear selection in hilly terrain or mountainous areas. It is recommended that you return to D (Drive) on flat terrain to provide the best fuel economy and transmission function.

To return to D (Drive), press the transmission control switch again.

- The grade assist lamp in the instrument cluster will not be illuminated.
- The transmission will operate in gears one through five.

### **L (Low)**

This position:

- Provides maximum engine braking.
- Will downshift to the lowest available gear for the current vehicle speed; allows for first gear when vehicle reaches slower speeds.
- Is not intended for use under extended or normal driving conditions and results in lower fuel economy.

### **If Your Vehicle Gets Stuck in Mud or Snow**

**Note:** Do not rock the vehicle if the engine is not at normal operating temperature or damage to the transmission may occur.

**Note:** Do not rock the vehicle for more than a minute or damage to the transmission and tires may occur, or the engine may overheat.

If your vehicle gets stuck in mud or snow, it may be rocked out by shifting between forward and reverse gears, stopping between shifts in a steady pattern. Press lightly on the accelerator in each gear.

## Driving

### MANUAL TRANSMISSION OPERATION (IF EQUIPPED)

#### Using the clutch

Manual transmission vehicles have a starter interlock that prevents cranking the engine unless the clutch pedal is fully pressed.

To start the vehicle:

1. Make sure the parking brake is fully set.
2. Press the clutch pedal to the floor, then put the gearshift lever in the neutral position.
3. Start the engine.
4. Press the brake pedal and move the gearshift lever to the desired gear; 1 (First) or R (Reverse).

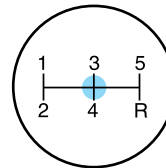

5. Release the parking brake, then slowly release the clutch pedal while slowly pressing on the accelerator.

During each shift, the clutch pedal must be fully pressed to the floor. Make sure the floor mat is properly positioned so it doesn't interfere with the full extension of the clutch pedal.

**Failure to fully press the clutch pedal to the floor may cause increased shift efforts, prematurely wear transmission components or damage the transmission.**

**Do not drive with your foot resting on the clutch pedal or use the clutch pedal to hold your vehicle at a standstill while waiting on a hill. These actions will severely reduce the life of the clutch and could nullify a clutch warranty claim.**

#### Recommended shift speeds

The engine is designed to operate at a minimum of 1250 RPM for optimal power, fuel economy, and durability. When driving a vehicle equipped with a manual transmission, do not operate the engine below 1250 RPM while driving with the transmission in any gear (also known as "lugging"). This does not apply while starting or idling the engine while the transmission is in neutral and/or the clutch pedal is pressed. Lugging the engine below 1250 RPM may result in damage to the vehicle powertrain, poor fuel economy, poor acceleration, and undesirable noise, vibration, and harshness. Choose the next lowest gear until a proper engine RPM is reached.

**Do not downshift into 1 (First) when your vehicle is moving faster than 15 mph (24 km/h). This will damage the clutch.**

## Driving

Upshift according to the following chart:

<b>Recommended upshifts (for best fuel economy) when accelerating</b>	
<b>5-speed manual transmission</b>	
Shift from:	
1 - 2	14 mph (23 km/h)
2 - 3	24 mph (39 km/h)
3 - 4	32 mph (51 km/h)
4 - 5	44 mph (71 km/h)

### Reverse

**Note:** Make sure that your vehicle is at a complete stop before you shift into R (Reverse). Failure to do so may damage the transmission.

**Note:** The gearshift lever can only be moved into R (Reverse) by moving it from left of 3 (Third) and 4 (Fourth) before shifting into R (Reverse). This is a lockout feature that protects the transmission from accidentally being shifted into R (Reverse) from 5 (Fifth).

Hold the clutch pedal down and move the gearshift lever into the neutral position. Shift into R (Reverse).

If R (Reverse) is not fully engaged, press the clutch pedal down and return the gearshift to the neutral position. Release the clutch pedal for a moment, then press it down and shift to R (Reverse) again.

### Parking your vehicle

1. Apply the brake and shift into the neutral position.
2. Fully apply the parking brake, hold the clutch pedal down, then shift into 1 (First).
3. Turn the ignition off.



**WARNING:** Do not park your vehicle in Neutral, it may move unexpectedly and injure someone. Use 1 (First) gear and set the parking brake fully.

## Driving

### HILL START ASSIST (HSA) SYSTEM (IF EQUIPPED)

The hill start assist (HSA) system makes it easier to pull away when the vehicle is on a slope without the need to use the parking brake. When HSA is active, the vehicle will remain stationary on the slope for two to three seconds after you release the brake pedal. During this time, you have time to move your foot from the brake to the accelerator pedal and pull away. The brakes are released automatically once the engine has developed sufficient drive to prevent the vehicle from rolling down the slope. This is an advantage when pulling away on a slope, (for example, from a car park ramp, traffic lights or while in reverse traveling uphill into a parking space).



**WARNING:** HSA does not replace the parking brake. When you leave the vehicle, always apply the parking brake and select P (Park) (automatic transmission) or neutral (manual transmission).

### Using HSA

The HSA system is activated automatically when the vehicle is stopped on a slope greater than four degrees. HSA operates with the vehicle facing downhill if reverse gear is selected.



**WARNING:** You must remain in the vehicle once you have activated HSA.



**WARNING:** During all times you are responsible for controlling the vehicle, supervising the HSA system and intervening, if required.

### Activating HSA

1. Press the brake pedal to bring the vehicle to a complete standstill. Keep the brake pedal pressed.
2. If the sensors detect that the vehicle is on a slope, the HSA system will be activated automatically.

3. When you remove your foot from the brake pedal, the vehicle will remain on the slope without rolling away for approximately two to three seconds. This hold time will automatically be extended if you are in the process of driving off.

4. Drive off in the normal manner. The brakes will be released automatically.

**Note:** If the engine is revved excessively, HSA will be deactivated.

### **Deactivating hill start assist**

To deactivate HSA, perform one of the following:

- Apply the parking brake.
- Drive off uphill without re-applying the brake.
- Wait for two to three seconds until the HSA system deactivates automatically.
- For automatic transmissions: If hill start assist is active in D (Drive), select R (Reverse). If hill start assist is active in R (Reverse), select N (Neutral).
- For manual transmissions: If a forward gear was selected when the system became active, select reverse gear. If reverse gear was selected when the system became active, select a forward gear.

**Note:** The HSA warning lamp (if equipped) in the instrument cluster momentarily illuminates when the ignition is turned on. If a



malfunction is detected in the HSA system, HSA will be deactivated and this warning lamp will appear on the instrument cluster.

## Driving

### BLIND SPOT MIRRORS

Blind spot mirrors have an integrated convex spotter mirror built into the upper outboard corner of the outside mirrors. They are designed to assist the driver by increasing visibility along the side of the vehicle. For more information on your side view mirrors, refer to *Exterior mirrors* in the *Driver Controls* chapter.

#### Driving with blind spot mirrors

Before a lane change, check the main mirror first, then check the blind spot mirror. If no vehicles are present in the blind spot mirror and the traffic in the adjacent lane is at a safe distance, signal that you are going to change lanes. Glance over your shoulder to verify traffic is clear, and carefully change lanes.

When the approaching vehicle is at a distance, its image is small and near the inboard edge of the main mirror. As the vehicle approaches, the image becomes larger and begins to move outboard across the main mirror (1). As the vehicle approaches its image will transition from the main mirror and begin to appear in the blind spot mirror (2). As the vehicle leaves the blind spot mirror it will transition to the driver's peripheral field of view (3).

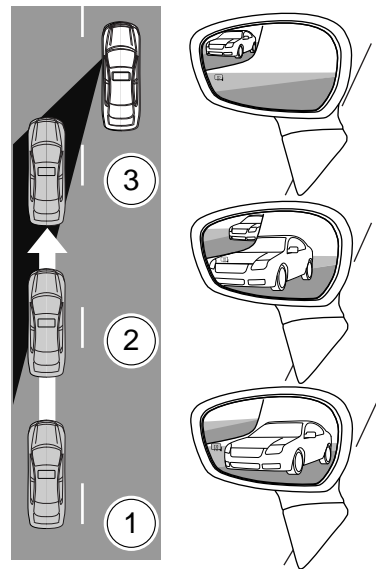

**WARNING:** Objects in the blind spot mirror are closer than they appear.



### DRIVING THROUGH WATER

If driving through deep or standing water is unavoidable, proceed very slowly. Never drive through water that is higher than the bottom of the wheel rims (for cars) or the bottom of the hubs (for trucks).

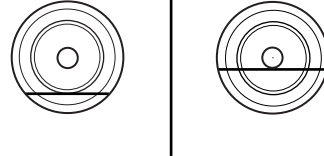

When driving through water, traction or brake capability may be limited. Also, water may enter your engine's air intake and severely damage your engine or your vehicle may stall. **Driving through deep water where the transmission vent tube is submerged may allow water into the transmission and cause internal transmission damage.**

**Once through the water, always dry the brakes by moving your vehicle slowly while applying light pressure on the brake pedal.** Wet brakes do not stop the vehicle as quickly as dry brakes.

## Roadside Emergencies

### ROADSIDE ASSISTANCE

#### Vehicles sold in the U.S. : Getting roadside assistance

To fully assist you should you have a vehicle concern, Ford Motor Company offers a complimentary roadside assistance program. This program is separate from the New Vehicle Limited Warranty. The service is available:

- 24-hours, seven days a week
- for the coverage period listed on the Roadside Assistance Card included in your Owner manual portfolio.

Roadside assistance will cover:

- a flat tire change with a good spare (except vehicles that have been supplied with a tire inflation kit)
- battery jump start
- lock-out assistance (key replacement cost is the customer's responsibility)
- fuel delivery – Independent Service Contractors, if not prohibited by state, local or municipal law shall deliver up to 2.0 gallons (7.5L) of gasoline or 5.0 gallons (18.9L) of diesel fuel to a disabled vehicle. Fuel delivery service is limited to two no-charge occurrences within a 12-month period.
- winch out – available within 100 feet (30.5 meters) of a paved or county maintained road, no recoveries.
- towing – Ford and Lincoln eligible vehicles towed to an authorized dealer within 35 miles (56 km) of the disablement location or to the nearest authorized dealer. If a member requests to be towed to an authorized dealer more than 35 miles (56 km) from the disablement location, the member shall be responsible for any mileage costs in excess of 35 miles (56 km).

Trailers shall be covered up to \$200 if the disabled eligible vehicle requires service at the nearest authorized dealer. If the trailer is disabled, but the towing vehicle is operational, the trailer does not qualify for any roadside services.

## Roadside Emergencies

### Vehicles sold in the U.S. : Using roadside assistance

Complete the roadside assistance identification card and place it in your wallet for quick reference. This card is found in the owner's information portfolio in the glove compartment.

U.S. Ford vehicle customers who require Roadside Assistance, call 1-800-241-3673.

If you need to arrange roadside assistance for yourself, Ford Motor Company will reimburse a reasonable amount for towing to the nearest dealership within 35 miles (56 km). To obtain reimbursement information, U.S. Ford vehicle customers call 1-800-241-3673. Customers will be asked to submit their original receipts.

### Vehicles sold in Canada : Getting roadside assistance

Canadian customers who require roadside assistance, call 1-800-665-2006.

### Vehicles sold in Canada : Using roadside assistance

Complete the roadside assistance identification card and place it in your wallet for quick reference. In Canada, the card is found in the Warranty Guide in the glove box.

Canadian Roadside coverage and benefits may differ from the U.S. coverage. Please refer to your Warranty Guide or visit our website at [www.ford.ca](http://www.ford.ca) for information on Canadian services and benefits.

Canadian customers who need to obtain roadside information, call 1-800-665-2006 or visit our website at [www.ford.ca](http://www.ford.ca).

## HAZARD FLASHER CONTROL

The hazard flasher control is located on the instrument panel by the radio. The hazard flashers will operate when the ignition is in any position or if the key is not in the ignition.



- Press the flasher control and all front and rear direction signals will flash.
- Press the flasher control again to turn them off.

Use it when your vehicle is disabled and is creating a safety hazard for other motorists.

**Note:** With extended use, the flasher may run down your battery.

## Roadside Emergencies

### FUEL PUMP SHUT-OFF

In the event of a moderate to severe collision, this vehicle is equipped with a fuel pump shut-off feature that stops the flow of fuel to the engine. Not every impact will cause a shut-off.

Should your vehicle shut off after a collision due to this feature, you may restart your vehicle by doing the following:

1. Turn the ignition switch to the off position.
2. Turn the ignition switch to the on position.

In some instances the vehicle may not restart the first time you try to restart and may take one additional attempt.



**WARNING:** Failure to inspect and if necessary repair fuel leaks after a collision may increase the risk of fire and serious injury. Ford Motor Company recommends that the fuel system be inspected by an authorized dealer after any collision.

### FUSES AND RELAYS

#### Fuses

If electrical components in the vehicle are not working, a fuse may have blown. Blown fuses are identified by a broken wire within the fuse. Check the appropriate fuses before replacing any electrical components.

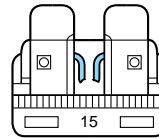

**Note:** Always replace a fuse with one that has the specified amperage rating. Using a fuse with a higher amperage rating can cause severe wire damage and could start a fire.

## Roadside Emergencies

### Standard fuse amperage rating and color

COLOR					
Fuse rating	Mini fuses	Standard fuses	Maxi fuses	Cartridge maxi fuses	Fuse link cartridge
2A	Grey	Grey	—	—	—
3A	Violet	Violet	—	—	—
4A	Pink	Pink	—	—	—
5A	Tan	Tan	—	—	—
7.5A	Brown	Brown	—	—	—
10A	Red	Red	—	—	—
15A	Blue	Blue	—	—	—
20A	Yellow	Yellow	Yellow	Blue	Blue
25A	Natural	Natural	—	Natural	Natural
30A	Green	Green	Green	Pink	Pink
40A	—	—	Orange	Green	Green
50A	—	—	Red	Red	Red
60A	—	—	Blue	Yellow	Yellow
70A	—	—	Tan	—	Brown
80A	—	—	Natural	Black	Black

### Passenger compartment fuse panel

The fuse panel is located behind the glove box. Open the glove box, press the sides inward and swing the glove box down.

## Roadside Emergencies

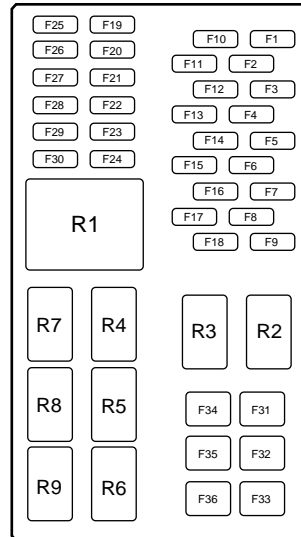

The fuses are coded as follows:

Fuse/Relay Location	Fuse Amp Rating	Protected circuits
F1	15A	Ignition switch, Keyless entry ignition relay, Keyless entry accessory relay
F2	10A	Electronic mirror, A/C clutch, Engine compartment fuse panel
F3	7.5A	Instrument cluster
F4	7.5A	Passenger airbag deactivation indicator, Occupant classification system
F5	15A	Diagnostic connector
F6	10A	Backup lamp
F7	7.5A	Instrument panel display, Intelligent access (IA) antenna, Manual climate controls
F8	7.5A	Front dome lamp, Moon roof switch

## Roadside Emergencies

Fuse/Relay Location	Fuse Amp Rating	Protected circuits
F9	20A	Keyless vehicle module
F10	15A	Radio, SYNC® module, Global positioning system (GPS) module
F11	20A	Front wipers, Body control module (BCM)
F12	20A	Tire pressure monitoring system (TPMS)
F13	15A	Rear wiper, BCM
F14	20A	IA module
F15	15A	Wiper switch
F16	7.5A	Power mirror switch, Driver window switch
F17	7.5A	Heated seats (early build)
	15A	Heated seats (late build)
F18	10A	Stop lamps, Turn signals
F19	7.5A	Instrument cluster
F20	10A	Airbag module
F21	10A	BCM, Climate control, Passive anti-theft system transceiver, Electronic power steering module, Instrument cluster, Engine compartment fuse panel
F22	7.5A	Accelerator pedal position sensor, Powertrain control module (PCM), Gear shifter, Anti-lock brake system (ABS) ignition feed
F23	10A	Transmission control unit ignition feed, TPMS ignition feed
F24	—	Not used
F25	7.5A	Exterior mirrors
F26	7.5A	TPMS
F27	—	Not used
F28	—	Not used
F29	—	Not used
F30	—	Not used

## Roadside Emergencies

Fuse/Relay Location	Fuse Amp Rating	Protected circuits
F31	30A	Driver and rear power window switches
F32	20A	Passenger compartment fuse panel battery saver relay
F33	20A	Power points
F34	30A	Driver and passenger power window switches
F35	20A	Moon roof
F36	—	Not used
R1	—	Ignition relay
R2	—	Left rear stop/turn lamp relay
R3	—	Right rear stop/turn lamp relay
R4	—	Driver heated seat relay
R5	—	Passenger heated seat relay
R6	—	IA module – accessory relay
R7	—	IA module – ignition relay
R8	—	Battery saver relay, Rear power points
R9	—	Not used

### Power distribution box

The power distribution box is located in the engine compartment. The power distribution box contains high-current fuses that protect your vehicle's main electrical systems from overloads.



**WARNING:** Always disconnect the battery before servicing high current fuses.



**WARNING:** To reduce risk of electrical shock, always replace the cover to the power distribution box before reconnecting the battery or refilling fluid reservoirs.



## Roadside Emergencies

If the battery has been disconnected and reconnected, refer to the *Battery* section of the *Maintenance and Specifications* chapter.

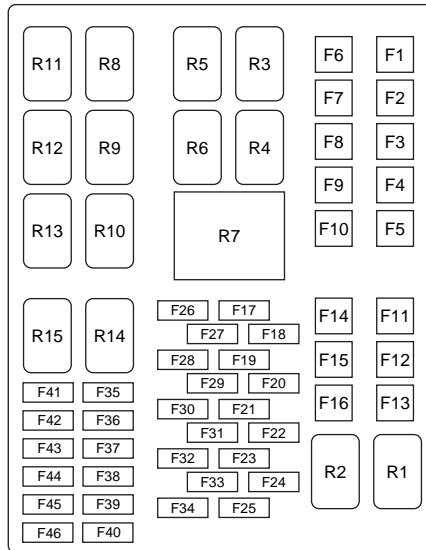

The high-current fuses are coded as follows:

Fuse/Relay Location	Fuse Amp Rating	Protected circuits
F1	40A*	Anti-lock brake system (ABS) pump
F2	50A*	Transmission control module (TCM)
F3	40A*	Engine cooling fan relay and motor
F4	40A*	Heater blower relay and motor
F5	60A*	Passenger compartment fuse panel
F6	30A*	Body control module (BCM) – door locks
F7	60A*	Passenger compartment fuse panel
F8	40A*	Powertrain control module (PCM), Power distribution box
F9	20A*	ABS module valve

## Roadside Emergencies

Fuse/Relay Location	Fuse Amp Rating	Protected circuits
F10	30A*	Starter inhibit relay, Starter motor
F11	30A*	Electronic fuel pump relay, Fuel tank, Ignition coil
F12	—	Not used
F13	—	Not used
F14	—	Not used
F15	—	Not used
F16	—	Not used
F17	20A**	High beam relay
F18	—	Not used
F19	20A**	Low beam relay
F20	15A**	Heated exhaust gas oxygen sensor, Catalyst module sensor
F21	7.5A**	Low and High beams coil relay control
F22	15A**	Mass air flow (MAF) sensor, Powertrain control module (PCM), Fuel injectors, Vehicle speed sensor (VSS), Variable camshaft timing, Canister purge
F23	15A**	Daytime running lights
F24	—	Not used
F25	15A**	BCM – exterior lighting
F26	20A**	BCM – battery saver, horn
F27	—	Not used
F28	15A**	BCM – turn signals
F29	—	Not used
F30	10A**	A/C clutch solenoid and relay
F31	—	Not used
F32	7.5A**	TCM, PCM
F33	15A**	Ignition coil
F34	30A**	BCM – rear window defroster

## Roadside Emergencies

Fuse/Relay Location	Fuse Amp Rating	Protected circuits
F35	10A**	Left headlamp (low beam)
F36	10A**	Right headlamp (low beam)
F37	10A**	Left headlamp (high beam)
F38	10A**	Right headlamp (high beam)
F39	2A**	Natural vacuum leak detection
F40	—	Not used
F41	—	Not used
F42	—	Not used
F43	—	Not used
F44	—	Not used
F45	—	Not used
F46	—	Not used
R1	—	Not used
R2	—	Not used
R3	—	PCM relay
R4	—	Heater blower relay
R5	—	Engine cooling fan relay
R6	—	A/C clutch relay
R7	—	Not used
R8	—	Daytime running lamp
R9	—	Starter inhibit relay
R10	—	High beam relay
R11	—	Low beam relay
R12	—	Reverse lamp relay
R13	—	Not used
R14	—	Not used
R15	—	Not used

\*Cartridge fuses \*\*Mini fuses

## Roadside Emergencies

### CHANGING THE TIRES

If you get a flat tire while driving, do not apply the brake heavily. Instead, gradually decrease your speed. Hold the steering wheel firmly and slowly move to a safe place on the side of the road.

**Note:** The tire pressure monitoring system (TPMS) indicator light will illuminate when the spare tire is in use. To restore the full functionality of the monitoring system, all road wheels equipped with tire pressure monitoring sensors must be mounted on the vehicle.

Have a flat serviced by an authorized dealer in order to prevent damage to the TPMS sensors, refer to *Tire pressure monitoring system (TPMS)* in the *Tires, Wheels and Loading* chapter. Replace the spare tire with a road tire as soon as possible. During repairing or replacing of the flat tire, have the authorized dealer inspect the TPMS sensor for damage.



**WARNING:** The use of tire sealants may damage your tire pressure monitoring system (TPMS) and should not be used. However, if you must use a sealant, the TPMS sensor and valve stem on the wheel must be replaced by an authorized Ford dealer.



**WARNING:** Refer to *Tire pressure monitoring system (TPMS)* in the *Tires, Wheels and Loading* chapter for important information. If the tire pressure monitor sensor becomes damaged, it will no longer function.

### Dissimilar spare tire/wheel information



**WARNING:** Failure to follow these guidelines could result in an increased risk of loss of vehicle control, injury or death.

If you have a dissimilar spare tire/wheel, then it is intended for temporary use only. This means that if you need to use it, you should replace it as soon as possible with a road tire/wheel that is the same size and type as the road tires and wheels that were originally provided by Ford. If the dissimilar spare tire or wheel is damaged, it should be replaced rather than repaired.

A dissimilar spare tire/wheel is defined as a spare tire and/or wheel that is different in brand, size or appearance from the road tires and wheels and can be one of three types:

1. **T-type mini-spare:** This spare tire begins with the letter “T” for tire size and may have “Temporary Use Only” molded in the sidewall

## Roadside Emergencies

**2. Full-size dissimilar spare with label on wheel:** This spare tire has a label on the wheel that states: "THIS TIRE AND WHEEL FOR TEMPORARY USE ONLY"

When driving with one of the dissimilar spare tires listed above, **do not:**

- Exceed 50 mph (80 km/h)
- Load the vehicle beyond maximum vehicle load rating listed on the Safety Compliance Label
- Tow a trailer
- Use snow chains on the end of the vehicle with the dissimilar spare tire
- Use more than one dissimilar spare tire at a time
- Use commercial car washing equipment
- Try to repair the dissimilar spare tire

Use of one of the dissimilar spare tires listed above at any one wheel location can lead to impairment of the following:

- Handling, stability and braking performance
- Comfort and noise
- Ground clearance and parking at curbs
- Winter weather driving capability
- Wet weather driving capability
- All-wheel driving capability (if applicable)

**3. Full-size dissimilar spare without label on wheel**

When driving with the full-size dissimilar spare tire/wheel, **do not:**

- Exceed 70 mph (113 km/h)
- Use more than one dissimilar spare tire/wheel at a time
- Use commercial car washing equipment
- Use snow chains on the end of the vehicle with the dissimilar spare tire/wheel

The usage of a full-size dissimilar spare tire/wheel can lead to impairment of the following:

- Handling, stability and braking performance
- Comfort and noise
- Ground clearance and parking at curbs

## Roadside Emergencies

- Winter weather driving capability
- Wet weather driving capability
- All-wheel driving capability (if applicable)
- Load leveling adjustment (if applicable)

When driving with the full-size dissimilar spare tire/wheel additional caution should be given to:

- Towing a trailer
- Driving vehicles equipped with a camper body
- Driving vehicles with a load on the cargo rack

Drive cautiously when using a full-size dissimilar spare tire/wheel and seek service as soon as possible.

### Stopping and securing the vehicle

1. Park on a level surface, set the parking brake and activate the hazard flashers.

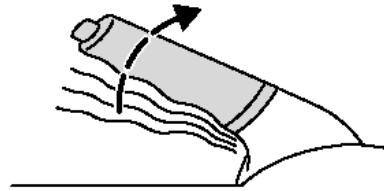

2. Place the gearshift lever in P (Park) (automatic transmission) or R (Reverse) (manual transmission) and turn the engine off.

### Tire change procedure



**WARNING:** When one of the front wheels is off the ground, the transmission alone will not prevent the vehicle from moving or slipping off the jack, even if the vehicle is in P (Park) (automatic transmission) or R (Reverse) (manual transmission).



**WARNING:** To help prevent the vehicle from moving when you change a tire, be sure the parking brake is set, then block (in both directions) the wheel that is diagonally opposite (other side and end of the vehicle) to the tire being changed.

## Roadside Emergencies



**WARNING:** If the vehicle slips off the jack, you or someone else could be seriously injured.



**WARNING:** Do not attempt to change a tire on the side of the vehicle close to moving traffic. Pull far enough off the road to avoid the danger of being hit when operating the jack or changing the wheel.

**Note:** Passengers should not remain in the vehicle when the vehicle is being jacked.

1. Remove the spare tire and jack by turning their tie-down bolts counterclockwise. The lug wrench is located in a bag next to, or on top of, the spare tire.

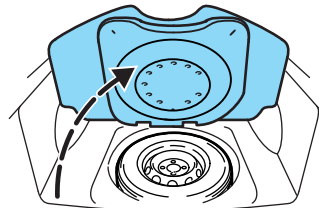

2. Block the diagonally opposite wheel.

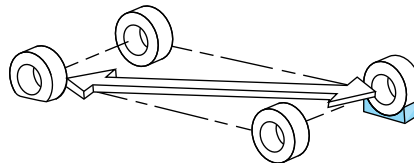

3. Loosen each wheel lug nut one-half turn counterclockwise but do not remove them until the wheel is raised off the ground.

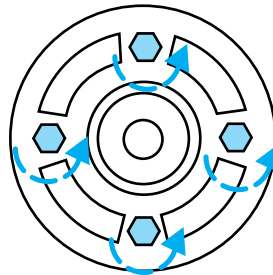

## Roadside Emergencies

4. The vehicle jacking points are located inward of the wheels.



 **WARNING:** To lessen the risk of personal injury, do not put any part of your body under the vehicle while changing a tire. Do not start the engine when your vehicle is on the jack. The jack is only meant for changing the tire.

5. Position the jack in the indentions on the sill next to the tire you are changing. Turn the jack handle clockwise until the tire is off the ground.



6. Remove the lug nuts with the lug wrench.

7. Replace the flat tire with the spare tire, making sure the valve stem is facing outward. Reinstall the lug nuts until the wheel is snug against the hub. Do not fully tighten the lug nuts until the wheel has been lowered.

8. Lower the wheel by turning the jack handle counterclockwise.

9. Remove the jack and fully tighten the lug nuts in the order shown. Refer to *Wheel lug nut torque specifications* later in this chapter for the proper lug nut torque specification.

10. Put the flat tire, jack and lug wrench away. Make sure the jack is fastened so it does not rattle when you drive. Unblock the wheels.

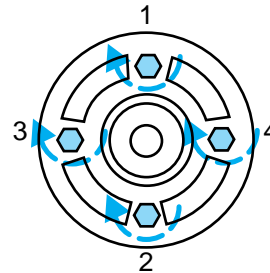



## Roadside Emergencies

### WHEEL LUG NUT TORQUE SPECIFICATIONS

Retighten the lug nuts to the specified torque within 100 miles (160 km) after any wheel disturbance (tire rotation, changing a flat tire, wheel removal, etc.).

Bolt size	Wheel lug nut torque*	
	ft-lb	N•m
M12 x 1.5	100	135

\* Torque specifications are for nut and bolt threads free of dirt and rust. Use only Ford recommended replacement fasteners.

 **WARNING:** When a wheel is installed, always remove any corrosion, dirt or foreign materials present on the mounting surfaces of the wheel or the surface of the wheel hub, brake drum or brake disc that contacts the wheel. Ensure that any fasteners that attach the rotor to the hub are secured so they do not interfere with the mounting surfaces of the wheel. Installing wheels without correct metal-to-metal contact at the wheel mounting surfaces can cause the wheel nuts to loosen and the wheel to come off while the vehicle is in motion, resulting in loss of control.

**Note:** Inspect the wheel pilot bore (1) and mounting surface prior to installation. Remove any visible corrosion or loose particles.

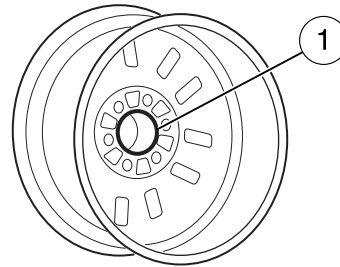

### RUNNING OUT OF FUEL

If you have run out of fuel and need to refill the vehicle with a portable fuel container, see *Running out of fuel* in the *Maintenance and Specifications* chapter for proper fuel filling method using a portable fuel container and the included fuel filler funnel. **Do not** insert the nozzle of portable fuel containers or any type of aftermarket funnels into the Easy Fuel® “no cap” fuel system as it can be damaged. You must use the included funnel in such circumstances.

## Roadside Emergencies

 **WARNING:** Do not insert the nozzle of portable fuel containers or aftermarket funnels into the Easy Fuel® system. This could damage the fuel system and its seal, and may cause fuel to run onto the ground instead of filling the tank, all of which could result in serious personal injury.

### JUMP STARTING

 **WARNING:** The gases around the battery can explode if exposed to flames, sparks, or lit cigarettes. An explosion could result in injury or vehicle damage.

 **WARNING:** Batteries contain sulfuric acid which can burn skin, eyes and clothing, if contacted.

Do not attempt to push-start your automatic transmission vehicle. Automatic transmissions do not have push-start capability. Attempting to push-start a vehicle with an automatic transmission may cause transmission damage.

### Preparing your vehicle

When the battery is disconnected or a new battery is installed, the automatic transmission must relearn its shift strategy. As a result, the transmission may have firm and/or soft shifts. This operation is considered normal and will not affect function or durability of the transmission. Over time, the adaptive learning process will fully update transmission operation.

1. **Use only a 12-volt supply to start your vehicle.**
2. Do not disconnect the battery of the disabled vehicle as this could damage the vehicle's electrical system.
3. Park the booster vehicle close to the hood of the disabled vehicle making sure the two vehicles **do not** touch. Set the parking brake on both vehicles and stay clear of the engine cooling fan and other moving parts.
4. Check all battery terminals and remove any excessive corrosion before you attach the battery cables. Ensure that vent caps are tight and level.
5. Turn the heater fan on in both vehicles to protect from any electrical surges. Turn all other accessories off.

## Roadside Emergencies

### Connecting the jumper cables

**Note:** In the illustration, the vehicle on the bottom is used to designate the assisting (boosting) battery.

1. Connect the positive (+) jumper cable to the positive (+) terminal of the discharged battery.
2. Connect the other end of the positive (+) cable to the positive (+) terminal of the assisting battery.
3. Connect the negative (-) cable to the negative (-) terminal of the assisting battery.
4. Make the final connection of the negative (-) cable to an exposed metal part of the stalled vehicle's engine, away from the battery and the carburetor/fuel injection system.

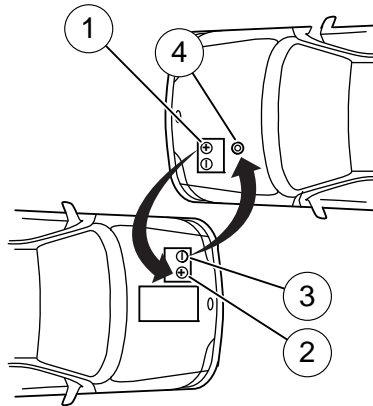

**Note:** Do not attach the negative (-) cable to fuel lines, engine rocker covers, the intake manifold or electrical components as grounding points.

**WARNING:** Do not connect the end of the second cable to the negative (-) terminal of the battery to be jumped. A spark may cause an explosion of the gases that surround the battery.

Ensure that the cables are clear of fan blades, belts, moving parts of both engines, or any fuel delivery system parts.

## Roadside Emergencies

### Jump Starting

1. Start the engine of the booster vehicle and run the engine at moderately increased speed.
2. Start the engine of the disabled vehicle.
3. Once the disabled vehicle has been started, run both engines for an additional three minutes before disconnecting the jumper cables.

### Removing the jumper cables

Remove the jumper cables in the reverse order that they were connected.

**Note:** In the illustration, the vehicle on the bottom is used to designate the assisting (boosting) battery.

1. Remove the jumper cable from the ground metal surface.
2. Remove the jumper cable on the negative (-) terminal of the booster vehicle's battery.
3. Remove the jumper cable from the positive (+) terminal of the booster vehicle's battery.
4. Remove the jumper cable from the positive (+) terminal of the disabled vehicle's battery.

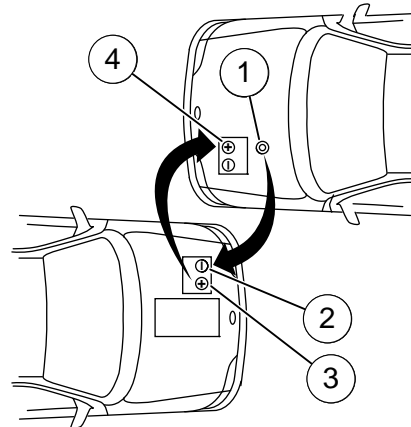

After the disabled vehicle has been started and the jumper cables removed, allow it to idle for several minutes so the engine computer can relearn its idle conditions.

## Roadside Emergencies

### WRECKER TOWING

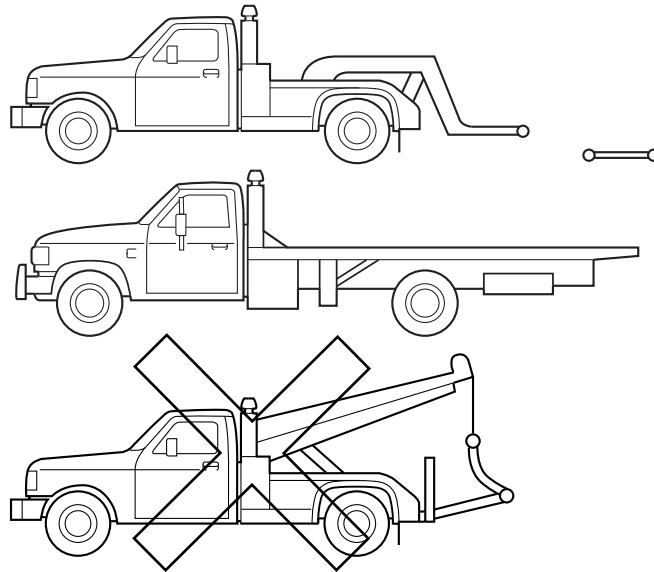

If you need to have your vehicle towed, contact a professional towing service or, if you are a member of a roadside assistance program, your roadside assistance service provider.

It is recommended that your vehicle be towed with a wheel lift and dollies or flatbed equipment. Do not tow with a slingbelt. Ford Motor Company has not approved a slingbelt towing procedure.

**If the vehicle is towed by other means or incorrectly, vehicle damage may occur.**

Ford Motor Company produces a towing manual for all authorized tow truck operators. Have your tow truck operator refer to this manual for proper hook-up and towing procedures for your vehicle.

**Note:** If your vehicle is to be towed from the rear using wheel lift equipment, the front wheels (drive wheels) must be placed on a dolly to prevent damage to the transmission.

**Note:** If your vehicle is to be towed from the front using wheel lift equipment, it is recommended that the rear wheels be placed on a dolly to prevent damage to the rear fascia.

## Roadside Emergencies

### Emergency towing

In case of a roadside emergency with a disabled vehicle (without access to wheel dollies, car hauling trailer, or flatbed transport vehicle) your vehicle (regardless of transmission powertrain configuration) can be flat towed (all wheels on the ground) under the following conditions:

- Vehicle is facing forward so that it is being towed in a forward direction.
- Place the transmission in N (Neutral). Refer to *Brake-shift interlock* in the *Driving* chapter for specific instructions if you cannot move the gear shift lever into N (Neutral).
- Maximum speed is not to exceed 35 mph (56 km/h).
- Maximum distance is 50 miles (80 km).

## Customer Assistance

### GETTING THE SERVICES YOU NEED

Warranty repairs to your vehicle must be performed by an authorized dealer. While any authorized dealer handling your vehicle line will provide warranty service, we recommend you return to your selling authorized dealer who wants to ensure your continued satisfaction.

Please note that certain warranty repairs require special training, equipment or both, so not all authorized dealers are authorized to perform all warranty repairs. This means that, depending on the warranty repair needed, you may have to take your vehicle to another authorized dealer.

A reasonable time must be allowed to perform a repair after taking your vehicle to the authorized dealer. Repairs will be made using Ford or Motorcraft parts, or remanufactured or other parts that are authorized by Ford.

### Away from home

If you are away from home when your vehicle needs service, contact the Ford Customer Relationship Center or use the online resources listed below to find the nearest authorized dealer.

In the United States:

#### **Mailing address**

Ford Motor Company  
Customer Relationship Center  
P.O. Box 6248  
Dearborn, MI 48121

#### **Telephone**

1-800-392-3673 (FORD)  
(TDD for the hearing impaired: 1-800-232-5952)

#### **Online**

Additional information and resources are available online at [www.fordowner.com](http://www.fordowner.com)

These are some of the items that can be found online:

- U.S. dealer locator by Dealer Name, City/State, or Zip Code
- Owner Guides
- Maintenance Schedules
- Recalls
- Ford Extended Service Plans
- Ford Genuine Accessories
- Service specials and promotions.

<https://www.MyCarManual.com>

279

## Customer Assistance

In Canada:

### **Mailing address**

Customer Relationship Centre  
Ford Motor Company of Canada, Limited  
P.O. Box 2000  
Oakville, Ontario L6J 5E4

### **Telephone**

1-800-565-3673 (FORD)

### **Online**

[www.ford.ca](http://www.ford.ca)

### **Additional assistance**

If you have questions or concerns, or are unsatisfied with the service you are receiving, follow these steps:

1. Contact your Sales Representative or Service Advisor at your selling/servicing authorized dealer.
2. If your inquiry or concern remains unresolved, contact the Sales Manager, Service Manager or Customer Relations Manager.
3. If you require assistance or clarification on Ford Motor Company policies, please contact the Ford Customer Relationship Center

In order to help you serve you better, please have the following information available when contacting a Customer Relationship Center:

- Vehicle Identification Number (VIN)
- Your telephone number (home and business)
- The name of the authorized dealer and city where located
- The vehicle's current odometer reading

In some states, you must directly notify Ford in writing before pursuing remedies under your state's warranty laws. Ford is also allowed a final repair attempt in some states.

In the United States, a warranty dispute must be submitted to the BBB AUTO LINE before taking action under the Magnuson-Moss Warranty Act, or to the extent allowed by state law, before pursuing replacement or repurchase remedies provided by certain state laws. This dispute handling procedure is not required prior to enforcing state created rights or other rights which are independent of the Magnuson-Moss Warranty Act or state replacement or repurchase laws.



## Customer Assistance

### IN CALIFORNIA (U.S. ONLY)

California Civil Code Section 1793.2(d) requires that, if a manufacturer or its representative is unable to repair a motor vehicle to conform to the vehicle's applicable express warranty after a reasonable number of attempts, the manufacturer shall be required to either replace the vehicle with one substantially identical or repurchase the vehicle and reimburse the buyer in an amount equal to the actual price paid or payable by the consumer (less a reasonable allowance for consumer use). The consumer has the right to choose whether to receive a refund or replacement vehicle.

California Civil Code Section 1793.22(b) presumes that the manufacturer has had a reasonable number of attempts to conform the vehicle to its applicable express warranties if, within the first 18 months of ownership of a new vehicle or the first 18,000 miles (29,000 km), whichever occurs first:

1. Two or more repair attempts are made on the same non-conformity likely to cause death or serious bodily injury OR
2. Four or more repair attempts are made on the same nonconformity (a defect or condition that substantially impairs the use, value or safety of the vehicle) OR
3. The vehicle is out of service for repair of nonconformities for a total of more than 30 calendar days (not necessarily all at one time)

In the case of 1 or 2 above, the consumer must also notify the manufacturer of the need for the repair of the nonconformity at the following address:

Ford Motor Company  
16800 Executive Plaza Drive  
Mail Drop 3NE-B  
Dearborn, MI 48126

You are required to submit your warranty dispute to BBB AUTO LINE before asserting in court any rights or remedies conferred by California Civil Code Section 1793.22(b). You are also required to use BBB AUTO LINE before exercising rights or seeking remedies created by the Federal Magnuson-Moss Warranty Act, 15 U.S.C. sec. 2301 et seq. If you choose to seek redress by pursuing rights and remedies not created by California Civil Code Section 1793.22(b) or the Magnuson-Moss Warranty Act, resort to BBB AUTO LINE is not required by those statutes.

## Customer Assistance

### THE BETTER BUSINESS BUREAU (BBB) AUTO LINE PROGRAM (U.S. ONLY)

Your satisfaction is important to Ford Motor Company and to your dealer. If a warranty concern has not been resolved using the three-step procedure outlined earlier in this chapter in the *Getting the services you need* section, you may be eligible to participate in the BBB AUTO LINE program.

The BBB AUTO LINE program consists of two parts – mediation and arbitration. During mediation, a representative of the BBB will contact both you and Ford Motor Company to explore options for settlement of the claim. If an agreement is not reached during mediation or you do not want to participate in mediation, and if your claim is eligible, you may participate in the arbitration process. An arbitration hearing will be scheduled so that you can present your case in an informal setting before an impartial person. The arbitrator will consider the testimony provided and make a decision after the hearing.

Disputes submitted to the BBB AUTO LINE program are usually decided within forty days after you file your claim with the BBB. You are not bound by the decision, and may reject the decision and proceed to court where all findings of the BBB Auto Line dispute, and decision, are admissible in the court action. Should you choose to accept the BBB AUTO LINE decision, Ford is then bound by the decision, and must comply with the decision within 30 days of receipt of your acceptance letter.

BBB AUTO LINE Application: Using the information provided below, please call or write to request a program application. You will be asked for your name and address, general information about your new vehicle, information about your warranty concerns, and any steps you have already taken to try to resolve them. A Customer Claim Form will be mailed that will need to be completed, signed and returned to the BBB along with proof of ownership. Upon receipt, the BBB will review the claim for eligibility under the Program Summary Guidelines.

**You can get more information by calling BBB AUTO LINE at 1-800-955-5100, or writing to:**

**BBB AUTO LINE  
4200 Wilson Boulevard, Suite 800  
Arlington, Virginia 22203-1833**

BBB AUTO LINE applications can also be requested by calling the Ford Motor Company Customer Relationship Center at 1-800-392-3673.

**Note:** Ford Motor Company reserves the right to change eligibility limitations, modify procedures, or to discontinue this process at any time without notice and without obligation.

## Customer Assistance

### **UTILIZING THE MEDIATION/ARBITRATION PROGRAM (CANADA ONLY)**

For vehicles delivered to authorized Canadian dealers. In those cases where you continue to feel that the efforts by Ford of Canada and the authorized dealer to resolve a factory-related vehicle service concern have been unsatisfactory, Ford of Canada participates in an impartial third party mediation/arbitration program administered by the Canadian Motor Vehicle Arbitration Plan (CAMVAP).

The CAMVAP program is a straight forward and relatively speedy alternative to resolve a disagreement when all other efforts to produce a settlement have failed. This procedure is without cost to you and is designed to eliminate the need for lengthy and expensive legal proceedings.

In the CAMVAP program, impartial third-party arbitrators conduct hearings at mutually convenient times and places in an informal environment. These impartial arbitrators review the positions of the parties, make decisions and, when appropriate, render awards to resolve disputes. CAMVAP decisions are fast, fair, and final as the arbitrator's award is binding on both you and Ford of Canada.

CAMVAP services are available in all Canadian territories and provinces. For more information, without charge or obligation, call your CAMVAP Provincial Administrator directly at 1-800-207-0685 or visit [www.camvap.ca](http://www.camvap.ca).

### **GETTING ASSISTANCE OUTSIDE THE U.S. AND CANADA**

Before exporting your vehicle to a foreign country, contact the appropriate foreign embassy or consulate. These officials can inform you of local vehicle registration regulations and where to find unleaded fuel.

If you cannot find unleaded fuel or can only get fuel with an anti-knock index lower than is recommended for your vehicle, contact a regional office or owner relations/customer relationship office.

The use of leaded fuel in your vehicle without proper conversion may damage the effectiveness of your emission control system and may cause engine knocking or serious engine damage. Ford Motor Company/Ford of Canada is not responsible for any damage caused by use of improper fuel. Using leaded fuel may also result in difficulty importing your vehicle back into the U.S.

## Customer Assistance

If your vehicle must be serviced while you are traveling or living in Asia-Pacific Region, Sub-Saharan Africa, U.S. Virgin Islands, Central America, the Caribbean, and Israel, contact the nearest authorized dealer. If the authorized dealer cannot help you, contact:

FORD MOTOR COMPANY  
FORD EXPORT OPERATIONS & GLOBAL INITIATIVES  
1555 Fairlane Drive  
Fairlane Business Park #3  
Allen Park, Michigan 48101  
U.S.A.

Telephone: (313) 594-4857

For customers in Guam, the Commonwealth of the Northern Mariana Islands (CNMI), America Samoa, and the U.S. Virgin Islands, please feel free to call our Toll-Free Number: (800) 841-FORD (3673).

FAX: (313) 390-0804

Email: [expcac@ford.com](mailto:expcac@ford.com)

If your vehicle must be serviced while you are traveling or living in Puerto Rico, contact the nearest authorized dealer. If the authorized dealer cannot help you, contact:

Ford International Business Development Inc.  
Customer Relationship Center  
P.O. Box 11957  
Caparra Heights Station  
San Juan, Puerto Rico 00922-1957  
Telephone: (800) 841-FORD (3673)  
FAX: (313) 390-0804  
Email: [prcac@ford.com](mailto:prcac@ford.com)  
[www.ford.com.pr](http://www.ford.com.pr)

If your vehicle must be serviced while you are traveling or living in the Middle East, contact the nearest authorized dealer. If the authorized dealer cannot help you, contact:

Ford Middle East  
Customer Relationship Center  
P.O. Box 21470  
Dubai, United Arab Emirates  
Telephone: +971 4 3326084  
Toll-Free Number for the Kingdom of Saudi Arabia: 800 8971409  
Local Telephone Number for Kuwait: 24810575  
FAX: +971 4 3327299  
Email: [menacac@ford.com](mailto:menacac@ford.com)  
[www.me.ford.com](http://www.me.ford.com)

284

<https://www.MyCarManual.com>

## Customer Assistance

If you buy your vehicle in North America and then relocate to any of the above locations, register your vehicle identification number (VIN) and new address with Ford Motor Company Export Operations & Global Growth Initiatives by emailing [expcac@ford.com](mailto:expcac@ford.com).

If you are in another foreign country, contact the nearest authorized dealer. If the authorized dealer employees cannot help you, they can direct you to the nearest Ford affiliate office.

**Customers in the U.S. should call 1-800-392-3673.**

### ORDERING ADDITIONAL OWNER'S LITERATURE

To order the publications in this portfolio, contact Helm, Incorporated at:

HELM, INCORPORATED  
47911 Halyard Drive  
Plymouth, Michigan 48170  
Attention: Customer Service

Or to order a free publication catalog, call toll free: 1-800-782-4356

Monday-Friday 8:00 a.m. - 6:00 p.m. EST

Helm, Incorporated can also be reached by their website:  
[www.helminc.com](http://www.helminc.com).

*(Items in this catalog may be purchased by credit card, check or money order.)*

### Obtaining a French Owner's Guide

French Owner's Guides can be obtained from your authorized dealer or by contacting Helm, Incorporated using the contact information listed previously in this section.

## Customer Assistance

### REPORTING SAFETY DEFECTS (U.S. ONLY)

If you believe that your vehicle has a defect which could cause a crash or could cause injury or death, you should immediately inform the National Highway Traffic Safety Administration (NHTSA) in addition to notifying Ford Motor Company.



If NHTSA receives similar complaints, it may open an investigation, and if it finds that a safety defect exists in a group of vehicles, it may order a recall and remedy campaign. However, NHTSA cannot become involved in individual problems between you, your dealer, or Ford Motor Company.

To contact NHTSA, you may call the Vehicle Safety Hotline toll-free at 1-888-327-4236 (TTY: 1-800-424-9153); go to <http://www.safercar.gov>; or write to:

Administrator  
1200 New Jersey Avenue, Southeast  
Washington, D.C. 20590

You can also obtain other information about motor vehicle safety from <http://www.safercar.gov>.

### REPORTING SAFETY DEFECTS (CANADA ONLY)

If you believe that your vehicle has a defect which could cause a crash or could cause injury or death, you should immediately inform Transport Canada, using their toll-free number: 1-800-333-0510, or online at: <https://wwwapps.tc.gc.ca/Saf-Sec-Sur/7/PCDB-BDPP/Index.aspx>.

### WASHING THE EXTERIOR

Wash your vehicle regularly with cool or lukewarm water and a neutral pH shampoo, such as Motorcraft® Detail Wash (ZC-3-A), which is available from your authorized dealer.

- Never use strong household detergents or soap, such as dish washing or laundry liquid. These products can discolor and spot painted surfaces.
- Never wash a vehicle that is “hot to the touch” or during exposure to strong, direct sunlight.
- Always use a clean sponge or car wash mitt with plenty of water for best results.
- Dry the vehicle with a chamois or soft terry cloth towel in order to eliminate water spotting.
- It is especially important to wash the vehicle regularly during the winter months, as dirt and road salt are difficult to remove and cause damage to the vehicle.
- Immediately remove items such as gasoline, diesel fuel, bird droppings and insect deposits because they can cause damage to the vehicle’s paintwork and trim over time. Use Motorcraft® Bug and Tar Remover (ZC-42) which is available from your authorized dealer.
- Remove any exterior accessories, such as antennas, before entering a car wash.
- **Suntan lotions and insect repellents can damage any painted surface; if these substances come in contact with your vehicle, wash off as soon as possible.**

### Exterior chrome

- Wash the vehicle first, using cool or lukewarm water and a neutral pH shampoo, such as Motorcraft® Detail Wash (ZC-3-A).
- Use Motorcraft® Custom Bright Metal Cleaner (ZC-15), available from your authorized dealer. Apply the product as you would a wax to clean bumpers and other chrome parts; allow the cleaner to dry for a few minutes, then wipe off the haze with a clean, dry rag.
- **Never use abrasive materials such as steel wool or plastic pads as they can scratch the chrome surface.**

### WAXING

- Wash the vehicle first.
- Use a quality wax that does not contain abrasives.

## Cleaning

- Do not allow paint sealant to come in contact with any non-body (low-gloss black) colored trim, such as grained door handles, roof racks, bumpers, side moldings, mirror housings or the windshield cowl area. The paint sealant will “gray” or stain the parts over time.

### PAINT CHIPS

Your authorized dealer has touch-up paint to match your vehicle’s color. Take your color code (printed on a sticker in the driver’s door jamb) to your authorized dealer to ensure you get the correct color.

- Remove particles such as bird droppings, tree sap, insect deposits, tar spots, road salt and industrial fallout before repairing paint chips.
- Always read the instructions before using the products.

### ALUMINUM WHEELS AND WHEEL COVERS

Aluminum wheels and wheel covers are coated with a clear coat paint finish. In order to maintain their shine:

- Clean weekly with Motorcraft® Wheel and Tire Cleaner, which is available from your authorized dealer. Heavy dirt and brake dust accumulation may require agitation with a sponge. Rinse thoroughly with a strong stream of water.
- Never apply any cleaning chemical to hot or warm wheel rims or covers.
- Some automatic car washes may cause damage to the finish on your wheel rims or covers. Industrial-strength (heavy-duty) cleaners, or cleaning chemicals, in combination with brush agitation to remove brake dust and dirt, could wear away the clear coat finish over time.
- Do not use hydrofluoric acid-based or high caustic-based wheel cleaners, steel wool, fuels or strong household detergent.
- To remove tar and grease, use Motorcraft® Bug and Tar Remover , available from your authorized dealer.



## Cleaning

### ENGINE

Engines are more efficient when they are clean because grease and dirt buildup keep the engine warmer than normal.

When washing:

- Take care when using a power washer to clean the engine. The high-pressure fluid could penetrate the sealed parts and cause damage.
- Do not spray a hot engine with cold water to avoid cracking the engine block or other engine components.
- Spray Motorcraft® Engine Shampoo and Degreaser (ZC-20) on all parts that require cleaning and pressure rinse clean. In Canada, use Motorcraft® Engine Shampoo (CXC-66-A).
- Never wash or rinse the engine while it is hot or running; water in the running engine may cause internal damage.
- Never wash or rinse any ignition coil, spark plug wire or spark plug well, or the area in and around these locations.
- Cover the darkly shaded areas to prevent water damage when cleaning the engine.



## Cleaning

### PLASTIC (NON-PAINTED) EXTERIOR PARTS

Use only approved products to clean plastic parts. These products are available from your authorized dealer.

- For routine cleaning, use Motorcraft® Detail Wash (ZC-3-A).
- If tar or grease spots are present, use Motorcraft® Bug and Tar Remover (ZC-42).

### WINDOWS AND WIPER BLADES

The windshield, rear and side windows and the wiper blades should be cleaned regularly. If the wipers do not wipe properly, substances on the vehicle's glass or the wiper blades may be the cause. These may include hot wax treatments used by commercial car washes, water repellent coatings, tree sap, or other organic contamination; these contaminants may cause squeaking or chatter noise from the blades, and streaking and smearing of the windshield. To clean these items, follow these tips:

- The windshield, rear windows and side windows may be cleaned with a non-abrasive cleaner such as Motorcraft® Ultra-Clear Spray Glass Cleaner (ZC-23), available from your authorized dealer.
- The wiper blades can be cleaned with isopropyl (rubbing) alcohol or Motorcraft® Premium Windshield Washer Concentrate (ZC-32-A) in the U.S., or Premium Quality Windshield Washer Fluid [CXC-37-(A, B, D, or F)] in Canada, available from your authorized dealer. This washer fluid contains special solution in addition to alcohol which helps to remove the hot wax deposited on the wiper blade and windshield from automated car wash facilities. Be sure to replace wiper blades when they appear worn or do not function properly.
- Do not use abrasives, as they may cause scratches.
- Do not use fuel, kerosene, or paint thinner to clean any parts.

If you cannot remove those streaks after cleaning with the glass cleaner or if the wipers chatter and move in a jerky motion, clean the outer surface of the windshield and the wiper blades using a sponge or soft cloth with a neutral detergent or mild-abrasive cleaning solution. After cleaning, rinse the windshield and wiper blades with clean water. The windshield is clean if beads do not form when you rinse the windshield with water.

**Do not use sharp objects, such as a razor blade, to clean the inside of the rear window or to remove decals, as it may cause damage to the rear window defroster's heated grid lines.**

## Cleaning

### INSTRUMENT PANEL/INTERIOR TRIM AND CLUSTER LENS

Clean the instrument panel, interior trim areas and cluster lens with a clean, damp, white cotton cloth, then use a clean and dry white cotton cloth to dry these areas.

- Avoid cleaners or polishes that increase the gloss of the upper portion of the instrument panel. The dull finish in this area helps protect the driver from undesirable windshield reflection.
- Be certain to wash or wipe your hands clean if you have been in contact with certain products such as insect repellent and suntan lotion in order to avoid possible damage to the interior painted surfaces.
- Do not use household or glass cleaners as these may damage the finish of the instrument panel, interior trim and cluster lens.
- Do not allow air fresheners and hand sanitizers to spill on interior surfaces. If a spill occurs, **wipe off immediately**. Damage may not be covered by your warranty.



**WARNING:** Do not use chemical solvents or strong detergents when cleaning the steering wheel or instrument panel to avoid contamination of the airbag system.

If a staining liquid like coffee/juice has been spilled on the instrument panel or on interior trim surfaces, clean as follows:

1. Wipe up spilled liquid using a clean, white, cotton cloth.
2. Wipe the surface with a damp, clean, white cotton cloth. For more thorough cleaning, use a mild soap and water solution. If the spot cannot be completely cleaned by this method, the area may be cleaned using a commercially available cleaning product designed for automotive interiors.
3. If necessary, apply more soap and water solution or cleaning product to a clean, white, cotton cloth and press the cloth onto the soiled area—allow this to set at room temperature for 30 minutes.
4. Remove the soaked cloth, and if it is not soiled badly, use this cloth to clean the area by using a rubbing motion for 60 seconds.
5. Following this, wipe area dry with a clean, white, cotton cloth.

## Cleaning

### INTERIOR

For fabric, carpets, cloth seats, safety belts and seats equipped with side airbags:

- Remove dust and loose dirt with a vacuum cleaner.
- Remove light stains and soil with Motorcraft® Professional Strength Carpet & Upholstery Cleaner (ZC-54).
- If grease or tar is present on the material, spot-clean the area first with Motorcraft® Spot and Stain Remover (ZC-14). In Canada, use Motorcraft® Multi-Purpose Cleaner (CXC-101).
- If a ring forms on the fabric after spot cleaning, clean the entire area immediately (but do not oversaturate) or the ring will set.
- Do not use household cleaning products or glass cleaners, which can stain and discolor the fabric and affect the flame retardant abilities of the seat materials.



**WARNING:** Do not use cleaning solvents, bleach or dye on the vehicle's safety belts, as these actions may weaken the belt webbing.



**WARNING:** On vehicles equipped with seat-mounted airbags, do not use chemical solvents or strong detergents. Such products could contaminate the side-airbag system and affect performance of the side airbag in a collision.

### LEATHER SEATS (IF EQUIPPED)

- Remove dust and loose dirt with a vacuum cleaner.
- Clean spills and stains as quickly as possible.
- For routine cleaning, wipe the surface with a soft, damp cloth. For more thorough cleaning, wipe the surface with a mild soap and water solution. In Canada, use Motorcraft® Vinyl Cleaner (CXC-93). Dry the area with a soft cloth.
- If the leather cannot be completely cleaned using a mild soap and water solution, the leather may be cleaned using a commercially available leather cleaning product designed for automotive interiors.
- To check for compatibility, first test any cleaner or stain remover on an inconspicuous part of the leather.
- Do not use household cleaning products, alcohol solutions, solvents or cleaners intended for rubber, vinyl and plastics, or oil/petroleum-based leather conditioners. These products may cause premature wearing or damage to the leather.

### UNDERBODY

Flush the complete underside of your vehicle frequently. Keep body and door drain holes free from packed dirt.

### FORD AND LINCOLN CAR CARE PRODUCTS

Your Ford or Lincoln authorized dealer has many quality products available to clean your vehicle and protect its finishes. These quality products have been specifically engineered to fulfill your automotive needs; they are custom designed to complement the style and appearance of your vehicle. Each product is made from high quality materials that meet or exceed rigid specifications. For best results, use the following products or products of equivalent quality:

- Motorcraft® Bug and Tar Remover (ZC-42)
- Motorcraft® Custom Bright Metal Cleaner (ZC-15)
- Motorcraft® Detail Wash (ZC-3-A)
- Motorcraft® Dusting Cloth (ZC-24)
- Motorcraft® Engine Shampoo and Degreaser (U.S. only) (ZC-20)
- Motorcraft® Engine Shampoo (Canada only) (CXC-66-A)
- Motorcraft® Multi-Purpose Cleaner (Canada only) (CXC-101)
- Motorcraft® Premium Glass Cleaner (Canada only) (CXC-100)
- Motorcraft® Premium Quality Windshield Washer Fluid (Canada only) [CXC-37-(A, B, D or F)]
- Motorcraft® Premium Windshield Washer Concentrate (U.S. only) (ZC-32-A)
- Motorcraft® Professional Strength Carpet & Upholstery Cleaner (ZC-54)
- Motorcraft® Spot and Stain Remover (U.S. only) (ZC-14)
- Motorcraft® Ultra-Clear Spray Glass Cleaner (ZC-23)
- Motorcraft® Vinyl Cleaner (Canada only) (CXC-93)
- Motorcraft® Wheel and Tire Cleaner (ZC-37-A)

## Maintenance and Specifications

### SERVICE RECOMMENDATIONS

To help you service your vehicle, we provide *scheduled maintenance information* which makes tracking routine service easy.

If your vehicle requires professional service, your authorized dealer can provide the necessary parts and service. Check your *Warranty Guide* to find out which parts and services are covered.

Use only recommended fuels, lubricants, fluids and service parts conforming to specifications. Motorcraft® parts are designed and built to provide the best performance in your vehicle.

### PRECAUTIONS WHEN SERVICING YOUR VEHICLE

Be especially careful when inspecting or servicing your vehicle.

- Do not work on a hot engine.
- When the engine is running, make sure that loose clothing, jewelry or long hair does not get caught in moving parts.
- Do not work on a vehicle with the engine running in an enclosed space, unless you are sure you have enough ventilation.
- Keep all open flames and other burning (cigarettes) material away from the battery and all fuel related parts.

If you disconnect the battery, the engine must “relearn” its idle condition before your vehicle will drive properly, as explained in *Battery* in this section.

#### Working with the engine off

1. For vehicles equipped with an automatic transmission, set the parking brake and shift to P (Park). For vehicles equipped with a manual transmission, set the parking brake, press and hold the clutch pedal, place the gearshift in 1 (First), and release the clutch pedal.
2. Turn off the engine and remove the key.
3. Block the wheels.

#### Working with the engine on

1. For vehicles equipped with an automatic transmission, set the parking brake and shift to P (Park). For vehicles equipped with a manual transmission, set the parking brake, press and hold the clutch pedal, place the gearshift in N (Neutral), and release the clutch pedal.
2. Block the wheels.

## Maintenance and Specifications



**WARNING:** To reduce the risk of vehicle damage and/or personal burn injuries, do not start your engine with the air cleaner removed and do not remove it while the engine is running.

### OPENING THE HOOD

1. Inside the vehicle, pull the hood release handle located under the instrument panel.

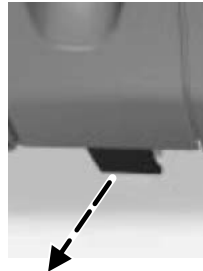

2. Raise the hood slightly. Then push the hood latch release lever, located under the front center of the hood, to the left.

3. Lift the hood and support it with the prop rod.

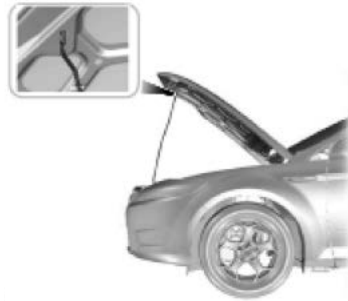

Lower the hood and allow it to drop for the last 8-11 inches (20-30 cm).

## Maintenance and Specifications

### IDENTIFYING COMPONENTS IN THE ENGINE COMPARTMENT

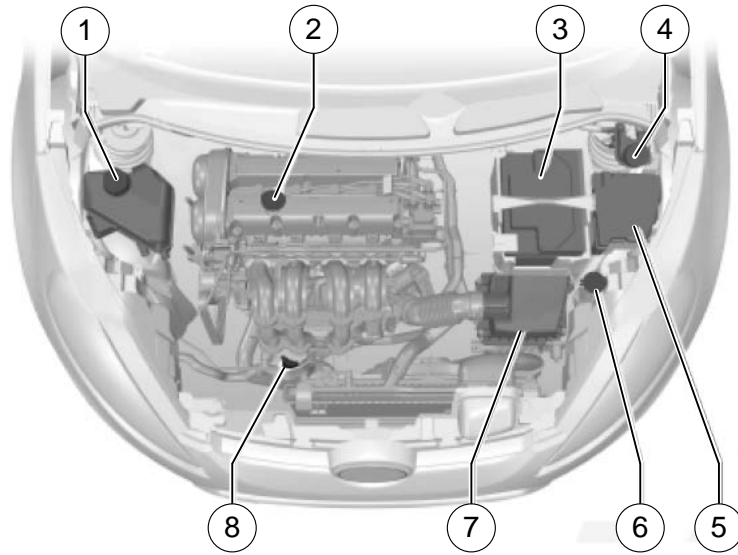

1. Engine coolant reservoir
2. Engine oil filler cap
3. Battery
4. Brake/Clutch fluid reservoir
5. Power distribution box
6. Windshield washer fluid reservoir
7. Air filter assembly
8. Engine oil dipstick



## Maintenance and Specifications

### WINDSHIELD WASHER FLUID

Add fluid to fill the reservoir if the level is low. In very cold weather, do not fill the reservoir completely.

Only use a washer fluid that meets Ford specifications. Do not use any special washer fluid such as windshield water repellent type fluid or bug wash. They may cause squeaking, chatter noise, streaking and smearing. Refer to *Maintenance product specifications and capacities* in this chapter.

State or local regulations on volatile organic compounds may restrict the use of methanol, a common windshield washer antifreeze additive. Washer fluids containing non-methanol antifreeze agents should be used only if they provide cold weather protection without damaging the vehicle's paint finish, wiper blades or washer system.



**WARNING:** If you operate your vehicle in temperatures below 40°F (5°C), use washer fluid with antifreeze protection. Failure to use washer fluid with antifreeze protection in cold weather could result in impaired windshield vision and increase the risk of injury or accident.

### CHANGING THE WIPER BLADES

Change your wiper blades at least once every year. Inspect them by running your finger along each blade to feel for irregularities.

Poor wiper quality can be improved by cleaning the wiper blades and windshield. Refer to *Windows and wiper blades* in the *Cleaning* chapter.

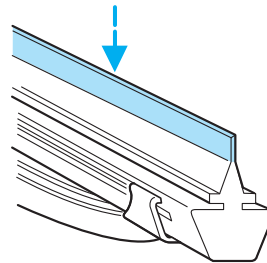

**WARNING:** Worn wiper blades can reduce visibility in rainy weather and cause accidents.

## Maintenance and Specifications

To replace the wiper blades:

1. Pull the wiper arm away from the windshield.
2. Press the locking button (1).
3. Remove the wiper blade (2).

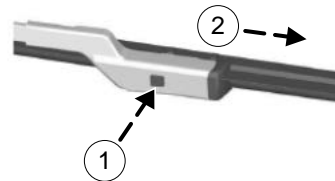

**Note:** Make sure the wiper blade locks into place.

### ENGINE OIL

#### Checking the engine oil

Refer to the *scheduled maintenance information* for the appropriate intervals for checking the engine oil.

1. Make sure the vehicle is at normal operating temperature and parked on level ground.
2. Turn the engine off and wait 15 minutes for the oil to drain into the oil pan.
3. Set the parking brake and ensure the gearshift is securely latched in 1st gear.
4. Open the hood, then locate and carefully remove the engine oil level dipstick.
5. Wipe the dipstick clean. Insert the dipstick fully, then remove it again.
  - If the oil level is **between the MIN and MAX marks**, the oil level is acceptable. **DO NOT ADD OIL.**
  - If the oil level is below the MIN mark, add enough engine oil to raise the level within the MIN and MAX range. Refer to *Adding engine oil* in this chapter.
  - **Oil levels above MAX mark may cause engine damage.** If the engine is overfilled, some oil must be removed from the engine by an authorized dealer.
6. Put the dipstick back in and ensure it is fully seated.

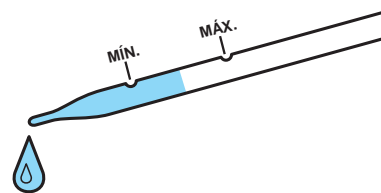

## Maintenance and Specifications

### Adding engine oil

1. Check the engine oil. For instructions, refer to *Checking the engine oil* in this chapter.
2. If the engine oil level is not within the normal range, add only certified engine oil of the recommended viscosity. Remove the engine oil filler cap and use a funnel to pour the engine oil into the opening.
3. Recheck the engine oil level. Make sure the oil level is not above the MAX mark on the engine oil level dipstick.
4. Install the dipstick and ensure it is fully seated.
5. Fully install the engine oil filler cap by turning the filler cap clockwise tightly until it is snug.

**To avoid possible oil loss, DO NOT operate the vehicle with the engine oil level dipstick and/or the engine oil filler cap removed.**

### Engine oil and filter recommendations

Look for this certification trademark.

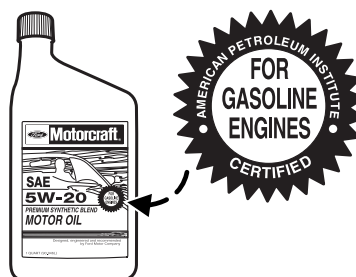

### Use SAE 5W-20 engine oil

Only use oils certified for gasoline engines by the American Petroleum Institute (API). An oil with this trademark symbol conforms to the current engine and emission system protection standards and fuel economy requirements of the International Lubricant Standardization and Approval Committee (ILSAC), comprised of U.S. and Japanese automobile manufacturers.

To protect your engine and engine's warranty, use Motorcraft® SAE 5W-20 or an equivalent SAE 5W-20 oil meeting Ford specification WSS-M2C945-A. **SAE 5W-20 oil provides optimum fuel economy and durability performance meeting all requirements for your vehicle's engine.** Refer to *Maintenance product specifications and capacities* later in this chapter for more information.

## Maintenance and Specifications

Do not use supplemental engine oil additives, cleaners or other engine treatments. They are unnecessary and could lead to engine damage that is not covered by Ford warranty.

Change your engine oil and filter according to the appropriate schedule listed in the *scheduled maintenance information*.

Ford production and Motorcraft® replacement oil filters are designed for added engine protection and long life. If a replacement oil filter is used that does not meet Ford material and design specifications, start-up engine noises or knock may be experienced.

It is recommended you use the appropriate Motorcraft® oil filter or another with equivalent performance for your engine application.

### BATTERY

Your vehicle is equipped with a Motorcraft® maintenance-free battery which normally does not require additional water during its life of service.

**Note:** If your battery has a cover/shield, make sure it is reinstalled after the battery has been cleaned or replaced.

For longer, trouble-free operation, keep the top of the battery clean and dry. Also, make certain the battery cables are always tightly fastened to the battery terminals.

If you see any corrosion on the battery or terminals, remove the cables from the terminals and clean with a wire brush. You can neutralize the acid with a solution of baking soda and water.

It is recommended that the negative battery cable terminal be disconnected from the battery if you plan to store your vehicle for an extended period of time. This will minimize the discharge of your battery during storage.

**Note:** Electrical or electronic accessories or components added to the vehicle by the dealer or the owner may adversely affect battery performance and durability.

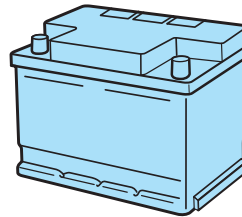

## Maintenance and Specifications

 **WARNING:** Batteries normally produce explosive gases which can cause personal injury. Therefore, do not allow flames, sparks or lighted substances to come near the battery. When working near the battery, always shield your face and protect your eyes. Always provide proper ventilation.

 **WARNING:** When lifting a plastic-cased battery, excessive pressure on the end walls could cause acid to flow through the vent caps, resulting in personal injury and/or damage to the vehicle or battery. Lift the battery with a battery carrier or with your hands on opposite corners.

 **WARNING:** Keep batteries out of reach of children. Batteries contain sulfuric acid. Avoid contact with skin, eyes or clothing. Shield your eyes when working near the battery to protect against possible splashing of acid solution. In case of acid contact with skin or eyes, flush immediately with water for a minimum of 15 minutes and get prompt medical attention. If acid is swallowed, call a physician immediately.

 **WARNING:** Battery posts, terminals and related accessories contain lead and lead compounds. **Note:** Wash hands after handling.

Because your vehicle's engine is electronically controlled by a computer, some control conditions are maintained by power from the battery. When the battery is disconnected or a new battery is installed, the engine must relearn its idle and fuel trim strategy for optimum driveability and performance. To begin this process:

1. With the vehicle at a complete stop, set the parking brake.
  2. Put the gearshift in P (Park) (automatic transmission) or the neutral position (manual transmission), turn off all accessories and start the engine.
  3. Run the engine until it reaches normal operating temperature.
  4. Allow the engine to idle for at least one minute.
  5. Turn the A/C on and allow the engine to idle for at least one minute.
  6. Drive the vehicle to complete the relearning process.
- The vehicle may need to be driven 10 miles (16 km) or more to relearn the idle and fuel trim strategy.

## Maintenance and Specifications

- **If you do not allow the engine to relearn its idle trim, the idle quality of your vehicle may be adversely affected until the idle trim is eventually relearned.**

When the battery is disconnected or a new battery installed, the automatic transmission must relearn its adaptive strategy. As a result of this, the transmission may shift firmly when first driven. This operation is considered normal and will fully update transmission operation to its optimum shift feel.

If the battery has been disconnected or a new battery has been installed, the clock and the preset radio stations must be reset once the battery is reconnected.

- Always dispose of automotive batteries in a responsible manner. Follow your local authorized standards for disposal. Call your local authorized recycling center to find out more about recycling automotive batteries.

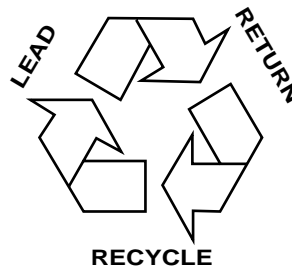

### ENGINE COOLANT

#### Checking engine coolant

The concentration and level of engine coolant should be checked at the intervals listed in *scheduled maintenance information*. The coolant concentration should be maintained at 50/50 coolant and distilled water. For best results, coolant concentration should be tested with a refractometer such as Rotunda tool 300-ROB75240E available from your dealer. Ford does not recommend the use of hydrometers or coolant test strips for measuring coolant concentration. The level of coolant should be maintained at the FULL COLD level or within the COLD FILL RANGE in the coolant reservoir. If the level falls below, add coolant per the instructions in the *Adding engine coolant* section.

Your vehicle was factory-filled with a 50/50 engine coolant and water concentration. If the concentration of coolant falls below 40% or above 60%, the engine parts could become damaged or not work properly. **A 50/50 mixture of coolant and water provides the following:**

- **Improved freeze protection.**

## Maintenance and Specifications

- **Improved boiling protection.**
- **Protection against rust and other forms of corrosion.**
- **Proper function of calibrated gauges.**

When the engine is cold, check the level of the engine coolant in the reservoir.

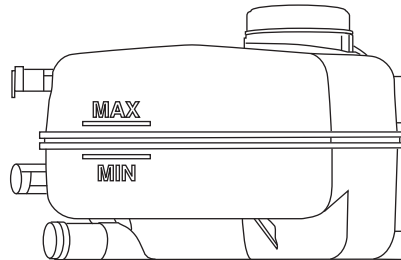

- The engine coolant should be at the FULL COLD level, or within the COLD FILL or MIN / MAX range as listed on the engine coolant reservoir (depending upon application).
- Refer to *scheduled maintenance information* for service interval schedules.

If the engine coolant has not been checked at the recommended interval, the engine coolant reservoir may become low or empty. If the reservoir is low or empty, add engine coolant to the reservoir. Refer to *Adding engine coolant* in this chapter.

**Note:** Automotive fluids are not interchangeable; do not use engine coolant/antifreeze or windshield washer fluid outside of its specified function and vehicle location.

### Adding engine coolant

When adding coolant, make sure it is a 50/50 mixture of engine coolant and distilled water. Add the mixture to the coolant reservoir, **when the engine is cool**, until the appropriate fill level is obtained. If coolant is filled to the COLD FILL RANGE or FULL COLD level when the engine is not cool, the system will remain underfilled.



**WARNING:** Do not add engine coolant when the engine is hot. Steam and scalding liquids released from a hot cooling system can burn you badly. Also, you can be burned if you spill coolant on hot engine parts.

## Maintenance and Specifications



**WARNING:** Do not put engine coolant in the windshield washer fluid container. If sprayed on the windshield, engine coolant could make it difficult to see through the windshield.

- **DO NOT MIX** different colors or types of coolant in your vehicle. Make sure the correct coolant is used. Mixing of engine coolants may harm your engine's cooling system. The use of an improper coolant may harm engine and cooling system components and may void the warranty. Refer to *Maintenance product specifications and capacities* in this chapter.

**Note:** Do not use stop leak pellets or cooling system sealants/additives as they can cause damage to the engine cooling and/or heating systems. This damage would not be covered under your vehicle's warranty.

- A large amount of water without engine coolant may be added, in case of emergency, to reach a vehicle service location. In this instance, the cooling system must be drained, chemically cleaned with Motorcraft® Premium Cooling System Flush, and refilled with a 50/50 mixture of engine coolant and distilled water as soon as possible. Water alone (without engine coolant) can cause engine damage from corrosion, overheating or freezing.
- **Do not use alcohol, methanol, brine or any engine coolants mixed with alcohol or methanol antifreeze (coolant).** Alcohol and other liquids can cause engine damage from overheating or freezing.
- **Do not add extra inhibitors or additives to the coolant.** These can be harmful and compromise the corrosion protection of the engine coolant.

For vehicles with overflow coolant systems with a non-pressurized cap on the coolant recovery system, add coolant to the coolant recovery reservoir when the engine is cool. Add the proper mixture of coolant and distilled water to the FULL COLD level. For all other vehicles which have a coolant degas system with a pressurized cap, or if it is necessary to remove the coolant pressure relief cap on the radiator of a vehicle with an overflow system, follow these steps to add engine coolant.



**WARNING:** To reduce the risk of personal injury, make sure the engine is cool before unscrewing the coolant pressure relief cap. The cooling system is under pressure; steam and hot liquid can come out forcefully when the cap is loosened slightly.



## Maintenance and Specifications

Add the proper mixture of coolant and water to the cooling system by following these steps:

1. Before you begin, turn the engine off and let it cool.
2. When the engine is cool, wrap a thick cloth around the coolant pressure relief cap on the coolant reservoir (a translucent plastic bottle). Slowly turn cap counterclockwise (left) until pressure begins to release.
3. Step back while the pressure releases.
4. When you are sure that all the pressure has been released, use the cloth to turn it counterclockwise and remove the cap.
5. Fill the coolant reservoir slowly with the proper coolant mixture, to within the FULL COLD level, or within the COLD FILL or MIN / MAX range as listed on the engine coolant reservoir (depending upon application). If you removed the radiator cap in an overflow system, fill the radiator until the coolant is visible and radiator is almost full.
6. Replace the cap. Turn until tightly installed. Cap must be tightly installed to prevent coolant loss.

After any coolant has been added, check the coolant concentration (refer to *Checking engine coolant*). If the concentration is not 50/50, drain some coolant and adjust the concentration. It may take several drains and additions to obtain a 50/50 coolant concentration.

Whenever coolant has been added, the coolant level in the coolant reservoir should be checked the next few times you drive the vehicle. If necessary, add enough 50/50 concentration of engine coolant and distilled water to bring the liquid level to the proper level.

If you have to add more than 1.0 quart (1.0 liter) of engine coolant per month, have your authorized dealer check the engine cooling system. Your cooling system may have a leak. Operating an engine with a low level of coolant can result in engine overheating and possible engine damage.

### Recycled engine coolant

Ford Motor Company does NOT recommend the use of recycled engine coolant since a Ford-approved recycling process is not yet available.



Used engine coolant should be disposed of in an appropriate manner. Follow your community's regulations and standards for recycling and disposing of automotive fluids.

## Maintenance and Specifications

### Coolant refill capacity

To find out how much fluid your vehicle's cooling system can hold, refer to *Maintenance product specifications and capacities* in this chapter.

Fill your engine coolant reservoir as outlined previously in the *Adding engine coolant* section.

### Severe climates

If you drive in extremely cold climates:

- **It may be necessary to increase the coolant concentration above 50%.**
- **NEVER increase the coolant concentration above 60%.**
- **A coolant concentration of 60% will provide improved freeze point protection. Increased engine coolant concentrations above 60% will decrease the overheat protection characteristics of the engine coolant and may cause engine damage.**
- **If available, refer to the chart on the coolant container to ensure the coolant concentration in your vehicle will provide adequate freeze protection at the temperatures in which you drive in the winter months.**

If you drive in extremely hot climates:



- **It is still necessary to maintain the coolant concentration above 40%.**
- **NEVER decrease the coolant concentration below 40%.**
- **Decreased engine coolant concentrations below 40% will decrease the corrosion/freeze protection characteristics of the engine coolant and may cause engine damage.**
- **If available, refer to the chart on the coolant container to ensure the coolant concentration in your vehicle will provide adequate protection at the temperatures in which you drive.**

Vehicles driven year-round in non-extreme climates should use a 50/50 mixture of engine coolant and distilled water for optimum cooling system and engine protection.

## Maintenance and Specifications

### Reduced engine power due to high temperature

If the engine begins to overheat:

- The engine malfunction  indicator will illuminate.
- The service engine soon  indicator will illuminate.

If either lamp illuminates when the engine is running, this indicates a fault. The engine will continue to run, but it may have limited power. If it begins to flash when you are driving, reduce the speed of your vehicle immediately. If it continues to flash, avoid heavy acceleration or deceleration. Have the system checked by a properly trained technician immediately.

If both lamps illuminate together, stop your vehicle as soon as it is safe to do so (continued use may cause reduced power and cause the engine to stop). Have the system checked by a properly trained technician immediately. The vehicle must be checked before continuing to drive the vehicle.

### FUEL FILTER

Your vehicle is equipped with a lifetime fuel filter that is integrated with the fuel tank. Regular maintenance or replacement is not needed.

### WHAT YOU SHOULD KNOW ABOUT AUTOMOTIVE FUELS

#### Important safety precautions



**WARNING:** Do not overfill the fuel tank. The pressure in an overfilled tank may cause leakage and lead to fuel spray and fire.



**WARNING:** The fuel system may be under pressure. If you hear a hissing sound near the fuel filler door, do not refuel until the sound stops. Otherwise, fuel may spray out, which could cause serious personal injury.



**WARNING:** Automotive fuels can cause serious injury or death if misused or mishandled.



**WARNING:** Gasoline may contain benzene, which is a cancer-causing agent.

## Maintenance and Specifications

Observe the following guidelines when handling automotive fuel:

- Extinguish all smoking materials and any open flames before refueling your vehicle.
- Always turn off the vehicle before refueling.
- Automotive fuels can be harmful or fatal if swallowed. Fuel such as gasoline is highly toxic and if swallowed can cause death or permanent injury. If fuel is swallowed, call a physician immediately, even if no symptoms are immediately apparent. The toxic effects of fuel may not be visible for hours.
- Avoid inhaling fuel vapors. Inhaling too much fuel vapor of any kind can lead to eye and respiratory tract irritation. In severe cases, excessive or prolonged breathing of fuel vapor can cause serious illness and permanent injury.
- Avoid getting fuel liquid in your eyes. If fuel is splashed in the eyes, remove contact lenses (if worn), flush with water for 15 minutes and seek medical attention. Failure to seek proper medical attention could lead to permanent injury.
- Fuels can also be harmful if absorbed through the skin. If fuel is splashed on the skin and/or clothing, promptly remove contaminated clothing and wash skin thoroughly with soap and water. Repeated or prolonged skin contact with fuel liquid or vapor causes skin irritation.
- Be particularly careful if you are taking “Antabuse” or other forms of disulfiram for the treatment of alcoholism. Breathing gasoline vapors, or skin contact could cause an adverse reaction. In sensitive individuals, serious personal injury or sickness may result. If fuel is splashed on the skin, promptly wash skin thoroughly with soap and water. Consult a physician immediately if you experience an adverse reaction.



**WARNING:** When refueling always shut the engine off and never allow sparks or open flames near the filler neck. Never smoke while refueling. Fuel vapor is extremely hazardous under certain conditions. Care should be taken to avoid inhaling excess fumes.



**WARNING:** The flow of fuel through a fuel pump nozzle can produce static electricity, which can cause a fire if fuel is pumped into an ungrounded fuel container.

## Maintenance and Specifications

### Refueling



**WARNING:** Fuel vapor burns violently and a fuel fire can cause severe injuries. To help avoid injuries to you and others:

- Read and follow all the instructions on the pump island;
- Turn off your engine when you are refueling;
- Do not smoke if you are near fuel or refueling your vehicle;
- Keep sparks, flames and smoking materials away from fuel;
- Stay outside your vehicle and do not leave the fuel pump unattended when refueling your vehicle — this is against the law in some places;
- Keep children away from the fuel pump; never let children pump fuel.
- Do not use personal electronic devices while refueling. It can ignite fuel vapors.

Use the following guidelines to avoid electrostatic charge build-up when filling an ungrounded fuel container:

- Place approved fuel container on the ground.
- DO NOT fill a fuel container while it is in the vehicle (including the cargo area).
- Keep the fuel pump nozzle in contact with the fuel container while filling.
- DO NOT use a device that would hold the fuel pump handle in the fill position.

### Easy Fuel® “no cap” fuel system

Your fuel tank is equipped with an Easy Fuel® “no cap” fuel filler system. This allows you to simply open the fuel filler door and insert the fuel filler nozzle into the fuel system. The Easy Fuel® system is self-sealing and protected against dust, dirt, water and snow/ice.

When fueling your vehicle:

1. Turn the engine off.
2. Open the fuel filler door.
3. Slowly insert the fuel filler nozzle fully into the fuel system, and leave the nozzle fully inserted until you are done pumping. Pump fuel as normal.
4. After you are done pumping fuel, slowly remove the fuel filler nozzle—allow about five seconds after pumping fuel before removing the fuel filler nozzle. This allows residual fuel to drain back into the fuel tank and not spill onto the vehicle.

## Maintenance and Specifications

**Note:** A fuel spillage concern may occur if overfilling the fuel tank. Do not overfill the tank to the point that the fuel is able to bypass the fuel filler nozzle.

If the check fuel fill inlet lamp comes on, the fuel fill inlet may not have properly closed. The inlet may have stuck open or debris may be preventing the inlet from fully closing. At the next opportunity, safely pull off the road, turn off the engine, open the fuel filler door and remove any visible debris from the fuel fill opening. Insert either the fuel fill nozzle or the fuel fill funnel (see *Refilling with a portable fuel container* for funnel location) provided with the vehicle several times to dislodge any debris and/or allow the inlet to close properly. If this action corrects the problem, the check fuel fill inlet lamp may not reset immediately. It may take several driving cycles for the check fuel fill inlet lamp to turn off. A driving cycle consists of an engine start-up (after four or more hours with the engine off) followed by city/highway driving. Continuing to drive with the check fuel fill inlet lamp on may cause the service engine soon lamp to turn on as well.



**WARNING:** The fuel system may be under pressure. If you hear a hissing sound near the fuel filler door (Easy Fuel® “no cap” fuel system), do not refuel until the sound stops. Otherwise, fuel may spray out, which could cause serious personal injury.

### Choosing the right fuel

Use only UNLEADED fuel or UNLEADED fuel blended with a maximum of 10% ethanol. Do not use fuel ethanol (E85), diesel, methanol, leaded fuel or any other fuel. The use of leaded fuel is prohibited by law and could damage your vehicle.

Your vehicle was not designed to use fuel or fuel additives with metallic compounds, including manganese-based additives.

**Note:** Use of any fuel other than those recommended may cause powertrain damage, a loss of vehicle performance, and repairs may not be covered under warranty.

### Octane Recommendations

“Regular” unleaded gasoline with a pump (R+M)/2 octane rating of 87 is recommended. Some stations offer fuels posted as “Regular” with an octane rating below 87, particularly in high altitude areas. Fuels with octane levels below 87 are not recommended.

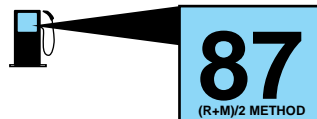

## Maintenance and Specifications

Do not be concerned if your engine sometimes knocks lightly. However, if it knocks heavily under most driving conditions while you are using fuel with the recommended octane rating, see your authorized dealer to prevent any engine damage.

### Fuel quality

If you are experiencing starting, rough idle or hesitation driveability problems during a cold start, try a different brand of “Regular” unleaded gasoline.

Do not add aftermarket fuel additive products to your fuel tank. It should not be necessary to add any aftermarket products to your fuel tank if you continue to use high quality fuel of the recommended octane rating. These products have not been approved for your engine and could cause damage to the fuel system. Repairs to correct the effects of using an aftermarket product in your fuel may not be covered by your warranty.

Many of the world’s automakers approved the World-Wide Fuel Charter that recommends gasoline specifications to provide improved performance and emission control system protection for your vehicle. Gasolines that meet the World-Wide Fuel Charter should be used when available. Ask your fuel supplier about gasolines that meet the World-Wide Fuel Charter.

### Cleaner air

Ford endorses the use of reformulated “cleaner-burning” gasolines to improve air quality, per the recommendations in the *Choosing the right fuel* section.

### Running out of fuel

Avoid running out of fuel because this situation may have an adverse effect on powertrain components.

If you have run out of fuel:

- You may need to cycle the ignition from off to on several times after refueling to allow the fuel system to pump the fuel from the tank to the engine. On restarting, cranking time will take a few seconds longer than normal.
- Normally, adding 1 gallon (3.8L) of fuel is enough to restart the engine. If the vehicle is out of fuel and on a steep grade, more than 1 gallon (3.8L) may be required.
- The service engine soon  indicator may come on. For more information on the service engine soon indicator, refer to *Warning lights and chimes* in the *Instrument Cluster* chapter.

## Maintenance and Specifications

### Refilling with a portable fuel container

With the Easy Fuel® “no cap” fuel system, use the following directions when filling from a portable fuel container:

 **WARNING:** Do not insert the nozzle of portable fuel containers or aftermarket funnels into the Easy Fuel® system. This could damage the fuel system and its seal, and may cause fuel to run onto the ground instead of filling the tank, which could result in serious personal injury.

 **WARNING:** Do not try to pry open or push open the Easy Fuel® system with foreign objects. This could damage the fuel system and its seal and cause injury to you or others.

When filling the vehicle’s fuel tank from a portable fuel container, use the included funnel.

1. To locate the white plastic funnel, lift the carpeted floor panel covering the spare tire in the rear of the vehicle. The funnel is visible in the foam pod on the spare tire.

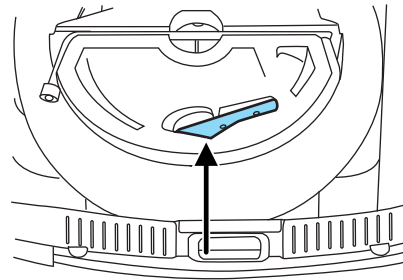

2. Slowly insert the funnel into the Easy Fuel® system.  
3. Fill the vehicle with fuel from the portable fuel container.  
4. When done, clean the funnel or properly dispose of it. Extra funnels can be purchased from your authorized dealer if you choose to dispose of the funnel. **Do not** use aftermarket funnels; they will not work with the Easy Fuel® system and can damage it. The included funnel has been specially designed to work safely with your vehicle.



## Maintenance and Specifications

### ESSENTIALS OF GOOD FUEL ECONOMY

#### Measuring techniques

Your best source of information about actual fuel economy is you, the driver. You must gather information as accurately and consistently as possible. Fuel expense, frequency of fill-ups or fuel gauge readings are NOT accurate as a measure of fuel economy. We do not recommend taking fuel economy measurements during the first 1,000 miles (1,600 km) of driving (engine break-in period). You will get a more accurate measurement after 2,000 miles–3,000 miles (3,000 km–5,000 km).

#### Filling the tank

The advertised fuel capacity of the fuel tank on your vehicle is equal to the rated refill capacity of the fuel tank as listed in the *Maintenance product specifications and capacities* section of this chapter.

The advertised capacity is the amount of the indicated capacity and the empty reserve combined. Indicated capacity is the difference in the amount of fuel in a full tank and a tank when the fuel gauge indicates empty. Empty reserve is the small amount of fuel remaining in the fuel tank after the fuel gauge indicates empty.

**The amount of usable fuel in the empty reserve varies and should not be relied upon to increase driving range. When refueling your vehicle after the fuel gauge indicates empty, you might not be able to refuel the full amount of the advertised capacity of the fuel tank due to the empty reserve still present in the tank.**

For consistent results when filling the fuel tank:

- Turn the engine/ignition switch off prior to refueling, an error in the reading will result if the engine is left running.
- Use the same filling rate setting (low — medium — high) each time the tank is filled.
- Allow no more than two automatic click-offs when filling.
- Always use fuel with the recommended octane rating.
- Use a known quality gasoline, preferably a national brand.
- Have the vehicle loading and distribution the same every time.

Your results will be most accurate if your filling method is consistent.

## Maintenance and Specifications

### Calculating fuel economy

1. Fill the fuel tank completely and record the initial odometer reading (in miles or kilometers).
2. Each time you fill the tank, record the amount of fuel added (in gallons or liters).
3. After at least three to five tank fill-ups, fill the fuel tank and record the current odometer reading.
4. Subtract your initial odometer reading from the current odometer reading.
5. Follow one of the simple calculations in order to determine fuel economy:

Calculation 1: **Divide total miles traveled by total gallons used.**

Calculation 2: **Multiply liters used by 100, then divide by total kilometers traveled.**

Keep a record for at least one month and record the type of driving (city or highway). This will provide an accurate estimate of the vehicle's fuel economy under current driving conditions. Additionally, keeping records during summer and winter will show how temperature impacts fuel economy. In general, lower temperatures give lower fuel economy.

### Driving style — good driving and fuel economy habits

Give consideration to the lists that follow and you may be able to change a number of variables and improve your fuel economy.

#### **Habits**

- Smooth, moderate operation can yield up to 10% savings in fuel.
- Steady speeds without stopping will usually give the best fuel economy.
- Idling for long periods of time (greater than one minute) may waste fuel.
- Anticipate stopping; slowing down may eliminate the need to stop.
- Sudden or hard accelerations may reduce fuel economy.
- Slow down gradually.
- Driving at reasonable speeds (traveling at 55 mph [88 km/h] uses 15% less fuel than traveling at 65 mph [105 km/h]).
- Revving the engine before turning it off may reduce fuel economy.
- Using the air conditioner or defroster may reduce fuel economy.

## Maintenance and Specifications

- You may want to turn off the speed control in hilly terrain if unnecessary shifting between the top gears occurs. Unnecessary shifting of this type could result in reduced fuel economy.
- Warming up a vehicle on cold mornings is not required and may reduce fuel economy.
- Resting your foot on the brake pedal while driving may reduce fuel economy.
- Combine errands and minimize stop-and-go driving.

### **Maintenance**

- Keep tires properly inflated and use only recommended size.
- Operating a vehicle with the wheels out of alignment will reduce fuel economy.
- Use recommended engine oil. Refer to *Maintenance product specifications and capacities* in this chapter.
- Perform all regularly scheduled maintenance items. Follow the recommended maintenance schedule and owner maintenance checks found in *scheduled maintenance information*.

### **Conditions**

- Heavily loading a vehicle or towing a trailer may reduce fuel economy at any speed.
- Carrying unnecessary weight may reduce fuel economy (approximately 1 mpg [0.4 km/L] is lost for every 400 lb [180 kg] of weight carried).
- Adding certain accessories to your vehicle (for example bug deflectors, rollbars/light bars, running boards, ski/luggage racks) may reduce fuel economy.
- Using fuel blended with alcohol may lower fuel economy.
- Fuel economy may decrease with lower temperatures during the first 8–10 miles (12–16 km) of driving.
- Driving on flat terrain offers improved fuel economy as compared to driving on hilly terrain.
- Transmissions give their best fuel economy when operated in the top cruise gear and with steady pressure on the gas pedal.
- Close windows for high speed driving.

## Maintenance and Specifications

### EMISSION CONTROL SYSTEM

 **WARNING:** Do not park, idle, or drive your vehicle in dry grass or other dry ground cover. The emission system heats up the engine compartment and exhaust system, which can start a fire.

 **WARNING:** Exhaust leaks may result in entry of harmful and potentially lethal fumes into the passenger compartment. If you smell exhaust fumes inside your vehicle, have your dealer inspect your vehicle immediately. Do not drive if you smell exhaust fumes.

Your vehicle is equipped with various emission control components and a catalytic converter which will enable your vehicle to comply with applicable exhaust emission standards. To make sure that the catalytic converter and other emission control components continue to work properly:

- Use only the specified fuel listed.
- Avoid running out of fuel.
- Do not turn off the ignition while your vehicle is moving, especially at high speeds.
- Have the items listed in *scheduled maintenance information* performed according to the specified schedule.

The scheduled maintenance items listed in *scheduled maintenance information* are essential to the life and performance of your vehicle and to its emissions system.

If other than Ford, Motorcraft® or Ford-authorized parts are used for maintenance replacements or for service of components affecting emission control, such non-Ford parts should be equivalent to genuine Ford Motor Company parts in performance and durability.

Illumination of the service engine soon indicator, charging system warning light or the temperature warning light, fluid leaks, strange odors, smoke or loss of engine power could indicate that the emission control system is not working properly.



An improperly operating or damaged exhaust system may allow exhaust to enter the vehicle. Have a damaged or improperly operating exhaust system inspected and repaired immediately.

## Maintenance and Specifications

Do not make any unauthorized changes to your vehicle or engine. By law, vehicle owners and anyone who manufactures, repairs, services, sells, leases, trades vehicles, or supervises a fleet of vehicles are not permitted to intentionally remove an emission control device or prevent it from working. Information about your vehicle's emission system is on the Vehicle Emission Control Information Decal located on or near the engine. This decal also lists engine displacement.



Please consult your *Warranty Guide* for complete emission warranty information.

### On-board diagnostics (OBD-II)

Your vehicle is equipped with a computer that monitors the engine's emission control system. This system is commonly known as the on-board diagnostics system (OBD-II). The OBD-II system protects the environment by ensuring that your vehicle continues to meet government emission standards. The OBD-II system also assists your authorized dealer in properly servicing your vehicle. When the service engine soon  indicator illuminates, the OBD-II system has detected a malfunction. Temporary malfunctions may cause the service engine soon  indicator to illuminate. Examples are:

1. The vehicle has run out of fuel—the engine may misfire or run poorly.
2. Poor fuel quality or water in the fuel—the engine may misfire or run poorly.
3. The fuel fill inlet may not have been properly closed. See *Easy Fuel*® “no cap” fuel system in this chapter.
4. Driving through deep water—the electrical system may be wet.

These temporary malfunctions can be corrected by filling the fuel tank with good quality fuel, properly closing the fuel fill inlet or letting the electrical system dry out. After three driving cycles without these or any other temporary malfunctions present, the service engine soon  indicator should stay off the next time the engine is started. A driving cycle consists of a cold engine startup followed by mixed city/highway driving. No additional vehicle service is required.



If the service engine soon  indicator remains on, have your vehicle serviced at the first available opportunity. Although some malfunctions detected by the OBD-II may not have symptoms that are apparent, continued driving with the service engine soon  indicator on can result in increased emissions, lower fuel economy, reduced engine and transmission smoothness, and lead to more costly repairs.

## Maintenance and Specifications

### Readiness for Inspection/Maintenance (I/M) testing

Some state/provincial and local governments may have Inspection/Maintenance (I/M) programs to inspect the emission control equipment on your vehicle. Failure to pass this inspection could prevent you from getting a vehicle registration. Your vehicle may not pass the I/M test if the service engine soon  indicator is on or not working properly (bulb is burned out), or if the OBD-II system has determined that some of the emission control systems have not been properly checked. In this case, the vehicle is considered not ready for I/M testing.

If the service engine soon  indicator is on or the bulb does not work, the vehicle may need to be serviced. Refer to *On-board diagnostics (OBD-II)* in this chapter.

If the vehicle's engine or transmission has just been serviced, or the battery has recently run down or been replaced, the OBD-II system may indicate that the vehicle is not ready for I/M testing. To determine if the vehicle is ready for I/M testing, turn the ignition key to the on position for 15 seconds without cranking the engine. If the service engine soon  indicator blinks eight times, it means that the vehicle is not ready for I/M testing; if the service engine soon  indicator stays on solid, it means that the vehicle is ready for I/M testing.

The OBD-II system is designed to check the emission control system during normal driving. A complete check may take several days. If the vehicle is not ready for I/M testing, the following driving cycle consisting of mixed city and highway driving may be performed:

15 minutes of steady driving on an expressway/highway followed by 20 minutes of stop-and-go driving with at least four 30-second idle periods.

Allow the vehicle to sit for at least eight hours without starting the engine. Then, start the engine and complete the above driving cycle. The engine must warm up to its normal operating temperature. Once started, do not turn off the engine until the above driving cycle is complete. If the vehicle is still not ready for I/M testing, the above driving cycle will have to be repeated.

## Maintenance and Specifications

### BRAKE/CLUTCH FLUID

Brake and clutch (if equipped) systems are supplied from the same reservoir.

The fluid level will drop slowly as the brakes wear, and will rise when the brake components are replaced.

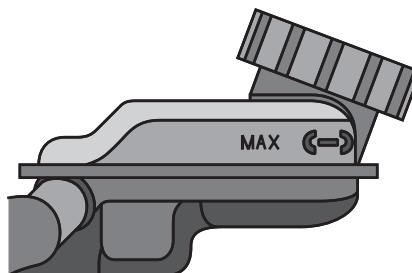

Fluid levels between the MIN and MAX lines are within the normal operating range; there is no need to add fluid.

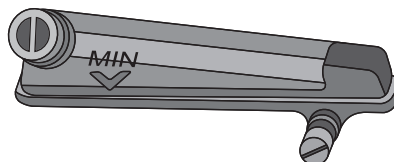

If the fluid levels are outside of the normal operating range, the performance of the system could be compromised; seek service from your authorized dealer immediately.

### TRANSMISSION FLUID

#### Checking 6-speed automatic transmission fluid

The automatic transmission does not have a transmission fluid dipstick.

Refer to your *scheduled maintenance information* for scheduled intervals for fluid checks and changes. Your transmission does not consume fluid. However, the fluid level should be checked if the transmission is not working properly, (i.e., if the transmission slips or shifts slowly) or if you notice some sign of fluid leakage.

**Transmission fluid should be checked by an authorized dealer. If required, fluid should be added by an authorized dealer.**

## Maintenance and Specifications

Do not use supplemental transmission fluid additives, treatments or cleaning agents. The use of these materials may affect transmission operation and result in damage to internal transmission components.

### Checking 5-speed manual transmission fluid (if equipped)

The manual transmission does not have a transmission fluid dipstick.

1. Clean the filler plug.
2. Remove the filler plug and inspect the fluid level.
3. Fluid level should be at the bottom of the opening.
4. Add enough fluid through the filler opening so that the fluid level is 5-10 mm below the bottom of the opening.
5. Install and tighten the fill plug securely.

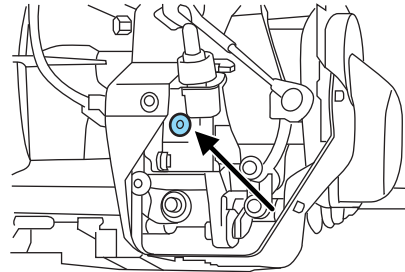

Use only fluid that meets Ford specifications. Refer to the *Maintenance product specifications and capacities* section in this chapter.

### AIR FILTER

Refer to *scheduled maintenance information* for the appropriate intervals for changing the air filter element.

When changing the air filter element, use only the air filter element listed. Refer to *Motorcraft® part numbers* in this chapter.



**WARNING:** To reduce the risk of vehicle damage and/or personal burn injuries do not start your engine with the air cleaner removed and do not remove it while the engine is running.



## Maintenance and Specifications

### Changing the air filter element

1. Remove the four screws that secure the air filter housing cover.
2. Carefully separate the two halves of the air filter housing.
3. Remove the air filter element from the air filter housing.
4. Wipe the air filter housing and cover clean to remove any dirt or debris and to ensure good sealing.
5. Install a new air filter element. Be careful not to crimp the filter element edges between the air filter housing and cover. This could cause filter damage and allow unfiltered air to enter the engine if not properly seated.
6. Replace the air filter housing cover and install the screws.

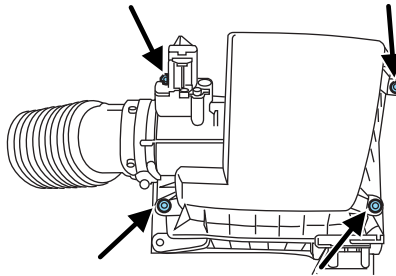

**Note:** Failure to use the correct air filter element may result in severe engine damage. The customer warranty may be void for any damage to the engine if the correct air filter element is not used.

### VEHICLE STORAGE

If you plan on storing your vehicle for an extended period of time (30 days or more), refer to the following maintenance recommendations to ensure your vehicle stays in good operating condition.

All motor vehicles and their components were engineered and tested for reliable, regular driving. Long term storage under various conditions may lead to component degradation or failure unless specific precautions are taken to preserve the components.

#### *General*

- Store all vehicles in a dry, ventilated place.
- Protect from sunlight, if possible.
- If vehicles are stored outside, they require regular maintenance to protect against rust and damage.

#### *Body*

- Wash vehicle thoroughly to remove dirt, grease, oil, tar or mud from exterior surfaces, rear-wheel housing and underside of front fenders. See the *Cleaning* chapter for more information.
- Periodically wash vehicles stored in exposed locations.

## Maintenance and Specifications

- Touch-up raw or primed metal to prevent rust.
- Cover chrome and stainless steel parts with a thick coat of auto wax to prevent discoloration. Re-wax as necessary when the vehicle is washed. See the *Cleaning* chapter for more information.
- Lubricate all hood, door and trunk lid hinges, and latches with a light grade oil. See the *Cleaning* chapter for more information.
- Cover interior trim to prevent fading.
- Keep all rubber parts free from oil and solvents.

### *Engine*

- The engine oil and filter should be changed prior to storage, as used engine oil contain contaminants that may cause engine damage.
- Start the engine every 15 days. Run at fast idle until it reaches normal operating temperature.
- With your foot on the brake, shift through all the gears while the engine is running.

### *Fuel system*

- Fill the fuel tank with high-quality fuel until the first automatic shutoff of the fuel pump nozzle.

**Note:** During extended periods of vehicle storage (30 days or more), fuel may deteriorate due to oxidation. Add a quality gas stabilizer product to the vehicle fuel system whenever actual or expected storage periods exceed 30 days. Follow the instructions on the additive label. The vehicle should then be operated at idle speed to circulate the additive throughout the fuel system.

### *Cooling system*

- Protect against freezing temperatures.
- When removing vehicle from storage, check coolant fluid level. Confirm there are no cooling system leaks, and fluid is at the recommended level.

### *Battery*

- Check and recharge as necessary. Keep connections clean.
- If storing your vehicle for more than 30 days without recharging the battery, it may be advisable to disconnect the battery cables to ensure battery charge is maintained for quick starting.

**Note:** If battery cables are disconnected, it will be necessary to reset memory features.

## Maintenance and Specifications

### *Brakes*

- Make sure brakes and parking brake are fully released.

### *Tires*

- Maintain recommended air pressure.

### *Miscellaneous*

- Make sure all linkages, cables, levers and pins under vehicle are covered with grease to prevent rust.
- Move vehicles at least 25 feet (8 m) every 15 days to lubricate working parts and prevent corrosion.

### *Removing vehicle from storage*

When your vehicle is ready to come out of storage, do the following:

- Wash your vehicle to remove any dirt or grease film build-up on window surfaces.
- Check windshield wipers for any deterioration.
- Check under the hood for any foreign material that may have collected during storage (mice/squirrel nests).
- Check the exhaust for any foreign material that may have collected during storage.
- Check tire pressures and set tire inflation per the Tire Label.
- Check brake pedal operation. Drive the vehicle 15 ft (4.5 meters) back and forth to remove rust build-up.
- Check fluid levels (including coolant, oil and gas) to make sure there are no leaks, and fluids are at recommended levels.
- If the battery was removed, clean the battery cable ends and inspect.

Contact your authorized dealer if you have any concerns or issues.

## Maintenance and Specifications

### MOTORCRAFT® PART NUMBERS

Component	1.6L engine
Air filter element	FA-1904
Oil filter	FL-910S <sup>1</sup>
Battery	BXT-96R-500
Spark plugs	<sup>2</sup>
Cabin air filter	FP69
Windshield wiper blade	WW-2601-PF (driver side) WW-1601-PF (passenger side)

<sup>1</sup>Only use the specified replacement oil filter. The use of a non-specified oil filter can result in engine damage.

<sup>2</sup>For spark plug replacement, see your authorized dealer. Refer to *scheduled maintenance information* for the appropriate intervals for changing the spark plugs.

**Replace the spark plugs with ones that meet Ford material and design specifications for your vehicle, such as Motorcraft® or equivalent replacement parts. The customer warranty may be void for any damage to the engine if such spark plugs are not used.**

## Maintenance and Specifications

### MAINTENANCE PRODUCT SPECIFICATIONS AND CAPACITIES

Item	Capacity	Ford Part Name or Equivalent	Ford Part Number / Ford Specification
Brake/Clutch fluid	Top-off to MAX line on reservoir	Motorcraft® High Performance DOT 3 Motor Vehicle Brake Fluid	PM-1-C / WSS-M6C62-A or WSS-M6C65-A1
Door latch, hood latch, auxiliary hood latch, trunk latch, seat tracks.	—	Multi-Purpose Grease (Lithium grease)	XG-4 or XL-5 or equivalent / ESB-M1C93-B
Lock cylinder	—	Motorcraft® Penetrating and Lock Lubricant	XL-1 / None
Manual transmission fluid	2.2 quarts (2.1L)	Motorcraft® Full Synthetic Manual Transmission Fluid	XT-M5-QS / WSD-M2C200-C
Automatic transmission fluid	1.8 quarts (1.7L)	Motorcraft® Dual Clutch Transmission Fluid	XT-11-QDC / WSS-M2C200-D2

<https://www.MyCarManual.com>

## Maintenance and Specifications

Item	Capacity	Ford Part Name or Equivalent	Ford Part Number / Ford Specification
Engine oil	4.2 quarts (4.0L) (with filter change)	<ul style="list-style-type: none"> <li>•Motorcraft® SAE 5W-20 Premium Synthetic Blend Motor Oil (US)</li> <li>•Motorcraft® SAE 5W-20 Full Synthetic Motor Oil (US)</li> <li>•Motorcraft® SAE 5W-20 Super Premium Motor Oil (Canada)</li> <li>•Motorcraft® SAE 5W-20 Synthetic Motor Oil (Canada)<sup>1</sup></li> </ul>	<ul style="list-style-type: none"> <li>•XO-5W20-QSP (US)</li> <li>•XO-5W20-QFS (US)</li> <li>•CXO-5W20-LSP12 (Canada)</li> <li>•CXO-5W20-LFS12 (Canada)</li> </ul> / WSS-M2C945 -A and API Certification Mark
Engine coolant	5.8 quarts (5.5L)	Motorcraft® Specialty Orange Engine Coolant <sup>2</sup>	<ul style="list-style-type: none"> <li>•VC-3-B (US)</li> <li>•CVC-3-B (Canada) / WSS-M97B44-D</li> </ul>
Windshield washer fluid	Fill as required	Motorcraft® Premium Windshield Washer Concentrate (US) Premium Quality Windshield Washer Fluid (Canada)	ZC-32-A (US) CXC-37-(A, B, D, and F) (Canada) / WSB-M8B16-A2/- -
Fuel tank	12.4 gallons (47L)	—	—

<sup>1</sup> Refer to *Engine oil and filter recommendations* in this chapter for more information.

<sup>2</sup> Add the coolant type originally equipped in your vehicle.

## Maintenance and Specifications

### ENGINE DATA

Engine	1.6L engine
Cubic inches	97
Required fuel	Minimum 87 octane
Firing order	1-3-4-2
Ignition system	Distributorless Ignition System (D.I.S.)
Compression ratio	11:1
Spark plug gap	.029 -.033 inch (0.75 - 0.85 mm)

## Maintenance and Specifications

### Engine drivebelt routing

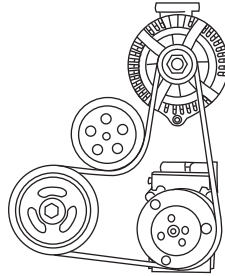

### IDENTIFYING YOUR VEHICLE

#### Safety Compliance Certification Label

The National Highway Traffic Safety Administration Regulations require that a Safety Compliance Certification Label be affixed to a vehicle and prescribe where the Safety Compliance Certification Label may be located. The Safety Compliance Certification Label is located on the structure (B-Pillar) by the trailing edge of the driver's door or the edge of the driver's door.

MFD. BY FORD MOTOR CO.						
DATE: XX/XX	GVWR: XXXXXLB/ XXXXXKG					
FRONT GAWR: XXXXL	REAR GAWR: XXXXLB					
XXXXKG	WITH	XXXXKG	WITH			
XXXX/XX.XXXXX	TIRES	XXXX/XXXXXXX	TIRES			
XXXX.XX	RIMS	XXXX.XX	RIMS			
AT XXX kPa/XX	PSI COLD	AT XXX kPa/XX	PSI COLD			
THIS VEHICLE CONFORMS TO ALL APPLICABLE FEDERAL MOTOR VEHICLE SAFETY STANDARDS IN EFFECT ON THE DATE OF MANUFACTURE SHOWN ABOVE.						
VIN: XXXXXXXXXXXXXXXXX	XXXXXX		XXXXXX			
TYPE: XXX						
EXT PNT: XX	RC: XX	DSO:				
WB 1	INT TR	TP/PS	R	AXLE	TR SPR	XXXXXX
XXX	XX	X	XX	X XX	XXX	
XXXXXXXXXXXXX XXX XXXX-XXXXXX-XX						



## Maintenance and Specifications

### Vehicle identification number (VIN)

The vehicle identification number is located on the driver side instrument panel.

Please note that in the graphic, XXXX is representative of your vehicle identification number.

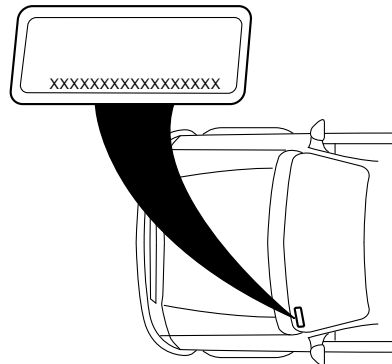

The Vehicle Identification Number (VIN) contains the following information:

1. World manufacturer identifier
2. Brake system / Gross Vehicle Weight Rating (GVWR) / Restraint Devices and their location
3. Make, vehicle line, series, body type
4. Engine type
5. Check digit
6. Model year
7. Assembly plant
8. Production sequence number

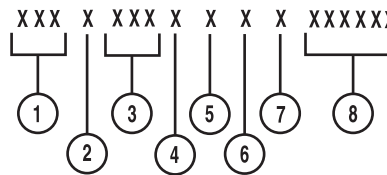

## Maintenance and Specifications

### TRANSMISSION CODE DESIGNATIONS

You can find a transmission code on the Safety Compliance Certification Label. The following table tells you which transmission each code represents.

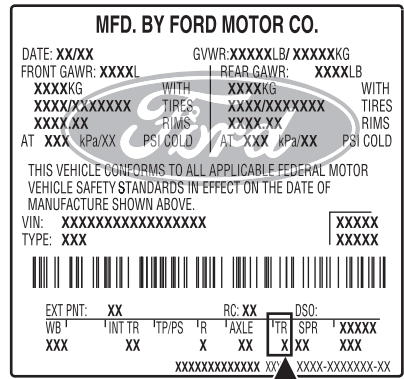

Description	Code
Five-speed manual transmission	C
Six-speed automatic transmission	A

## Accessories

### FORD CUSTOM ACCESSORIES FOR YOUR VEHICLE

A wide selection of Ford Custom Accessories are available for your vehicle through your local Ford or Ford of Canada dealer. These quality accessories have been specifically engineered to fulfill your automotive needs; they are custom designed to complement the style and aerodynamic appearance of your vehicle. In addition, each accessory is made from high quality materials and meets or exceeds Ford's rigorous engineering and safety specifications. Ford Motor Company will repair or replace any properly dealer-installed Ford Custom Accessories found to be defective in factory-supplied materials or workmanship during the warranty period, as well as any component damaged by the defective accessories. The accessories will be warranted for whichever provides you the greatest benefit:

- 12 months or 12,000 miles (20,000 km) (whichever occurs first), or
- the remainder of your new vehicle limited warranty.

Contact your dealer for details and a copy of the warranty.

The following is a list of several Ford Custom Accessories. Not all accessories are available for all models. For a complete listing of the accessories that are available for your vehicle, please contact your dealer or visit our online store at: **[www.fordaccessories.com](http://www.fordaccessories.com)** (U.S. only).

#### Exterior style

- Bug shields
- Deflectors
- Graphics kit
- Splash guards
- Spoilers
- Wheels
- Rear bumper protector
- Body kit\*

#### Interior style

- Ambient lighting kit
- Floor mats
- Lighted sill plates
- Illuminated shift knob\*
- Arm rest\*

#### Lifestyle

- Ash cup / smoker's package
- Roof racks and carriers\*
- Garmin navigation\*
- Cargo net\*

## Accessories

### Peace of mind

- Keyless entry keypad
- Remote start
- Wheel locks
- Bumper mounted parking sensors\*
- Seat covers\*
- Car covers\*

\*Ford Licensed Accessories (FLA) are warranted by the accessory manufacturer's warranty. Ford Licensed Accessories are fully designed and developed by the accessory manufacturer and have not been designed or tested to Ford Motor Company engineering requirements. Contact your Ford dealer for details regarding the manufacturer's limited warranty and/or a copy of the FLA product limited warranty offered by the accessory manufacturer.

For maximum vehicle performance, keep the following information in mind when adding accessories or equipment to your vehicle:

- When adding accessories, equipment, passengers and luggage to your vehicle, do not exceed the total weight capacity of the vehicle or of the front or rear axle (GVWR or GAWR as indicated on the Safety Compliance Certification label). Consult your authorized dealer for specific weight information.
- The Federal Communications Commission (FCC) and Canadian Radio Telecommunications Commission (CRTC) regulate the use of mobile communications systems — such as two-way radios, telephones and theft alarms - that are equipped with radio transmitters. Any such equipment installed in your vehicle should comply with FCC or CRTC regulations and should be installed only by a qualified service technician.
- Mobile communications systems may harm the operation of your vehicle, particularly if they are not properly designed for automotive use.
- To avoid interference with other vehicle functions, such as anti-lock braking systems, amateur radio users who install radios and antennas onto their vehicle should not locate the amateur radio antennas in the area of the driver's side hood.
- Any non-Ford custom electrical or electronic accessories or components that are added to the vehicle by the authorized dealer or the owner, may adversely affect battery performance and durability, and may also adversely affect the performance of other electrical systems in the vehicle.

## Ford Extended Service Plan

### **FORD ESP EXTENDED SERVICE PLANS (U.S. ONLY)**

More than 32 million Ford and Lincoln owners have discovered the powerful protection of Ford ESP. It is the only extended service plan backed by Ford Motor Company, and provides “peace of mind” protection beyond the New Vehicle Limited Warranty coverage.

#### ***Up to 500+ Covered Vehicle Components***

There are four, new-vehicle Extended Service Plans with different levels of coverage. Ask your dealer for details.

**PremiumCare** – Our most comprehensive coverage. With over 500 covered components, this plan is so complete that we generally only discuss what’s not covered!

**ExtraCare** – Covers 113 components, and includes many high-tech items.

**BaseCare** – Covers 84 components.

**PowertrainCare** – Covers 29 critical components.

**Ford ESP is honored by all Ford and Lincoln Dealers in the U.S. and Canada** It’s the only extended service plan authorized and backed by Ford Motor Company. That means you get:

- Reliable, quality service anywhere you go.
- **Factory-trained technicians.**
- **Ford Authorized Parts used with every covered repair.**

#### ***Rental car reimbursement***

**If your vehicle is kept overnight for covered repairs**, you are eligible for rental car coverage, including Bumper-to-Bumper warranty repairs, or manufacturer’s recalls.

#### ***Transferable coverage***

If you sell your vehicle before your Ford ESP coverage expires, you can transfer any remaining coverage to the new owner. Whenever you’re ready to sell your car, prospective buyers may feel better about taking a risk on your used vehicle. Ford ESP may add resale value!

Plus, **exclusive 24/7 roadside assistance**, including:

- Towing, flat-tire change and battery jump starts.
- Out-of-fuel and lock-out assistance.
- Travel expense reimbursement for lodging, meals and rental car.
- Destination assistance for taxi, shuttle, rental car coverage and emergency transportation.

## Ford Extended Service Plan

### ***Ford ESP Can Quickly Pay for Itself***

One service bill – the cost of parts and labor – can easily exceed the price of your Ford ESP Service Contract. With Ford ESP, you minimize your risk for unexpected repair bills and rising repair costs.

### ***Avoid the rising cost of properly maintaining your vehicle!***

Ford ESP also offers a Premium Maintenance Plan that covers items that **routinely wear out**.

The coverage is prepaid, so you never have to worry about affording your vehicle maintenance. It covers regular checkups, routine inspections, preventive care and replacement of items that require periodic attention for **normal “wear”**:

- **Wiper blades**
- **Spark plugs (except California)**
- **Clutch disc**
- **Brake pads and linings**
- **Shock absorbers**
- **Belts and hoses**

Contact your selling Ford or Lincoln dealership today so they can customize a Ford Extended Service Plan that fits your driving lifestyle and budget.

### ***Interest free finance options available***

Take advantage of our installment payment plan, just a 10% down payment will provide you with an affordable no interest, no-fee payment opportunity.

## Ford Extended Service Plan

-----  
***Get Genuine Peace of Mind with Ford ESP!***

To learn more, complete the information below and mail this to:

**Ford ESP  
P.O. Box 8072  
Royal Oak, MI 48068-9933**

NAME (PLEASE PRINT) \_\_\_\_\_

ADDRESS \_\_\_\_\_ APT.NO. \_\_\_\_\_

CITY \_\_\_\_\_ STATE \_\_\_\_\_ ZIP \_\_\_\_\_

E-MAIL: \_\_\_\_\_

## Ford Extended Service Plan

### FORD ESP EXTENDED SERVICE PLANS (CANADA ONLY)

You can get more protection for your vehicle by purchasing a Ford Extended Service Plan (ESP). Ford ESP is the only service contract backed by Ford Motor Company of Canada, Limited. Depending on the plan you purchase, Ford ESP provides benefits such as:

- Rental reimbursement
- Coverage for certain maintenance and wear items
- Protection against repair costs after your New Vehicle Limited Warranty Coverage expires
- Roadside Assistance benefits

There are several Ford ESP plans available in various time, distance and deductible combinations. Each plan is tailored to fit your own driving needs, including reimbursement for towing and rental.

When you purchase Ford ESP, you receive added peace-of-mind protection throughout Canada and the United States, provided by a network of participating Ford Motor Company dealers.

For more information, visit your local Ford of Canada dealer or [www.ford.ca](http://www.ford.ca) to find the Ford Extended Service Plan that is right for you.

**Note:** Repairs performed outside of Canada and the United States are not eligible for Ford ESP coverage.



## Scheduled Maintenance

### GENERAL MAINTENANCE INFORMATION

#### Why maintain your vehicle?

Carefully following this schedule helps protect against major repair expenses resulting from neglect or inadequate maintenance and may also help to increase the value of your vehicle when you sell or trade it.

It is your responsibility to see that all scheduled maintenance is performed and that the materials used meet Ford engineering specifications as identified in the *Maintenance and Specifications* chapter. Failure to perform scheduled maintenance specific in this guide will invalidate warranty coverage on parts affected by the lack of maintenance. Be sure receipts for completed maintenance are kept with the vehicle and confirmation of the work performed is always recorded in this guide.

Your dealer has factory-trained technicians who can perform the required maintenance using genuine Ford parts. They are committed to meeting your service needs and to assuring your continuing satisfaction.

#### Protecting your investment

Maintenance is an investment that will pay dividends in the form of improved reliability, durability and resale value. To maintain the proper performance of your vehicle and its emission control systems, it is imperative that scheduled maintenance be completed at the designated intervals.

Your vehicle is equipped with a message center which displays a message at the proper oil change service interval; the interval is one year or 10,000 miles (16,000 km) under normal driving conditions. When ENGINE OIL CHANGE DUE NEXT SERVICE or OIL CHANGE REQUIRED appears in the message center display, it's time for an oil change; the oil change must be done within two weeks or 500 miles (800 km) of the ENGINE OIL CHANGE DUE NEXT SERVICE or OIL CHANGE REQUIRED message appearing. The oil minder system must be reset after each oil change; refer to the *Instrument Cluster* chapter.

If your message center is prematurely reset or becomes inoperative, you should perform the oil change interval at six months or 5,000 miles (8,000 km) from your last oil change.

## Scheduled Maintenance

Your vehicle is very sophisticated and built with multiple complex performance systems. Every manufacturer develops these systems using different specifications and performance features. That's why it's important to rely upon your dealership to properly diagnose and repair your vehicle.

Ford Motor Company has recommended maintenance intervals for various parts and component systems based upon engineering testing. Ford Motor Company relies upon this testing to determine the most appropriate mileage for replacement of oils and fluids to protect your vehicle at the lowest overall cost to you and recommends against maintenance schedules that deviate from the scheduled maintenance information.

Ford strongly recommends the use of genuine Ford replacement parts. Parts other than Ford, Motorcraft® or Ford-authorized remanufactured parts that are used for maintenance replacement or for the service of components affecting emission control must be equivalent to genuine Ford Motor Company parts in performance and durability. It is the owner's responsibility to determine the equivalency of such parts. Please consult your *Warranty Guide* for complete warranty information.

Chemicals or additives not approved by Ford are not required for factory recommended maintenance. In fact, Ford Motor Company recommends against the use of such additive products unless specifically recommended by Ford for a particular application.

### ***Oils, fluids and flushing***

In many cases, fluid discoloration is a normal operating characteristic and, by itself, does not necessarily indicate a concern or that the fluid needs to be changed. However, discolored fluids that also show signs of overheating and/or foreign material contamination should be inspected immediately by a qualified expert such as the factory-trained technicians at your dealership. Your vehicle's oils and fluids should be changed at the specified intervals or in conjunction with a repair. Flushing is a viable way to change fluid for many vehicle sub-systems during scheduled maintenance. It is critical that systems are flushed only with new fluid that is the same as that required to fill and operate the system, or using a Ford-approved flushing chemical.

## Scheduled Maintenance

### **Genuine Ford parts and service**

When planning your maintenance services, consider your dealership for all your vehicle's needs.

There are a lot of reasons why visiting your dealership for all your service needs is a great way to help keep your vehicle running great.

#### ***Convenience***

Many dealerships have extended evening and Saturday hours to make your service visit more convenient. How's that for quality service?

#### ***Factory-trained technicians***

Service technicians participate in extensive factory-sponsored certification training to help them become experts on the operation of your vehicle. Ask your dealership about the training and certification their technicians have received.

#### ***Genuine Ford and Motorcraft® replacement parts***

Dealerships stock Ford and Motorcraft® branded replacement parts. These parts meet or exceed Ford Motor Company's specifications, and we stand behind them. Parts installed at your dealership carry a nationwide, 12 month/12,000 mile (20,000 km) parts and labor limited warranty. Your dealer can give you details.

#### ***Value shopping for your vehicle's maintenance needs***

Your dealership recognizes the competitive landscape of maintenance and light repair automotive services. With factory-trained technicians, and one-stop service from routine maintenance like oil changes and tire rotations to repairs like brake service, check out the value your dealers can offer.

## Scheduled Maintenance

### Owner Checks and Services

Certain basic maintenance checks and inspections should be performed by the owner or a service technician at the intervals indicated. Service information and supporting specifications are provided in this owner's guide.

Any adverse condition should be brought to the attention of your dealer or qualified service technician as soon as possible for the proper service advice. The owner maintenance service checks are generally not covered by warranties so you may be charged for labor, parts or fluids used.

<b>Engine oil/coolant change intervals</b>	
<b>Engine oil</b>	As indicated by the message center: do not exceed one year or 10,000 miles (16,000 km)
<b>Engine coolant, initial change</b>	6 years or 100,000 miles (160,000 km) (whichever comes first)
<b>Engine coolant, after initial change</b>	Every 3 years or 50,000 miles (80,000 km)
<b>Check every month</b>	
Engine oil level	
Function of all interior and exterior lights	
Tires for wear and proper pressure, including spare	
Windshield washer fluid level	
<b>Check every six months</b>	
Battery connections; clean if necessary	
Body and door drain holes for obstructions; clean if necessary	
Cooling system fluid level and coolant strength	
Door weatherstrips for wear; lubricate if necessary	
Hinges/latches/outside locks for proper operation; lubricate if necessary	
Parking brake for proper operation	
Safety belts and seat latches for wear and function	
Safety warning lamps (brake, ABS, airbag, safety belt) for operation	
Washer spray/wiper operation; clean or replace blades as necessary	

## Scheduled Maintenance

### Multi-Point Inspection

In order to keep your vehicle running right, it is important to have the systems on your vehicle checked regularly. This can help identify potential issues and prevent major problems. Ford Motor Company recommends the following multi-point inspection be performed at every scheduled maintenance interval to help make sure your vehicle keeps running great.

<b>Multi-point inspection – Recommended each visit</b>	
Accessory drive belt(s)	Half-shaft dust boots (if equipped)
Battery performance	Horn operation
Clutch operation (if equipped)	Radiator, cooler, heater and A/C hoses
Engine air filter	Suspension component for leaks or damage
Exhaust system	Steering and linkage
Exterior lamps and hazard warning system operation	Tires for wear and proper pressure, including spare
Fluid levels*; fill if necessary	Windshield for cracks, chips or pits
For oil and fluid leaks	Washer spray and wiper operation
*Brake, coolant recovery reservoir, manual and automatic transmission (with an underhood dipstick), power steering (if equipped) and window washer	

Be sure to ask your dealership service advisor or technician about the multi-point vehicle inspection. It's a comprehensive way to perform a thorough inspection of your vehicle. It's your checklist that gives you immediate feedback on the overall condition of your vehicle. You'll know what's been checked, what's okay, as well as those things that may require future or immediate attention. The multi-point vehicle inspection is one more way to keep your vehicle running great!

# Scheduled Maintenance

Owner's Member #: \_\_\_\_\_  
 Owner's Service Balance: \_\_\_\_\_

**Multi-Point Inspection Report Card as Recommended by Ford Motor Company**

Make: \_\_\_\_\_ Model/Year: \_\_\_\_\_ Mileage: \_\_\_\_\_

Days: \_\_\_\_\_ Mile: \_\_\_\_\_ Static Inspection Month: \_\_\_\_\_

**SCHEDULED MAINTENANCE ITEMS DUE FOR SERVICES ON THIS VEHICLE**

ITEM	STATUS	ITEM	STATUS
Cabin Air Filter	<input type="checkbox"/>	Oil Filter	<input type="checkbox"/>
Engine Air Filter	<input type="checkbox"/>	Spark Plugs	<input type="checkbox"/>
Engine Coolant	<input type="checkbox"/>	Tire Rotation	<input type="checkbox"/>
Flux Filter	<input type="checkbox"/>	Transmission Fluid	<input type="checkbox"/>
Oil Change	<input type="checkbox"/>		

\*This is only a partial list of vehicle maintenance items and is NOT all-inclusive. Please consult your Owner's Manual or visit www.genuineford.com for vehicle specific maintenance requirements.

**CHECK FLUID LEVELS AND FILL**

ITEM	STATUS	ITEM	STATUS
Oil and/or fluid leaks	<input type="checkbox"/>	Power Steering	<input type="checkbox"/>
Wash/Wax	<input type="checkbox"/>	Windshield Washer	<input type="checkbox"/>
Battery	<input type="checkbox"/>	Social Security Database	<input type="checkbox"/>

**State of Health** Condition of \_\_\_\_\_

Factory spec cold cranking amps  Antilock Braking System

**EXTERIOR BODY**

Note any existing exterior body damage or defects:

**TIRES/ BRAKE WEAR**

TIRES	THICKNESS	WORN	THICKNESS	WORN
FRONT LEFT	_____ /32"	<input type="checkbox"/>	FRONT RIGHT	_____ /32"
FRONT CENTER	_____ /32"	<input type="checkbox"/>	FRONT REAR	_____ /32"
FRONT RIGHT	_____ /32"	<input type="checkbox"/>	REAR LEFT	_____ /32"
REAR CENTER	_____ /32"	<input type="checkbox"/>	REAR RIGHT	_____ /32"

**Comments:** \_\_\_\_\_

Service Advisor: \_\_\_\_\_ Customer Signature: \_\_\_\_\_

Technician: \_\_\_\_\_ Customer Copy

12-XXXXXXX

**SYNC VEHICLE HEALTH REPORT (VHR)**

VHR Available:  Yes  No

**CHECK FOLLOWING SYSTEMS**

**STEERING & SHOCKS**

Steering system (steering lines, hoses, including brake)

Shock absorbers (steering lines, hoses, including brake)

**EXHAUST SYSTEM**

Exhaust system (leaks, damage, loose parts)

**DRIVESHIFT AND DRIVE AXLE**

Driveshaft (leak, noise, vibration)

**LIGHTS/BLADES/WINDSHIELD**

Operation of front, marker, light, exterior lamps, turn signals, hazard and brake lamps

Windshield for cracks, chips and pitting

**BELTS AND BUSHINGS**

HWAC system and hoses/belts/boots and/or damage

Engine Cooling system, radiator, hoses and clamps

Accessory drive belt(s)

## Scheduled Maintenance

### NORMAL SCHEDULED MAINTENANCE AND LOG

Your vehicle is equipped with a oil minder system that indicates when the engine oil should be changed under normal operating conditions. This means you won't have to remember to change the oil on a mileage-based schedule; the vehicle lets you know when an oil change is due by displaying ENGINE OIL CHANGE DUE NEXT SERVICE or OIL CHANGE REQUIRED in the message center.

Normal Scheduled Maintenance	
Every 10,000 miles (16,000 km) or 12 months	Change engine oil and filter
	Rotate tires, inspect tire wear and measure tread depth
	Perform multi-point inspection (recommended)
	Inspect automatic transmission fluid level (if equipped with dipstick); consult dealer for requirements
	Inspect brake pads, shoes, rotors, drums, brake linings, hoses and parking brake
	Inspect cabin air filter (if equipped)
	Inspect engine cooling system strength and hoses (non-hybrid vehicles)
	Inspect engine cooling system and motor/electronics cooling system strength and hoses (hybrid vehicles)
	Inspect exhaust system and heat shields
	Inspect half-shaft boots (if equipped)
	Inspect rear axle and U-joints; lubricate if equipped with grease fittings (AWD vehicles)
	Inspect steering linkage, ball joints, suspension, tie-rod ends, driveshaft and U-joints; lubricate if equipped with grease fittings
	Inspect wheels and related components for abnormal noise, wear, looseness or drag
Reset your oil minder system after each engine oil and filter change; refer to the <i>Instrument Cluster</i> chapter	
<b>Do not exceed one year or 10,000 miles (16,000 km) between service intervals</b>	

## Scheduled Maintenance

Additional maintenance items <sup>1</sup>													
Miles (x 1,000)	20	30	40	60	80	90	100	120	140	150			
Kilometers (x 1,000)	32	48	64	96	128	144	160	192	225	240			
Replace cabin air filter (if equipped)	•		•	•	•		•	•	•				
Replace climate-controlled seat filter (if equipped)		•		•		•		•					•
Replace engine air filter (except Fusion Hybrid and MKZ Hybrid) <sup>2</sup>		•		•		•		•					•
Change engine coolant <sup>3</sup>											•		
Change motor/electronics coolant (hybrid vehicles only) <sup>3</sup>											•		
Replace spark plugs											•		
Inspect accessory drive belt(s)											•		
Change transmission fluid (Fiesta)													•
Replace accessory drive belt(s) if not replaced within the last 100,000 miles (160,000 km)													•
Replace timing belt if not replaced within the last 150,000 miles (240,000 km) or 10 years (Fiesta); <b>failure to replace belt can cause internal engine damage</b>													•

<sup>1</sup> Additional maintenance items can be performed within 3,000 miles (4,800 km) of the last oil change. Do not exceed the designated distance for the interval.

<sup>2</sup> Fusion Hybrid and MKZ Hybrid vehicles have an engine air filter that does not normally require replacement. Refer to *Air filter* in the *Maintenance and Specifications* chapter for more information.

<sup>3</sup> Initial replacement at 6 years or 100,000 miles (160,000 km), then every 3 years or 50,000 miles (80,000 km)



## Scheduled Maintenance

### Maintenance Schedule Log

<p style="text-align: center;">DEALER VALIDATION:</p> <p>RO#:            P&amp;A CODE:                            HOURS:          DATE:         MILEAGE:</p>	<p style="text-align: center;">DEALER VALIDATION:</p> <p>RO#:            P&amp;A CODE:                            HOURS:          DATE:         MILEAGE:</p>
<p style="text-align: center;">DEALER VALIDATION:</p> <p>RO#:            P&amp;A CODE:                            HOURS:          DATE:         MILEAGE:</p>	<p style="text-align: center;">DEALER VALIDATION:</p> <p>RO#:            P&amp;A CODE:                            HOURS:          DATE:         MILEAGE:</p>
<p style="text-align: center;">DEALER VALIDATION:</p> <p>RO#:            P&amp;A CODE:                            HOURS:          DATE:         MILEAGE:</p>	<p style="text-align: center;">DEALER VALIDATION:</p> <p>RO#:            P&amp;A CODE:                            HOURS:          DATE:         MILEAGE:</p>
<p style="text-align: center;">DEALER VALIDATION:</p> <p>RO#:            P&amp;A CODE:                            HOURS:          DATE:         MILEAGE:</p>	<p style="text-align: center;">DEALER VALIDATION:</p> <p>RO#:            P&amp;A CODE:                            HOURS:          DATE:         MILEAGE:</p>
<p style="text-align: center;">DEALER VALIDATION:</p> <p>RO#:            P&amp;A CODE:                            HOURS:          DATE:         MILEAGE:</p>	<p style="text-align: center;">DEALER VALIDATION:</p> <p>RO#:            P&amp;A CODE:                            HOURS:          DATE:         MILEAGE:</p>

## Scheduled Maintenance

<p style="text-align: center;">DEALER VALIDATION:</p>  <p style="text-align: center;">P&amp;A CODE:</p> <p>RO#:            HOURS:</p> <p>DATE:           MILEAGE:</p>	<p style="text-align: center;">DEALER VALIDATION:</p>  <p style="text-align: center;">P&amp;A CODE:</p> <p>RO#:            HOURS:</p> <p>DATE:           MILEAGE:</p>
<p style="text-align: center;">DEALER VALIDATION:</p>  <p style="text-align: center;">P&amp;A CODE:</p> <p>RO#:            HOURS:</p> <p>DATE:           MILEAGE:</p>	<p style="text-align: center;">DEALER VALIDATION:</p>  <p style="text-align: center;">P&amp;A CODE:</p> <p>RO#:            HOURS:</p> <p>DATE:           MILEAGE:</p>
<p style="text-align: center;">DEALER VALIDATION:</p>  <p style="text-align: center;">P&amp;A CODE:</p> <p>RO#:            HOURS:</p> <p>DATE:           MILEAGE:</p>	<p style="text-align: center;">DEALER VALIDATION:</p>  <p style="text-align: center;">P&amp;A CODE:</p> <p>RO#:            HOURS:</p> <p>DATE:           MILEAGE:</p>
<p style="text-align: center;">DEALER VALIDATION:</p>  <p style="text-align: center;">P&amp;A CODE:</p> <p>RO#:            HOURS:</p> <p>DATE:           MILEAGE:</p>	<p style="text-align: center;">DEALER VALIDATION:</p>  <p style="text-align: center;">P&amp;A CODE:</p> <p>RO#:            HOURS:</p> <p>DATE:           MILEAGE:</p>
<p style="text-align: center;">DEALER VALIDATION:</p>  <p style="text-align: center;">P&amp;A CODE:</p> <p>RO#:            HOURS:</p> <p>DATE:           MILEAGE:</p>	<p style="text-align: center;">DEALER VALIDATION:</p>  <p style="text-align: center;">P&amp;A CODE:</p> <p>RO#:            HOURS:</p> <p>DATE:           MILEAGE:</p>

## Scheduled Maintenance

<p style="text-align: center;">DEALER VALIDATION:</p> <p>RO#: P&amp;A CODE:            DATE: HOURS:            MILEAGE:</p>	<p style="text-align: center;">DEALER VALIDATION:</p> <p>RO#: P&amp;A CODE:            DATE: HOURS:            MILEAGE:</p>
<p style="text-align: center;">DEALER VALIDATION:</p> <p>RO#: P&amp;A CODE:            DATE: HOURS:            MILEAGE:</p>	<p style="text-align: center;">DEALER VALIDATION:</p> <p>RO#: P&amp;A CODE:            DATE: HOURS:            MILEAGE:</p>
<p style="text-align: center;">DEALER VALIDATION:</p> <p>RO#: P&amp;A CODE:            DATE: HOURS:            MILEAGE:</p>	<p style="text-align: center;">DEALER VALIDATION:</p> <p>RO#: P&amp;A CODE:            DATE: HOURS:            MILEAGE:</p>
<p style="text-align: center;">DEALER VALIDATION:</p> <p>RO#: P&amp;A CODE:            DATE: HOURS:            MILEAGE:</p>	<p style="text-align: center;">DEALER VALIDATION:</p> <p>RO#: P&amp;A CODE:            DATE: HOURS:            MILEAGE:</p>
<p style="text-align: center;">DEALER VALIDATION:</p> <p>RO#: P&amp;A CODE:            DATE: HOURS:            MILEAGE:</p>	<p style="text-align: center;">DEALER VALIDATION:</p> <p>RO#: P&amp;A CODE:            DATE: HOURS:            MILEAGE:</p>

## Scheduled Maintenance

### SPECIAL OPERATING CONDITIONS

If you operate your vehicle **primarily** in any of the following conditions, you need to perform additional maintenance as indicated. If you **occasionally** operate your vehicle under any of these conditions, it is not necessary to perform the additional maintenance. For specific recommendations, see your dealership service advisor or technician.

<b>Towing a trailer or using a camper or car-top carrier</b>	
As required	Change engine oil and filter as indicated by message center and perform services listed in Normal Scheduled Maintenance chart
Inspect frequently, service as required	Inspect and lubricate U-joints
	See axle maintenance items under <i>Exceptions</i>
Reset your oil life monitor system after each engine oil and filter change; refer to the <i>Instrument Cluster</i> chapter	
<b>Extensive idling and/or low-speed driving for long distances as in heavy commercial use (i.e. delivery, taxi, patrol car or livery)</b>	
As required	Change engine oil and filter as indicated by message center and perform services listed in Normal Scheduled Maintenance chart (except Fiesta)
Inspect frequently, service as required	Replace cabin air filter (if equipped)
	Replace engine air filter (except Fusion Hybrid and MKZ Hybrid) <sup>1</sup>
Every 300 hours of engine operation <sup>2</sup>	Change engine oil and filter (Fiesta)
Every 60,000 miles (96,000 km)	Replace spark plugs
<sup>1</sup> Fusion Hybrid and MKZ Hybrid vehicles have an engine air filter that does not normally require replacement. Refer to <i>Air filter</i> in the <i>Maintenance and Specifications</i> chapter for more information.	
<sup>2</sup> Engine hour meter installation is recommended for these conditions	
Reset your oil life monitor system after each engine oil and filter change; refer to the <i>Instrument Cluster</i> chapter	

## Scheduled Maintenance

<b>Operating in dusty or sandy conditions such as unpaved or dusty roads</b>	
Inspect frequently, service as required	Replace cabin air filter (if equipped)
	Replace engine air filter (except Fusion Hybrid and MKZ Hybrid)*
Every 5,000 miles (8,000 km)	Inspect the wheels and related components for abnormal noise, wear, looseness or drag
	Rotate tires, inspect tires for wear and measure tread depth
Every 5,000 miles (8,000 km) or 6 months	Change engine oil and filter
* Fusion Hybrid and MKZ Hybrid vehicles have an engine air filter that does not normally require replacement. Refer to <i>Air filter</i> in the <i>Maintenance and Specifications</i> chapter for more information.	
Reset your oil life monitor system after each engine oil and filter change; refer to the <i>Instrument Cluster</i> chapter	
<b>Exclusive use of E85 (Flex Fuel Vehicles only)</b>	
Every oil change	If ran exclusively on E85, fill the fuel tank full with regular unleaded fuel

## Scheduled Maintenance

### Special Operating Condition Log

<p style="text-align: center;">DEALER VALIDATION:</p>  <p style="text-align: center;">P&amp;A CODE:</p> <p>RO#:            HOURS:</p> <p>DATE:          MILEAGE:</p>	<p style="text-align: center;">DEALER VALIDATION:</p>  <p style="text-align: center;">P&amp;A CODE:</p> <p>RO#:            HOURS:</p> <p>DATE:          MILEAGE:</p>
<p style="text-align: center;">DEALER VALIDATION:</p>  <p style="text-align: center;">P&amp;A CODE:</p> <p>RO#:            HOURS:</p> <p>DATE:          MILEAGE:</p>	<p style="text-align: center;">DEALER VALIDATION:</p>  <p style="text-align: center;">P&amp;A CODE:</p> <p>RO#:            HOURS:</p> <p>DATE:          MILEAGE:</p>
<p style="text-align: center;">DEALER VALIDATION:</p>  <p style="text-align: center;">P&amp;A CODE:</p> <p>RO#:            HOURS:</p> <p>DATE:          MILEAGE:</p>	<p style="text-align: center;">DEALER VALIDATION:</p>  <p style="text-align: center;">P&amp;A CODE:</p> <p>RO#:            HOURS:</p> <p>DATE:          MILEAGE:</p>
<p style="text-align: center;">DEALER VALIDATION:</p>  <p style="text-align: center;">P&amp;A CODE:</p> <p>RO#:            HOURS:</p> <p>DATE:          MILEAGE:</p>	<p style="text-align: center;">DEALER VALIDATION:</p>  <p style="text-align: center;">P&amp;A CODE:</p> <p>RO#:            HOURS:</p> <p>DATE:          MILEAGE:</p>
<p style="text-align: center;">DEALER VALIDATION:</p>  <p style="text-align: center;">P&amp;A CODE:</p> <p>RO#:            HOURS:</p> <p>DATE:          MILEAGE:</p>	<p style="text-align: center;">DEALER VALIDATION:</p>  <p style="text-align: center;">P&amp;A CODE:</p> <p>RO#:            HOURS:</p> <p>DATE:          MILEAGE:</p>

## Scheduled Maintenance

<p style="text-align: center;">DEALER VALIDATION:</p>  <p style="text-align: center;">P&amp;A CODE:</p> <p>RO#:                    HOURS:</p> <p>DATE:                  MILEAGE:</p>	<p style="text-align: center;">DEALER VALIDATION:</p>  <p style="text-align: center;">P&amp;A CODE:</p> <p>RO#:                    HOURS:</p> <p>DATE:                  MILEAGE:</p>
<p style="text-align: center;">DEALER VALIDATION:</p>  <p style="text-align: center;">P&amp;A CODE:</p> <p>RO#:                    HOURS:</p> <p>DATE:                  MILEAGE:</p>	<p style="text-align: center;">DEALER VALIDATION:</p>  <p style="text-align: center;">P&amp;A CODE:</p> <p>RO#:                    HOURS:</p> <p>DATE:                  MILEAGE:</p>
<p style="text-align: center;">DEALER VALIDATION:</p>  <p style="text-align: center;">P&amp;A CODE:</p> <p>RO#:                    HOURS:</p> <p>DATE:                  MILEAGE:</p>	<p style="text-align: center;">DEALER VALIDATION:</p>  <p style="text-align: center;">P&amp;A CODE:</p> <p>RO#:                    HOURS:</p> <p>DATE:                  MILEAGE:</p>
<p style="text-align: center;">DEALER VALIDATION:</p>  <p style="text-align: center;">P&amp;A CODE:</p> <p>RO#:                    HOURS:</p> <p>DATE:                  MILEAGE:</p>	<p style="text-align: center;">DEALER VALIDATION:</p>  <p style="text-align: center;">P&amp;A CODE:</p> <p>RO#:                    HOURS:</p> <p>DATE:                  MILEAGE:</p>
<p style="text-align: center;">DEALER VALIDATION:</p>  <p style="text-align: center;">P&amp;A CODE:</p> <p>RO#:                    HOURS:</p> <p>DATE:                  MILEAGE:</p>	<p style="text-align: center;">DEALER VALIDATION:</p>  <p style="text-align: center;">P&amp;A CODE:</p> <p>RO#:                    HOURS:</p> <p>DATE:                  MILEAGE:</p>

## Scheduled Maintenance

### EXCEPTIONS

There are several exceptions to the Normal Schedule. They are listed below:

**Normal vehicle axle maintenance:** Rear axles and power take-off (PTO) units with synthetic fluid and light-duty trucks equipped with Ford-design axles are lubricated for life; do not check or change fluid unless a leak is suspected, service is required or the assembly has been submerged in water. During long periods of trailer towing with outside temperatures above 70°F (21°C) and at wide-open throttle for long periods above 45 mph (72 km/h), non-synthetic rear axle fluids should be changed every 3,000 miles (4,800 km) or three months, whichever comes first. This interval can be waived if the axle is filled with 75W140 synthetic gear fluid meeting Ford specification WSL-M2C192-A, part number F1TZ-19580-B or equivalent. Add friction modifier XL-3 (EST-M2C118-A) or equivalent for complete refill of Traction-Lok rear axles (refer to *Maintenance product specifications and capacities* in the *Maintenance and Specifications* chapter for details).

**Police/Taxi/Livery vehicle axle maintenance:** Change rear axle fluid every 100,000 miles (160,000 km). Rear axle fluid change may be waived if the axle was filled with 75W140 synthetic gear fluid meeting Ford specification WSL-M2C192-A, part number FITZ-19580-B or equivalent. Add four ounces (118 mL) of additive friction modifier XL-3 (EST-M2C118-A) or equivalent for complete refill of Traction-Lok rear axles. The axle fluid should be changed anytime the axle has been submerged in water.

**California fuel filter replacement:** If the vehicle is registered in California, the California Air Resources Board has determined that the failure to perform this maintenance item will not nullify the emission warranty or limit recall liability prior to the completion of the vehicle's useful life. Ford Motor Company, however, urges you to have all recommended maintenance services performed at the specified intervals and to record all vehicle service.

**Class A Motorhome:** Change brake fluid every two years.

**Hot climate oil change intervals:** Vehicles operating in the Middle East, North Africa, Sub-Saharan Africa or locations with similar climates using an American Petroleum Institute (API) Certified for Gasoline Engines (Certification mark) oil of SM or SN quality, the normal oil change interval is 5,000 miles (8,000 km). If the available API "SM" or "SN" oils are not available, then the oil change service interval is 3,000 mile (4,800 km).



## Scheduled Maintenance

**Edge/MKX AWD only** – vehicles operating off-road in sand during high ambient temperatures must replace the AWD PTU (All-wheel drive Power Transfer Unit) lube every 20,000 miles (32,000 km).

**Engine air filter & cabin air filter replacement:** Engine air filter and cabin air filter life is dependent on exposure to dusty and dirty conditions. Vehicles operated in these conditions will require frequent inspection and replacement of the engine air filter and cabin air filter.

### ENGINE COOLANT CHANGE RECORD

Initial change	6 years or 100,000 miles (160,000 km) (whichever comes first)
After initial change	Every 3 years or 50,000 miles (80,000 km)

### Engine Coolant Change Log

<p style="text-align: center;">DEALER VALIDATION:</p>  <p style="text-align: center;">P&amp;A CODE:</p> <p>RO#:            HOURS:</p> <p>DATE:           MILEAGE:</p>	<p style="text-align: center;">DEALER VALIDATION:</p>  <p style="text-align: center;">P&amp;A CODE:</p> <p>RO#:            HOURS:</p> <p>DATE:           MILEAGE:</p>
<p style="text-align: center;">DEALER VALIDATION:</p>  <p style="text-align: center;">P&amp;A CODE:</p> <p>RO#:            HOURS:</p> <p>DATE:           MILEAGE:</p>	<p style="text-align: center;">DEALER VALIDATION:</p>  <p style="text-align: center;">P&amp;A CODE:</p> <p>RO#:            HOURS:</p> <p>DATE:           MILEAGE:</p>
<p style="text-align: center;">DEALER VALIDATION:</p>  <p style="text-align: center;">P&amp;A CODE:</p> <p>RO#:            HOURS:</p> <p>DATE:           MILEAGE:</p>	<p style="text-align: center;">DEALER VALIDATION:</p>  <p style="text-align: center;">P&amp;A CODE:</p> <p>RO#:            HOURS:</p> <p>DATE:           MILEAGE:</p>

## Index

- 911 Assist™ .....69
- A**
- Accessing call history/phone book during active call .....52
- Accessing your media menu features .....80
- Accessing your phone menu features .....56
- Active call menu options .....52
- Advanced menu options .....64, 86
- Advanced menu options (prompts, languages, defaults, master reset, installing applications) .....64
- AdvanceTrac .....243
- Airbag supplemental restraint system .....170, 179, 182
- and child safety seats .....172
- description .....170, 179, 182
- disposal .....185
- driver airbag .....172, 180, 183
- indicator light .....179, 185
- operation .....172, 180, 183
- passenger airbag .....172, 180, 183
- side airbag .....179
- Air cleaner filter .....320–321, 324
- Ambient mood/lighting .....109
- Antifreeze (see Engine coolant) .....302
- Anti-lock brake system (see Brakes) .....241
- Anti-theft system .....144, 146
- arming the system .....145–146
- disarming a triggered system .....146
- triggering .....146
- AppLink™ .....74
- Armrests .....151
- Audio system (see Radio) ...24, 29
- Automatic transmission ....249, 251
- driving an automatic overdrive .....249
- fluid, adding .....319
- fluid, checking .....319
- Auxiliary input jack (Line in) ....33
- Auxiliary powerpoint .....121
- B**
- Battery .....300
- acid, treating emergencies ....300
- jumping a disabled battery ....274
- maintenance-free .....300
- replacement, specifications ...324
- servicing .....300
- Belt-Minder® .....165
- Blind spot mirror .....256
- Booster seats .....200
- Brakes .....240–241
- anti-lock .....241
- anti-lock brake system (ABS) warning light .....241
- fluid, checking and adding ....319
- fluid, refill capacities .....325
- fluid, specifications .....325
- lubricant specifications .....325
- parking .....242
- shift interlock .....247
- Break-in period .....5
- Bulbs .....110
- C**
- Capacities for refilling fluids ....325

## Index

- Cell phone use .....8
- Changing a tire .....268
- Child safety seats .....190
  - attaching with tether straps ..197
  - in front seat .....191
  - in rear seat .....191
  - LATCH .....194
  - recommendations .....188
- Child safety seats - booster seats .....200
- Cleaning your vehicle
  - engine compartment .....289
  - instrument panel .....291
  - interior .....292
  - plastic parts .....290
  - washing .....287
  - waxing .....287
  - wheels .....288
  - wiper blades .....290
- Clock .....20, 24, 29
- Clutch
  - fluid .....319
  - operation while driving .....252
  - recommended shift speeds ....252
- Connecting a digital media player to SYNC® .....76
- Console .....121
- Controls
  - steering column .....128
- Coolant
  - checking and adding .....302
  - refill capacities .....306, 325
  - specifications .....325
- Cruise control (see Speed control) .....126
- Customer Assistance .....258
  - Ford Extended Service Plan .....333, 336
  - Getting assistance outside the U.S. and Canada .....283
  - Getting roadside assistance ...258
  - Getting the service you need .....279
  - Ordering additional owner's literature .....285
  - Utilizing the Mediation/Arbitration Program .....283
- D**
- Daytime running lamps (see Lamps) .....106
- Dipstick
  - automatic transmission
    - fluid .....319
    - engine oil .....298
- Doors
  - central unlocking .....134
- Driving under special conditions .....251
  - through water .....257
- E**
- Electronic message center .....18
- Emergencies, roadside
  - jump-starting .....274
  - running out of fuel .....273, 311
- Emission control system .....316
- End user license agreement .....93
- Engine .....327–328
  - cleaning .....289

## Index

- coolant .....302
- idle speed control .....300
- lubrication specifications .....325
- refill capacities .....325
- service points .....296–297
- Engine block heater .....239
- Engine fan .....296
- Engine oil .....298
  - checking and adding .....298
  - dipstick .....298
  - filter, specifications .....299, 324
  - recommendations .....299
  - refill capacities .....325
  - specifications .....325
- Event data recording .....6
- Exhaust fumes .....238
- F**
- Fan, Engine Cooling .....294, 296
- Floor mats .....129, 131
- Fluid capacities .....325
- Fuel .....307
  - calculating fuel economy .....313
  - cap .....309
  - capacity .....325
  - choosing the right fuel .....310
  - detergent in fuel .....311
  - filler funnel .....311
  - filling your vehicle with
    - fuel .....307, 309, 313
    - filter, specifications .....307, 324
    - fuel pump shut-off .....260
    - improving fuel economy .....313
    - octane rating .....310, 327–328
    - quality .....311
    - running out of fuel .....273, 311
    - safety information relating to automotive fuels .....307
- Fuel and distance computer .....18
- outside temperature indicator .....18
  - to empty indicator .....18
  - trip distance .....18
  - trip/reset button .....18
- Fuses .....260–261
- G**
- Gas cap (see Fuel cap) .....309
- Gas mileage (see Fuel economy) .....313
- Gauges .....17
  - odometer .....18
  - trip odometer .....18
- H**
- Hazard flashers .....259
- Headlamps .....105
  - aiming .....106
  - bulb specifications .....110
  - daytime running lights .....106
  - high beam .....105
  - replacing bulbs .....111
  - turning on and off .....105
- Head restraints .....147
- Heating
  - heating and air conditioning system .....101
- Hill start assist .....254
- Hood .....295
- I**
- Ignition .....233, 327–328
- Infant seats (see Safety seats) .....190

## Index

- Inspection/maintenance (I/M) testing .....318
- Instrument panel  
  cleaning .....291  
  cluster .....12  
  lighting up panel and interior .....106
- Intelligent Access Key .....132
- Intelligent Access with push button start .....138
- J**
- Jack .....268  
  positioning .....268  
  storage .....268
- Joining two calls (multiparty/conference call) .....52
- Jump-starting your vehicle .....274
- K**
- Keyless entry system  
  autolock .....134–135
- Keys .....131, 146  
  positions of the ignition .....233
- L**
- Lamps  
  bulb replacement specifications chart .....110  
  daytime running light .....106  
  headlamps .....105  
  instrument panel, dimming ...106  
  interior lamps .....108–109, 111  
  replacing bulbs .....111
- LATCH anchors .....194
- Lights, warning and indicator ....12  
  anti-lock brakes (ABS) .....241
- Load limits .....224
- Locks  
  autolock .....134–135  
  childproof .....136
- Lubricant specifications .....325
- Lug nuts .....273
- M**
- Manual transmission .....252  
  fluid capacities .....325  
  lubricant specifications .....325  
  reverse .....253
- Media Bluetooth menu options (adding, connecting, deleting, turning on/off) .....85
- Media menu layout .....79
- Message center .....18  
  warning messages .....20
- Mirrors .....124–125  
  automatic dimming rearview mirror .....124  
  heated .....125  
  side view mirrors (power) ....125  
  signal .....126
- Moon roof .....128
- Motorcraft® parts .....293, 324
- O**
- Octane rating .....310
- Oil (see Engine oil) .....298
- P**
- Pairing other phones .....49
- Pairing your phone for the first time .....48

## Index

- Parking brake .....242
- Parts (see Motorcraft® parts) .....324
- Passenger Occupant Classification Sensor .....157
- Phone Bluetooth menu options (adding, connecting, deleting, turning on/off) .....63
- Phone dependent features .....47
- Phone menu layout .....55
- Phone redial .....56
- Playing music (by artist, album, genre, playlist, tracks, similar) .....81
- Power distribution box (see Fuses) .....264
- Power door locks .....133
- Power mirrors .....125
- Powerpoint .....121
- Power steering .....246–247
- Power Windows .....122
- Privacy information .....44
- Push button start system .....236
- Putting a call on/off hold .....52
- R**
- Radio .....24, 29
- Receiving a text message .....58
- Recommendations for attaching safety restraints for children .....188
- Relays .....260
- Remote entry system .....138  
illuminated entry .....144
- locking/unlocking doors .....140
- opening the trunk .....140
- replacement/additional transmitters .....142, 144
- replacing the batteries .....140
- Roadside assistance .....258
- S**
- Safety belts (see Safety restraints) .....159, 161–162, 164
- Safety defects, reporting .....286
- Safety information .....44
- Safety restraints .....159, 161–162, 164  
Belt-Minder® .....165  
extension assembly .....164  
for adults .....161–162  
for children .....186  
Occupant Classification Sensor .....157  
warning light and chime .....165
- Safety restraints - LATCH anchors .....194
- Safety seats for children .....190
- Safety Compliance Certification Label .....328
- Satellite Radio Information .....39
- Scheduled Maintenance Guide  
Normal Scheduled Maintenance and Log .....343
- Seats .....147  
child safety seats .....190  
heated .....152
- SecuriLock passive anti-theft system .....144
- Selecting your media source (USB, Line in, BT audio) .....80
- 358

<https://www.MyCarManual.com>

## Index

- Service your vehicle .....294
- Setting the clock .....20, 24, 29
- Side air curtain .....182
- SOS Post Crash Alert .....185
- Spark plugs,  
specifications .....324, 327–328
- Specification chart,  
lubricants .....325
- Speed control .....126
- Starting your  
vehicle .....233–234, 236
  - jump starting .....274
  - push button start system .....236
- Steering
  - speed sensitive .....247
- Steering wheel
  - controls .....128
  - tilting .....121
- SYNC® AppLink™ .....74
- SYNC® customer support .....93
- SYNC® .....42
- SYNC® Services .....66
- T**
- Text messaging .....58
- Text messaging (sending,  
downloading, deleting) .....58, 60
- Tilt steering wheel .....121
- Tire Pressure Monitoring  
System (TPMS)
  - Tires, Wheels and Loading ....220
- Tires .....205–206, 268
  - alignment .....214
  - care .....209
  - changing .....268, 270
  - checking the pressure .....209
  - inflating .....207
  - label .....219
  - replacing .....211
  - rotating .....214
  - safety practices .....213
  - sidewall information .....215
  - snow tires and chains .....224
  - spare tire .....268
  - terminology .....206
  - tire grades .....206
  - treadwear .....205, 210
- Towing .....230
  - recreational towing .....230
  - trailer towing .....230
  - wrecker .....277
- Traffic, Directions and  
Information .....66
- Transmission
  - automatic operation .....249
  - brake-shift interlock (BSI) ....247
  - fluid, checking and adding  
(automatic) .....319
  - fluid, checking and adding  
(manual) .....320
  - fluid, refill capacities .....325
  - lubricant specifications .....325
  - manual operation .....252
- Trunk
  - remote release .....140
- Turn signal .....108
- U**
- USB port .....35
- Using privacy mode .....52
- V**
- Vehicle health report .....72

## Index

Vehicle Identification Number (VIN) .....	329	Washer fluid .....	297
Vehicle loading .....	224	Water, Driving through .....	257
Ventilating your vehicle .....	238	Windows	
Voice commands in media mode .....	77	power .....	122
Voice commands in phone mode .....	50	rear wiper/washer .....	120
<b>W</b>		Windshield washer fluid and wipers	
Warning lights (see Lights) .....	12	checking and adding fluid .....	297
		operation .....	120
		replacing wiper blades .....	297
		Wrecker towing .....	277